

**FREEDOM OF INFORMATION
AND
PRIVACY ACTS**

**SUBJECT: BIRMINGHAM, ALABAMA SIXTEENTH
STREET BAPTIST CHURCH
BOMBING/SEPTEMBER 15, 1963**

PART 5 OF 11



FEDERAL BUREAU OF INVESTIGATION

NOTICE

THE BEST COPIES OBTAINABLE ARE INCLUDED IN THE REPRODUCTION OF THE FILE. PAGES INCLUDED THAT ARE BLURRED, LIGHT OR OTHERWISE DIFFICULT TO READ ARE THE RESULT OF THE CONDITION AND OR COLOR OF THE ORIGINALS PROVIDED. THESE ARE THE BEST COPIES AVAILABLE.

FEDERAL BUREAU OF INVESTIGATION
FREEDOM OF INFORMATION/PRIVACY ACTS SECTION
COVER SHEET

SUBJECT: BIRMINGHAM, ALABAMA
SIXTEENTH STREET BAPTIST CHURCH
BOMBING/SEPTEMBER 15, 1963

PART 5 OF 11

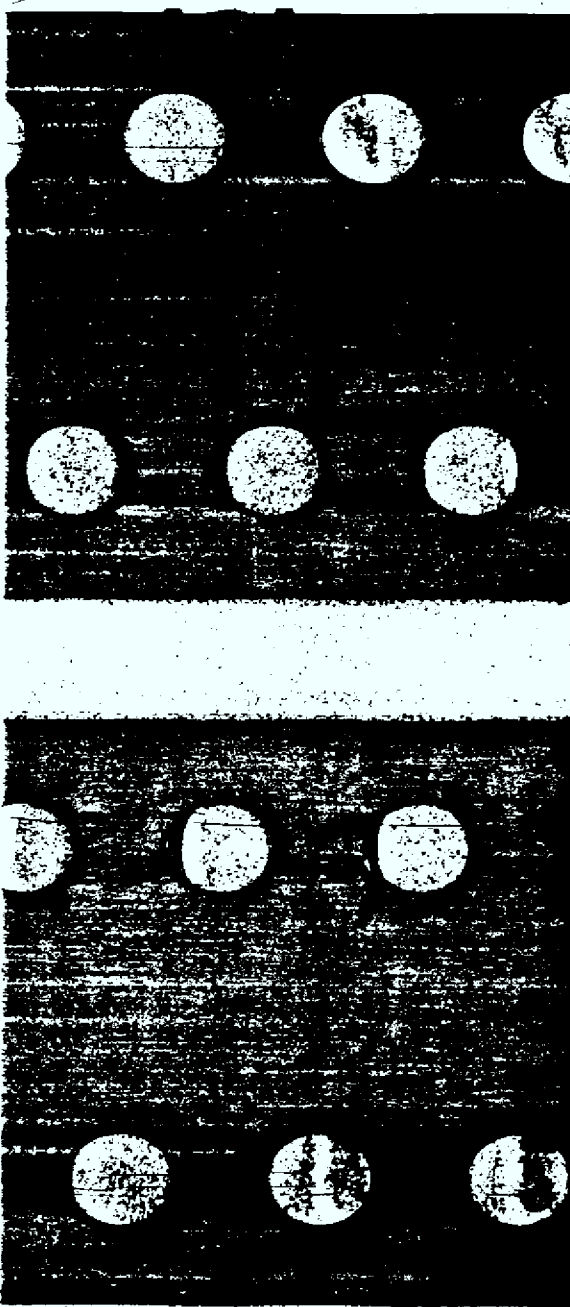

ION

0-9 (Rev. 2-14-61)

Invoice of Contents from
FEDERAL BUREAU OF INVESTIGATION
WASHINGTON, D. C.

November 22, 1963

RAPBOMB

Date SAC, Birmingham

Case 157-333 References

Consigned to: 157-1025

Letter 11/8/63

MAILED 4
NOV 26 1963
COMM-FBI

List of Contents

11/22 PC-78090 CW IJ GH

Returned

11-26-63

716227

Registered Mail

- Crypt.-Trans.
- Document
- Electronics
- Physics-Chemistry
- LFPS

SPECIAL INSTRUCTIONS: Mail Room, place date of shipment and registry number, Shipping Room, show date of shipment, bill of lading number and initial this invoice; then return it to section checked in column at right. After this has been initialed, invoice should be placed in administrative file.

6 NOV 29 1963
file

[Handwritten signature]

650
PAGE TWO

[REDACTED]

SEVERAL MEMBERS OF TUSCALOOSA KLAVERN NUMBER FIVE, UKA, KKKK, AND MEMBERS OF BERRY KLAVERN OF THE UKA, INC., KKKK, INTERVIEWED THIS DATE. NO INFORMATION DEVELOPED CONCERNING BAPBOMB BUT MUCH INTELLIGENCE INFORMATION DEVELOPED AS TO PAST ACTIVITIES OF THESE TWO KLAVERNS. MOST PERSONS INTERVIEWED, WHILE REFUSING TO BE INTERVIEWED, ANSWERED QUESTIONS AND SUBMITTED TO BEING PHOTOGRAPHED. IN FACT, IN NO INSTANCE WAS THERE A REFUSAL.

ASTERISK INFORMANTS FURNISHED MUCH INTELLIGENCE INFORMATION DURING PAST TWENTYFOUR HOURS BUT NOTHING THAT POINTED DIRECTLY TOWARD THE BOMBINGS UNDER INVESTIGATION. ALL LIVE INFORMANTS CONTACTED AND WHILE THEY HAVE BEEN IN TOUCH WITH SOME OF THE PRINCIPALS WERE UNABLE TO REPORT ANYTHING NEW.

FIFTYFIVE INTERVIEWS TODAY. ONE HUNDRED NINETYSEVEN PENDING.

END

WA 11-12 PM OK FBI WA JS

RA
97

FEDERAL BUREAU OF INVESTIGATION

REPORTING OFFICE BIRMINGHAM	OFFICE OF ORIGIN BIRMINGHAM	DATE 11/15/63	INVESTIGATIVE PERIOD 9/25/63 - 11/14/63
TITLE OF CASE UNKNOWN SUBJECTS; Bombing of 16th Street Baptist Church, Birmingham, Alabama, 9/15/63		REPORT MADE BY SA [REDACTED]	TYPED BY yk
		CHARACTER OF CASE BOMBING MATTERS <i>az</i>	

REFERENCE: Report of SA [REDACTED] dated 11/1/63 at Birmingham.

- P - ALL INFORMATION CONTAINED
HEREIN IS UNCLASSIFIED
DATE 8-27-86 BY SP4E/W/EO

ENCLOSURE: TO THE BUREAU (3):

Three (3) copies of FD-302 interview with [REDACTED] marked obscene.

LEADS

An information copy is furnished Mobile because of its mutual interest in racial and bombing matters throughout the state of Alabama.

47c
12-16-63
ENCL. Behind file

ADMINISTRATIVE

No leads are being set out in this report inasmuch as all leads have been set out on an expedite basis and this practice will continue.

APPROVED <i>[Signature]</i>	SPECIAL AGENT IN CHARGE	DO NOT WRITE IN SPACES BELOW
COPIES MADE:	157-1025-1663	REC-48
3 - Bureau (157-1025) (Enc. 3)	ENCLOSURE	REC-26
1 - Mobile (Info)	ENCLOSURE ATTACHED	NOV 26 1963
1 - Birmingham (157-352)	XEROX	NOV 27 1963
1 - Birmingham (157-352)	NOV 26 1963	NOV 27 1963
MINIMUM COPIES OF ATTACHED REPORT	NOTATIONS	STANLEY
AGENCY DATE	Crim. Div	6-26-64
DATE FILED	6-24-64	6-24-64
BY		

66 DEC 1963

BH 157-352

An additional copy is furnished to the Bureau in the event it is needed for dissemination.

This report includes material on stencil which had been run off as of 11/14/63 and does not intend to reflect all investigation conducted prior to 11/14/63.

Any reference herein to Klan, KKK, Ku Klux Klan, Knights of the Ku Klux Klan, or any similar designation shall be construed as referring to United Klans of America, Inc., Knights of the Ku Klux Klan, unless otherwise qualified.

No index is being supplied at this time but will be furnished at a later date.

Numerous negative informant contacts from auxiliary offices have been received and are included in the Birmingham file but are not being set out in the report.

Investigation regarding the shrapnel bombing of 9/25/63 in Birmingham, relative to the clutch hub assembly piece which was found in the crime scene search, and other investigation is being incorporated in this report because all suspects are being interviewed regarding all Birmingham bombings and the inclusion of the specific material relative to the shrapnel bombing furnishes an over-all picture of investigation and eliminates duplication of reporting. It should be noted that copies of any investigation which are pertinent to a specific bombing are being channelized to those specific files.

Only the original and four copies of the FD-302 setting out the statement of [redacted] submitted as an enclosure to this report and marked obscene, are prepared as Birmingham is in possession of signed statement which can be more easily stored, and there is no reason for having copies attached for the Birmingham file.

42010

B

BH 157-352

1

POLYGRAPH MATTERS

All polygraph examinations described below were given Bureau approval by Assistant Director ROSEN in telephone conversations with SAC ROY K. MOORE. They were conducted by SA [redacted]. In addition to interviews reported, authority was also granted to interview klansmen [redacted] and [redacted] but they declined to be interviewed with the aid of a polygraph. [redacted]

Ala.

[Large redacted area covering the majority of the page content]

67-10

c

UNITED STATES DEPARTMENT OF JUSTICE
FEDERAL BUREAU OF INVESTIGATION

247,392
ALL INFORMATION CONTAINED
HEREIN IS UNCLASSIFIED
DATE 2-27-86 BY SP4 Ew/Ew

Copy to: 259

Report of:

[REDACTED]

Office: Birmingham

Date:

11/15/63

Field Office File #:

157-352

Bureau File #:

157-1025

Title:

UNKNOWN SUBJECTS; BOMBING OF
SIXTEENTH STREET BAPTIST CHURCH,
BIRMINGHAM, ALABAMA, SEPTEMBER 15, 1963

Character:

BOMBING MATTERS

Synopsis:

Piece of shrapnel from 9/25/63 bombing, Birmingham, identified as portion of clutch hub assembly for 1940-42 Hudson automobile. Neighborhood investigation revealed one additional witness who believed she saw a light-blue station wagon pass by church moments before explosion. Main suspects and individuals close to them interviewed with additional personal information developed. Some evidence developed on main suspects of local criminal violations. Several alibis verified. Numerous present and former klansmen in Alabama interviewed. Background developed, but no positive information re captioned bombing.

67-10



[REDACTED]

All projects being afforded continuous attention. INVESTIGATION REFLECTS MANY MEMBERS OF KLAN AND SEGREGATION-TYPE GROUPS CARRY SOME TYPE OF WEAPON, ALL SUCH INDIVIDUALS ARE, THEREFORE, TO BE CONSIDERED ARMED AND EXTREMELY DANGEROUS.

-P-

BH 157-352

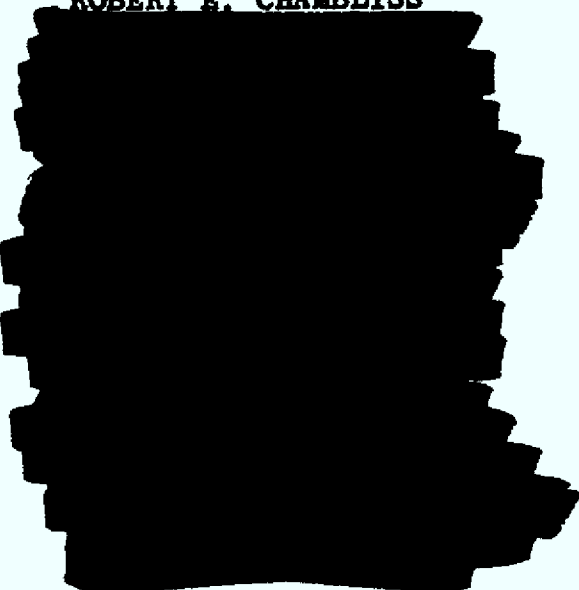
TABLE OF CONTENTS

	<u>Page</u>
1. Investigation re shrapnel bombing 9/25/63	2
2. Church and neighborhood	9
3. Main suspects	77
	78
	105
	110
	116
ROBERT E. CHAMBLISS	136
	142
	150
	152
	159
	167
	178
	180
	186
	187
	195
	203
	204
	224
	227
	231
	233
	235
	241
4. Other Klansmen	242
Signed statement of 	259
	305
5. NSRP	311
6. Other Suspects & Miscellaneous	319

62

INVESTIGATION RE
SHRAPNEL BOMBING
September 25, 1963

1

BH 157-407
BH 157-352
[REDACTED]

Search for Part of Hudson
Automobile Clutch Hub Assembly

On September 25, 1963, during the crime scene search following the explosion of two bombs at a junction of Center Street, 16th Street and 7th Avenue South, the largest metal fragments recovered were two fragments that appeared to be portions of a clutch plate. They were tentatively identified by local automobile parts dealers as parts of a clutch hub assembly from an old Hudson. These parts were sent to Detroit and thence to Milwaukee where they were identified as parts of a clutch hub assembly of a 1940, 1941, or 1942 Hudson. Details are set forth in interview of [REDACTED] conducted by SA [REDACTED]

67c
ID

[REDACTED]

On October 25, 1963, SA's [REDACTED] and [REDACTED] with the consent of [REDACTED] searched his garage, a number of old cars and panel trucks, and the grounds where [REDACTED] dismantles old or wrecked cars. A junk pile containing tons of junked auto parts was moved piece-by-piece. Numerous clutch plates were found but none similar to these Hudson parts which were being sought.

67c

On October 24 and 25, 1963, SA's [REDACTED] and [REDACTED] searched through several [REDACTED] junked [REDACTED]

67c

[REDACTED] Birmingham. [REDACTED]

One Hudson clutch plate for a 1952 Hudson was pointed out by [REDACTED]. The entire clutch hub assembly for this model was interchangeable with the 1940 to 1942 hub assemblies, but component parts are quite different, but the parts which were being sought were not

2

BH 157-407
BH 157-352

the same as the one recovered at the crime scene. [REDACTED]
advised that the last Hudson clutch he had sold was to [REDACTED]
[REDACTED] in June, 1963.

6219

[REDACTED]

[REDACTED]

[REDACTED]

On October 30, 1963, SA [REDACTED] with the consent
of owner [REDACTED] searched through a junk pile of trans-
mission parts on a lot behind [REDACTED]
[REDACTED] but found no parts of a standard shift clutch.
SA [REDACTED] also on October 30, 1963, searched through a
large junk yard and used auto parts place owned by [REDACTED]
[REDACTED] but found no parts similar to the Hudson clutch.

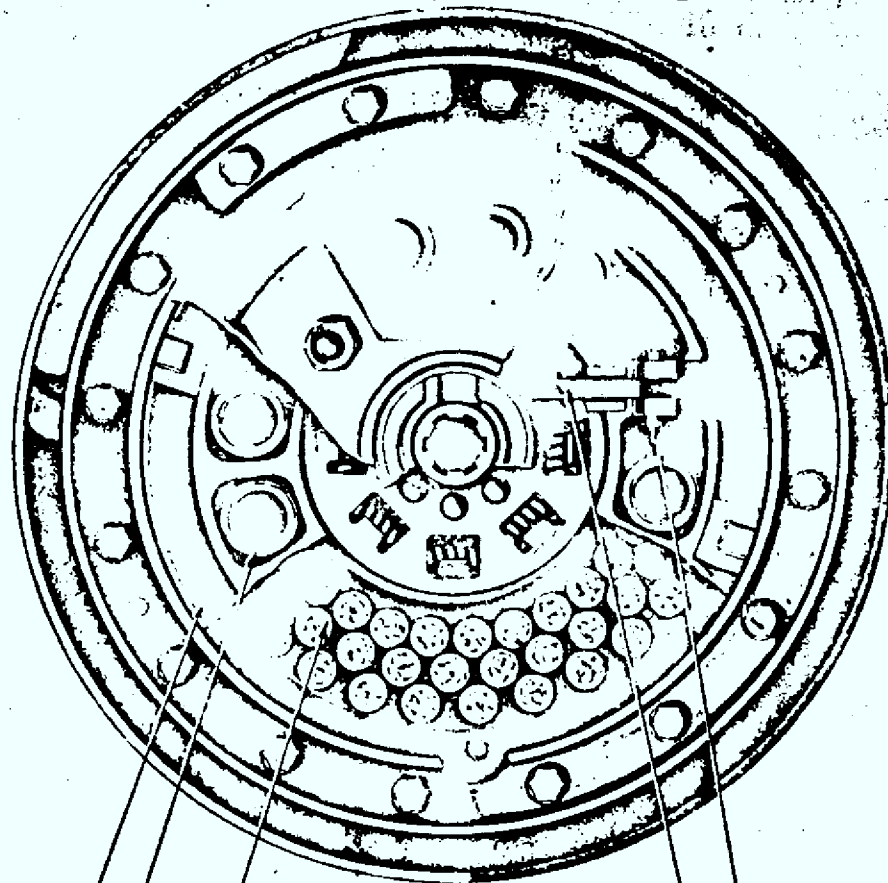

Clutch

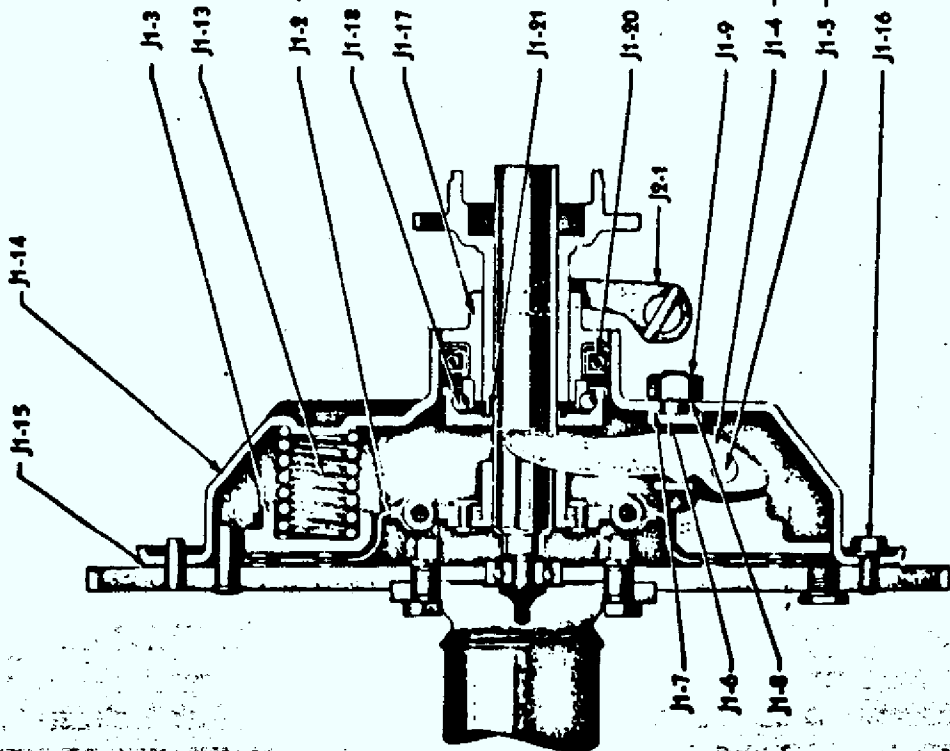

BH 157-352

CHURCH AND
NEIGHBORHOOD

BH 157-352

MAIN SUSPECTS

1

Date 11/2/63

Pictures of the 1960 Falcon Tudor Sedan owned by ROBERT E. CHAMBLISS, 2505 - 32nd Avenue North, Birmingham, Alabama, a suspect in the Birmingham, Alabama, bombings, were taken while the car was parked at 3rd Avenue North and 20th Street, Birmingham, Alabama. While the pictures were being taken, CHAMBLISS approached and objected to his car being photographed. CHAMBLISS' picture was also taken while he was on the street and also after he entered the car.

Robert

Robert Edward

APPROX 1930

R. E. Chambliss
Ga. Fla.

On 10/30/63 at Birmingham, Alabama File # BH 157-390
BH 157-352
by SA [redacted] Date dictated 10/30/63

This document contains neither recommendations nor conclusions of the FBI. It is the property of the FBI and is loaned to your agency; it and its contents are not to be distributed outside your agency.

136

BH 157-486
BH 157-352

[REDACTED]

63c
On October 9, 1963, [REDACTED] was observed in the Jefferson County Recorder's Court, Birmingham, Alabama, along with [REDACTED] and [REDACTED] during the local trial of ROBERT CHAMBLISS, CHARLES ARNIE CAGLE, and JOHN HALL for handling of dynamite. These individuals are prime suspects in investigation of the bombing of the Sixteenth Street Baptist Church. [REDACTED] was believed to be taking copious notes along with [REDACTED] and [REDACTED]

BH 157-352

OTHER KLANSMEN

242

BH 157-352

NSRP

310

BH 157-352

OTHER SUSPECTS AND
MISCELLANEOUS

319

XXXXXX
XXXXXX
XXXXXX

**FEDERAL BUREAU OF INVESTIGATION
FOIPA DELETED PAGE INFORMATION SHEET**

352 Page(s) withheld entirely at this location in the file. One or more of the following statements, where indicated, explain this deletion.

- Deleted under exemption(s) (b)(7)(C) and (D) with no segregable material available for release to you.
- Information pertained only to a third party with no reference to you or the subject of your request.
- Information pertained only to a third party. Your name is listed in the title only.
- Documents originated with another Government agency(ies). These documents were referred to that agency(ies) for review and direct response to you.

_____ Pages contain information furnished by another Government agency(ies). You will be advised by the FBI as to the releasability of this information following our consultation with the other agency(ies).

_____ Page(s) withheld for the following reason(s):

For your information: _____

The following number is to be used for reference regarding these pages:

157-1025-663

XXXXXX
XXXXXX
XXXXXX

XXXXXXXXXXXXXXXXXXXXX
X DELETED PAGE(S) X
X NO DUPLICATION FEE X
X FOR THIS PAGE X
XXXXXXXXXXXXXXXXXXXXX

XXXXXX
XXXXXX
XXXXXX

FEDERAL BUREAU OF INVESTIGATION FOIPA DELETED PAGE INFORMATION SHEET

2 Page(s) withheld entirely at this location in the file. One or more of the following statements, where indicated, explain this deletion.

Deleted under exemption(s) (b)(7)(D) with no segregable material available for release to you.

Information pertained only to a third party with no reference to you or the subject of your request.

Information pertained only to a third party. Your name is listed in the title only.

Documents originated with another Government agency(ies). These documents were referred to that agency(ies) for review and direct response to you.

_____ Pages contain information furnished by another Government agency(ies). You will be advised by the FBI as to the releasability of this information following our consultation with the other agency(ies).

_____ Page(s) withheld for the following reason(s):

For your information: _____

The following number is to be used for reference regarding these pages:
157-1025-664

XXXXXX
XXXXXX
XXXXXX

XXXXXXXXXXXXXXXXXXXXX
X DELETED PAGE(S) X
X NO DUPLICATION FEE X
X FOR THIS PAGE X
XXXXXXXXXXXXXXXXXXXXX

UNITED STATES GOVERNMENT

Memorandum

TO : DIRECTOR, FBI (157-1025)

DATE: 11/19/63

FROM : *[Signature]* SAC, KNOXVILLE (157-189) (P)

SUBJECT: BAPBOMB

Re Bureau airtel to Birmingham and Knoxville 10/25/63.

In addition to names of members of Dixie Klans, Knights of the Ku Klux Klan previously submitted, it is suggested that the fingerprints of

[Redacted]
print found in connection with the attempted bombing of the Jewish Temple Beth-El in Birmingham, Alabama, 4/28/58.

[Large redacted block]

pr lsc

EX-102

2 - Bureau
2 - Knoxville

[Redacted] *lsc*

REC 27 157-1025-2

11 NOV 21 1963

[Handwritten initials]

[Handwritten signature]

[Handwritten notes and stamps]
665
Ponder
BTH

Ans 12-4-63

JE B: *[Handwritten]*

NOV 22 1963
FBI
KNOXVILLE

EX-102
35

FEDERAL BUREAU OF INVESTIGATION

Washington, D. C. 20537

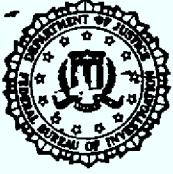

REPORT

LATENT FINGERPRINT SECTION

Identification Division

YOUR FILE NO. **157-189**
FBI FILE NO. **REC 37 157-1025 - 665**
LATENT CASE NO. **45563**

December 4, 1963

TO: **SAC, Knoxville**

RE: **BAPBOMB**

REFERENCE: **Letter 11-19-63**
EXAMINATION REQUESTED BY: **Knoxville**
SPECIMENS:

The latent fingerprints in the case "Unknown Subjects; Attempted Bombing of Jewish Synagogue Temple Beth-El, Birmingham, Ala., 4-28-59" are not identical with the fingerprints of [REDACTED]

- 2 - Birmingham
- 1 - Bufile (100-135-4)

JEB:HLN
(6)

67c

mt
Trice

COPIES 2 2 30
REC'D - BOSTON
181

100-135-4-1111

MAILED 27
DEC - 4 1963
COMM-FBI

RECEIVED DEPT. OF JUSTICE
DEC 2 15 40 PM '63

DEC 2 1963
FBI
REC'D - CIV RIGHTS

- Tolson
- Belmont
- Mohr
- Casper
- Callahan
- Conrad
- DeLoach
- Evans
- Gale
- Rosen
- Sullivan
- Tavel
- Trotter
- Tele. Room

[Handwritten initials]

17-229
53 DEC 2 1963

[Handwritten signature]
John Edgar Hoover, Director

FEDERAL BUREAU OF INVESTIGATION
LATENT FINGERPRINT SECTION WORK SHEET

Recorded: 11/29/63 11:00 A. M.

Reference No:

157-189

Received: 11/29/63 bcc

FBI File No:

157-1025 - 605

Latent Case No:

45563

Answer to: SAC, Knoxville

Examination requested by: Addressee

Copy to:

RE: BAPBOMB

Date of reference communication: Letter 11/19/63

Specimens:

Named suspect: [REDACTED]

lsc

*1-4
th*

Result of examination:

Examination by: Burke

Evidence noted by:

*Card index 11/29
Latent prints this case not ident prints
[REDACTED] 11/30*

bcc

Ans 12-4-63

JEB: hbn

Examination completed: *1155AM 11-30-63* Dictated: *11-30-63*
Time Date Date

UNITED STATES GOVERNMENT

Memorandum

Tolson	_____
Belmont	_____
Mohr	_____
Casper	_____
Callahan	_____
Conrad	_____
DeLoach	_____
Evans	_____
Malone	_____
Rosen	_____
Tavel	_____
Trotter	_____
Tele. Room	_____
Holmes	_____
Gandy	_____

3

TO :

Mr. Belmont

DATE: November 21, 1963

FROM :

A. Rosen

SUBJECT:

UNKNOWN SUBJECTS;
BOMBING OF SIXTEENTH
STREET BAPTIST CHURCH
BIRMINGHAM, ALABAMA
SEPTEMBER 15, 1963
BOMBING MATTERS

1-1
Bap bomb
rh

[REDACTED]

Additional members of the Tuscaloosa, Alabama, and Berry, Alabama, Klaverns of the United Klans of America, Inc., were interviewed on 11/20/63. No information concerning the recent Birmingham bombings was obtained.

[REDACTED]

- 1 - Mr. Mohr
- 1 - Mr. DeLoach
- 1 - Mr. Evans

EX-102

REC-44

157-1025-666

4 NOV 22 1963

— STA —

0 0

Memorandum for Mr. Belmont
RE: BAPBOMB

b7c, d

[REDACTED]

[REDACTED]

Alabama

[REDACTED]

ACTION:

You will be kept advised of pertinent developments.

gmc

SPM

SHB

V

[Signature]

AD

XXXXXX
XXXXXX
XXXXXX

FEDERAL BUREAU OF INVESTIGATION
FOIPA DELETED PAGE INFORMATION SHEET

1 Page(s) withheld entirely at this location in the file. One or more of the following statements, where indicated, explain this deletion.

Deleted under exemption(s) (b)(7)(C) & (D) with no segregable material available for release to you.

Information pertained only to a third party with no reference to you or the subject of your request.

Information pertained only to a third party. Your name is listed in the title only.

Documents originated with another Government agency(ies). These documents were referred to that agency(ies) for review and direct response to you.

_____ Pages contain information furnished by another Government agency(ies). You will be advised by the FBI as to the releasability of this information following our consultation with the other agency(ies).

_____ Page(s) withheld for the following reason(s):

For your information: _____

The following number is to be used for reference regarding these pages:
157-1025-667

XXXXXX
XXXXXX
XXXXXX

XXXXXXXXXXXXXXXXXXXXX
X DELETED PAGE(S) X
X NO DUPLICATION FEE X
X FOR THIS PAGE X
XXXXXXXXXXXXXXXXXXXXX

FEDERAL BUREAU OF INVESTIGATION

Washington, D. C. 20537



REPORT

of the

LATENT FINGERPRINT SECTION

Identification Division

YOUR FILE NO.
FBI FILE NO. **REC- 16 157-352**
LATENT CASE NO. **157-1025-667**
EX-103 45563

November 20, 1963

TO: **SAC, Birmingham**

RE: **RAPBOMB**

NOV 21 11 53 AM '63
FBI
REC'D - BIRMINGHAM

REFERENCE: **Letter 11-12-63**
EXAMINATION REQUESTED BY **Birmingham**
SPECIMENS: **Fingerprints of [REDACTED]**

bx
Latent fingerprints previously reported of value in case entitled "Unsub.; Attempted Bombing of Temple Beth-El Jewish Synagogue, 21st Way and Highland Avenue Birmingham, Ala., 4-23-58," Bufile 100-135-4, LC #15226, not identical with fingerprints of [REDACTED]

Fingerprints of [REDACTED] enclosed.

Enc.

- 1 - Birmingham
- 1 - Bufile(100-135-4)

FML:cjp
(6)

MAILED 25
NOV 20 1963
COMM-FBI

- Tolson _____
- Belmont _____
- Mohr _____
- Casper _____
- Callahan _____
- Conrad _____
- DeLoach _____
- Evans _____
- Gale _____
- Rosen _____
- Sullivan _____
- Tavel _____
- Trotter _____
- Tele. Room _____
- Holmes _____
- Gandy _____

J. Edgar Hoover
John Edgar Hoover, Director

NOV 29 1963

FEDERAL BUREAU OF INVESTIGATION
LATENT FINGERPRINT SECTION WORK SHEET

Recorded: 11/15/63 12:00 noon

Reference No: 157-352

Received: 11/15/63 bcc

FBI File No: 157-1025

Latent Case No: 45563

.667

Answer to: SAC, Birmingham

Examination requested by: Addressee

Copy to:

RE: BAPBOMB

Date of reference communication: Letter 11/12/63

Specimens:

Fingerprints

b2



[Handwritten signature]

Result of examination:

Examination by: Leapley

Evidence noted by:

Name check req 11-15 fml

*Comp - do of 11-19 fml (Bufile 100-135-4 ~~225~~)
LC 15226*

Prints released 11-19 fml

Examination completed: *10³⁰/A 11-19* Dictated: *11-19-63 fml*
Time Date Date

UNITED STATES GOVERNMENT

Memorandum

TO : Mr. Belmont

DATE: November 23, 1963

FROM : A. Rosen

Tolson	_____
Belmont	_____
Mohr	_____
Casper	_____
Callahan	_____
Conrad	_____
DeLoach	_____
Evans	_____
Gale	_____
Rosen	_____
Sullivan	_____
Tavel	_____
Trotter	_____
Tele. Room	_____
Holmes	_____
Gandy	_____

SUBJECT: UNKNOWN SUBJECTS;
 BOMBING OF 16th STREET
 BAPTIST CHURCH
 BIRMINGHAM, ALABAMA
 SEPTEMBER 15, 1963
 BOMBING MATTERS

On November 22, 1963, all suspects in the Birmingham bombing were located and contacted but none furnished any additional information of significance.

670

[REDACTED]

670

[REDACTED]

REC-48 157-1045-668 NOV 27 1963

Additional interviews of associates, friends and acquaintances of the suspects in this case were also conducted on 11/22/63 but no new evidence indicating their involvement in the Birmingham bombing was obtained.

JCT:ph (6) 2 1963

Memo Rosen to Belmont

ACTION:

You will be advised of pertinent developments.

1/18/53

Rosen

Q

NOV 22 1963
TELETYPE

Mr. Tolson	_____
Mr. Belmont	_____
Mr. Mohr	_____
Mr. Casper	_____
Mr. Callahan	_____
Mr. Conrad	_____
Mr. DeLoach	_____
Mr. Evans	_____
Mr. Gale	_____
Mr. Rosen	_____
Mr. Sullivan	_____
Mr. Tavel	_____
Mr. Trotter	_____
Tele. Room	_____
Miss Holmes	_____
Miss Gandy	_____

URGENT 11-22-63 2-58 PM EST BLR
 TO. DIRECTOR /157-1025/
 SAC-S BIRMINGHAM /157-352/ AND KNOXVILLE
 FROM. SAC, ATLANTA /157-582/

BAPBOMB.

McB...
Ad...

[REDACTED]

KNOXVILLE AND BIRMINGHAM COVER [REDACTED] ACTIVITIES
 THROUGH ESTABLISHED SOURCES AND ATLANTA WILL ADVISE OF FURTHER
 INFORMATION KNOWN CONCERNING TRAVEL. [REDACTED]

[REDACTED]

[REDACTED] HAS STATED HE WOULD SHOOT ANY
 FBI AGENT WHO SURVEILLED HIM.

END AND ACK PLS
 WA 3-020 PM OK FBI WA MET
 BH 2-00 PM OK FBI BH DLR
 KX 3-01 PM EST OK FBI KX JCH
 TU CLR
 MVUM

REC-19

157-1025-669

6 NOV 27 1963

cc. Mr. Mc Gowan

67510

PAGE TWO.

[REDACTED]

[REDACTED] ADDITIONAL FRIENDS, NEIGHBORS AND ACQUAINTANCES
OF PRINCIPAL SUSPECTS INTERVIEWED TO NO AVAIL.

SIXTYFOUR INTERVIEWS CONDUCTED TODAY. TWO HUNDRED TWENTYTWO
REMAINING.

END

10-15 PM OK FBI WA WS

CLRO

1964 SEP 11 10 11 AM
FBI - WASHINGTON

MAR 5 1964
FBI - WASHINGTON

Date of Mail 11-13-63

Has been removed and placed in the Special File Room of Records Branch.

See File 66-2554-7530 for authority.

Copies made by
for review by Task Force
Date 1-8-79

Subject JUNE MAIL Baybowl

BY
65 DEC 4 1963

Removed By _____

File Number 157-1025-671

XXXXXX
XXXXXX
XXXXXX

FEDERAL BUREAU OF INVESTIGATION
FOIPA DELETED PAGE INFORMATION SHEET

12

Page(s) withheld entirely at this location in the file. One or more of the following statements, where indicated, explain this deletion.

Deleted under exemption(s) (b)(7)(C), (D) and (E) with no segregable material available for release to you.

Information pertained only to a third party with no reference to you or the subject of your request.

Information pertained only to a third party. Your name is listed in the title only.

Documents originated with another Government agency(ies). These documents were referred to that agency(ies) for review and direct response to you.

_____ Pages contain information furnished by another Government agency(ies). You will be advised by the FBI as to the releasability of this information following our consultation with the other agency(ies).

_____ Page(s) withheld for the following reason(s):

For your information: _____

The following number is to be used for reference regarding these pages:
157-1025-671

XXXXXX
XXXXXX
XXXXXX

XXXXXXXXXXXXXXXXXXXXX
X DELETED PAGE(S) X
X NO DUPLICATION FEE X
X FOR THIS PAGE X
XXXXXXXXXXXXXXXXXXXXX

Date of Mail 11-13-63

Has been removed and placed in the Special File Room of Records Branch.

Handwritten: L... -1-8-79

See File 66-2554-7530 for authority.

Subject JUNE MAIL *Bop bomb*

377
65 DEC 4 1963

Removed By _____

File Number 157-1025-672

XXXXXX
XXXXXX
XXXXXX

FEDERAL BUREAU OF INVESTIGATION FOIPA DELETED PAGE INFORMATION SHEET

 1 Page(s) withheld entirely at this location in the file. One or more of the following statements, where indicated, explain this deletion.

- Deleted under exemption(s) (b)(7)(C) and (D) with no segregable material available for release to you.
- Information pertained only to a third party with no reference to you or the subject of your request.
- Information pertained only to a third party. Your name is listed in the title only.
- Documents originated with another Government agency(ies). These documents were referred to that agency(ies) for review and direct response to you.

 Pages contain information furnished by another Government agency(ies). You will be advised by the FBI as to the releasability of this information following our consultation with the other agency(ies).

 Page(s) withheld for the following reason(s):

For your information: _____

The following number is to be used for reference regarding these pages:
 152-1025-672

XXXXXX
XXXXXX
XXXXXX

XXXXXXXXXXXXXXXXXXXXX
X DELETED PAGE(S) X
X NO DUPLICATION FEE X
X FOR THIS PAGE X
XXXXXXXXXXXXXXXXXXXXX

UNITED STATES GOVERNMENT

Memorandum

Tolson	_____
Belmont	_____
Mohr	_____
Casper	_____
Callahan	_____
Conrad	_____
DeLoach	_____
Evans	_____
Gale	_____
Rosen	_____
Sullivan	_____
Trotter	_____
Tele. Room	_____
Holmes	_____
Gandy	_____

TO : Mr. Belmont

DATE: November 22, 1963

FROM : A. Rosen

SUBJECT: UNKNOWN SUBJECTS;
BOMBING OF SIXTEENTH
STREET BAPTIST CHURCH
BIRMINGHAM, ALABAMA
SEPTEMBER 15, 1963
BOMBING MATTERS

Additional present and past members of the Tuscaloosa, Alabama, and Berry, Alabama, Klaverns of United Klans of America, Inc., were interviewed on 11/21/63. No information concerning the recent Birmingham bombings was obtained.

[REDACTED]

[REDACTED]

Additional friends, neighbors and acquaintances of the principal suspects in this case were interviewed on 11/21/63; however, no pertinent information was obtained.

ACTION: You will be advised of pertinent developments.

- 1 - Mr. Mohr
- 1 - Mr. DeLoach
- 1 - Mr. Evans

REC-22

157-1025-693

NOV 27 1963

FBI

Date: 11/7/63

Transmit the following in _____
(Type in plain text or code)

Via AIRTEL AIR MAIL
(Priority or Method of Mailing)

TO: DIRECTOR, FBI (157-1025)
FROM: SAC, JACKSONVILLE (157-584)
SUBJECT: BAPBOMB
(JK file 157-584)

Joseph

67c [REDACTED]
RACIAL MATTERS
(JK file 157-28)

Re Bureau tel 11/1/63 and Jacksonville tels 11/4 and 6/63.

[REDACTED]

Shortly after noon on 11/4/63 [REDACTED] entered a late model white Chrysler, 1963 Florida [REDACTED] which was occupied by an unknown individual.

- 4 - Bureau (RM)
 - (1 - 157-97)
- 2 - Atlanta (RM)
 - (1 - 105-942)
 - (1 - 157-582)
- 2 - Birmingham (RM)
 - (1 - 157-352)
 - (1 - 105-477)
- 2 - Miami (RM)
 - (1 - 157-876)

REC-114

EX-114

157-1025-6 [Handwritten initials]

REC 37 NOV 11 1963

COPY FILED IN 157-1025-6

XXXXXX
XXXXXX
XXXXXX

**FEDERAL BUREAU OF INVESTIGATION
FOIPA DELETED PAGE INFORMATION SHEET**

1

Page(s) withheld entirely at this location in the file. One or more of the following statements, where indicated, explain this deletion.

- Deleted under exemption(s) (b)(7)(C) and (D) with no segregable material available for release to you.
- Information pertained only to a third party with no reference to you or the subject of your request.
- Information pertained only to a third party. Your name is listed in the title only.
- Documents originated with another Government agency(ies). These documents were referred to that agency(ies) for review and direct response to you.

_____ Pages contain information furnished by another Government agency(ies). You will be advised by the FBI as to the releasability of this information following our consultation with the other agency(ies).

_____ Page(s) withheld for the following reason(s):

For your information: _____

The following number is to be used for reference regarding these pages:
157-1025-625 p2

XXXXXX
XXXXXX
XXXXXX

XXXXXXXXXXXXXXXXXXXXX
X DELETED PAGE(S) X
X NO DUPLICATION FEE X
X FOR THIS PAGE X
XXXXXXXXXXXXXXXXXXXXX

JK 157-584

[REDACTED]

[REDACTED]

[REDACTED]

[REDACTED]

[REDACTED]

[REDACTED]

[REDACTED]

[REDACTED]

[REDACTED]

[REDACTED]

[REDACTED]

b7c
b7d

It is noted that the Florida Times Union Newspaper, Jacksonville, Florida, dated 11/6/63, revealed that four Jacksonville Ku Klux Klansmen were cleared of assault and battery charges on 11/5/63 in St. Augustine in connection with the beating of four Negroes, who ventured into the vicinity of a

JK 157-584

Klan rally. According to the article, one klansman was found innocent and cases against the other three klansmen were dismissed since the victims were unable to identify the klansmen as their assailants. This news clipping has been forwarded to the Bureau separately.

FEDERAL BUREAU OF INVESTIGATION

REPORTING OFFICE NEW ORLEANS	OFFICE OF ORIGIN BIRMINGHAM	DATE 11/15/63	INVESTIGATIVE PERIOD 10/22 - 11/7/63
TITLE OF CASE UNSUBS; Bombing of 16th Street Baptist Church, Birmingham, Alabama, 9/15/63		REPORT MADE BY SA [REDACTED]	TYPED BY lyc
		CHARACTER OF CASE BOMBING MATTERS <i>LDC</i>	

REFERENCES

Report of SA [REDACTED] dated 10/22/63 at New Orleans.
 Telephone call from [REDACTED] Birmingham, to SAC H. G. MAYNOR at New Orleans, 10/22/63.
 Philadelphia airtel to Bureau, 10/19/63.
 New Orleans airtel to Birmingham, 10/24/63.

LEADS

NEW ORLEANS

AT NEW ORLEANS, LA. 1. Will report results of investigation presently being conducted at Lafayette, La. in regards to [REDACTED] (Philadelphia airtel to Bureau, 10/19/63).

APPROVED <i>AKQ</i>	SPECIAL AGENT IN CHARGE	DO NOT WRITE IN SPACES BELOW	
COPIES MADE: 5-Bureau (157-1025) 2-Birmingham (157-352) 2-New Orleans (157-1294)		157-1025-611 REC-3	
<i>rec'd Dept</i>		NOV 18 1963	
DISSEMINATION RECORD OF ATTACHED REPORT		NOTATIONS	
AGENCY <i>Crim Div</i>	REQUEST RECD. <i>6/26/64</i>	<i>MD</i>	
<i>6-7-64 B. bet did</i>		<i>General</i>	

NO 157-1294

2. Will continue contacts with informants, sources and law enforcement agencies for identities of possible suspects.

ADMINISTRATIVE

Information contained in the details of this report setting forth results of investigation conducted in the New Orleans Division has previously been furnished to Birmingham by referenced New Orleans airtel to Birmingham.

To date no pertinent information regarding possible suspects has been received from informants, sources or law enforcement agencies. Identities of individuals contacted are not being set forth but are being retained in the New Orleans file in this matter.

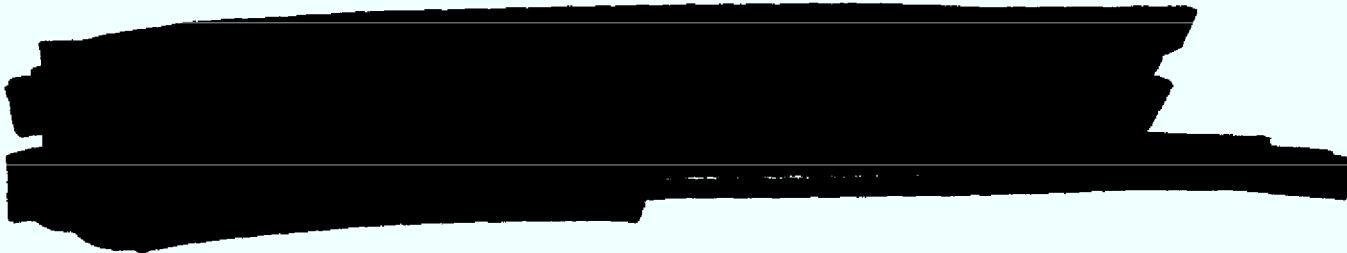
b7c, d

B*

COVER PAGE

UNITED STATES DEPARTMENT OF JUSTICE
FEDERAL BUREAU OF INVESTIGATION

Copy to: *67c*

Report of: SA [redacted] Office: NEW ORLEANS
Date: 11/15/63

Field Office File No.: 157-1294 Bureau File No.: 157-1025

Title: UNKNOWN SUBJECTS;
Bombing of 16th Street Baptist Church
Birmingham, Alabama
September 15, 1963

Character: BOMBING MATTERS

67c 15
Synopsis:

[Large redacted block]

Three other Negro boys mentioned as having gone to Birmingham located and denied ever having been to Birmingham. Investigation in area of pay telephone from where call placed in Baton Rouge unproductive.

P

DETAILS: AT NEW ORLEANS, LOUISIANA *67c*

On October 22, 1963 [redacted] of the Birmingham Division, telephonically contacted the New Orleans Office and advised SAC H. G. MAYNOR of the following information:

XXXXXX
XXXXXX
XXXXXX

**FEDERAL BUREAU OF INVESTIGATION
FOIPA DELETED PAGE INFORMATION SHEET**

12 Page(s) withheld entirely at this location in the file. One or more of the following statements, where indicated, explain this deletion.

- Deleted under exemption(s) (b)(7)(C) and (D) with no segregable material available for release to you.
- Information pertained only to a third party with no reference to you or the subject of your request.
- Information pertained only to a third party. Your name is listed in the title only.
- Documents originated with another Government agency(ies). These documents were referred to that agency(ies) for review and direct response to you.

_____ Pages contain information furnished by another Government agency(ies). You will be advised by the FBI as to the releasability of this information following our consultation with the other agency(ies).

_____ Page(s) withheld for the following reason(s):

For your information: _____

The following number is to be used for reference regarding these pages:
157-1025-676 p 2-13

XXXXXX
XXXXXX
XXXXXX

XXXXXXXXXXXXXXXXXXXXX
X DELETED PAGE(S) X
X NO DUPLICATION FEE X
X FOR THIS PAGE X
XXXXXXXXXXXXXXXXXXXXX

UNITED STATES GOVERNMENT

Memorandum

Tolson	_____
Belmont	_____
Mohr	_____
Casper	_____
Callahan	_____
Conrad	_____
DeLoach	_____
Evans	_____
Gale	_____
Rosen	_____
Sullivan	_____
Tavel	_____
Trotter	_____
Tele. Room	_____
Holmes	_____
Gandy	_____

TO : Mr. Belmont *AB*

DATE: November 27, 1963

FROM : A. Rosen *BR*

SUBJECT: UNKNOWN SUBJECTS;
BOMBING OF SIXTEENTH
STREET BAPTIST CHURCH
BIRMINGHAM, ALABAMA
SEPTEMBER 15, 1963
BOMBING MATTERS

2 Copies made by *CS*
 for review by Rowe Task Force
 Date 1-8-79

In view of the results which have been obtained in developing 

 a campaign of concentrated endeavor is being pursued to "turn" other associates of prime suspects to develop them as informants. In connection with this program, every former associate of prime suspects in the Eastview and Bessemer Klaverns in the Birmingham territory is being contacted and interviewed with the thought of obtaining information concerning the prime or secondary suspects. These interviews continued on 11-26-63 with no pertinent information being obtained.



- 1 - Mr. Mohr
- 1 - Mr. DeLoach
- 1 - Mr. Evans

HET:cac
 (9)

REC-50

157-41025-677
 6-11-63
 4 DEC 2 1963

file
67C1A
67C1A

Memorandum to Mr. Belmont
RE: UNKNOWN SUBJECTS; BOMBING OF
SIXTEENTH STREET BAPTIST CHURCH

62-10

ACTION

You will be kept advised of developments.

V
Q
R
970

UNITED STATES GOVERNMENT

Memorandum

TO : DIRECTOR, FBI (157-1025) DATE: 11/19/63
 ATTENTION: IDENTIFICATION DIVISION
 LATENT FINGERPRINT SECTION
 FROM: SAC, BIRMINGHAM (157-352)(P)
 SUBJECT: BAPBOMB

The Latent Fingerprint Section is requested to compare fingerprints of [redacted] with latents from attempted bombing of Temple Beth-El, Birmingham, Alabama, 1958.

- ③ - Bureau *b7c*
- 3 - Birmingham
- (1 - 157-493)

(6)

11-26-63
11-26-63
11-26-63

EX-100-1000

REC-50

157-1025-691

NOV 22 1963

[Handwritten signatures and initials]

FEDERAL BUREAU OF INVESTIGATION

Washington, D. C. 20537



REPORT

of the

LATENT FINGERPRINT SECTION

Identification Division

YOUR FILE NO. **157-352**
FBI FILE NO. **157-1025 - 678**
LATENT CASE NO. **45563**

November 27, 1963

TO: **REC-50 SAC, Birmingham**

RE: **BAPBOMB;**

REFERENCE: **Letter 11/13/63**
EXAMINATION REQUESTED BY: **Birmingham**
SPECIMENS:

The latent fingerprints in the case entitled "Unknown Subject; Attempted Bombing of Temple Beth-El Jewish Synagogue, 21st Way and Highland Avenue, Birmingham, Alabama, 4/29/53," are not identical with the fingerprints of [REDACTED]

1 - Bufile (100-135-4)

JEB:jpl JPL
(5)

NOV 27 10 30 AM '63
FBI
REC'D - CIV RIGHTS

NOV 27 1963
DEPT. OF JUSTICE

UNRECORDED COPY FILED IN

MAILED 11
NOV 27 1963
COMM-FBI

- Tolson _____
- Belmont _____
- Mohr _____
- Casper _____
- Callahan _____
- Conrad _____
- DeLoach _____
- Evans _____
- Gale _____
- Rosen _____
- Sullivan _____
- Tavel _____
- Trotter _____
- Tele. Room _____
- Holmes _____
- Gandy _____

John Edgar Hoover
John Edgar Hoover, Director

THIS REPORT IS FURNISHED FOR OFFICIAL USE ONLY
MAIL ROOM TELETYPE UNIT

100-135-4

L2c

REC-50
NOV 27 1963

FEDERAL BUREAU OF INVESTIGATION
LATENT FINGERPRINT SECTION WORK SHEET

Recorded: 11-26-63/9:00AM

Reference No: 157-352

Received: 11-22-63/dab

FBI File No: 157-1025 - 67

Latent Case No: 45563

Answer to: SAC, BIRMINGHAM

Examination requested by: Addressee

Copy to:

RE: BAPBOMB

Date of reference communication: 11-19-63 letter.

Specimens:

Named suspect:

[Redacted Name]

LTC

Result of examination:

Examination by:

Burke

Evidence noted by:

[Handwritten signature]

*Assembly 11/26
Latent fpts in Beth-el case. not ident
fpts [Redacted] 11/26 100-135-4.
LTC*

Examination completed: 100 PM 11-26-63 Dictated: 11-26-63 *[Signature]*

FBI

Date: 11/20/63

Transmit the following in _____
(Type in plain text or code)

Via AIRTEL AIR MAIL
(Priority or Method of Mailing)

Mr. Tolson	_____
Mr. Belmont	_____
Mr. Mohr	_____
Mr. Casper	_____
Mr. Callahan	_____
Mr. Conrad	_____
Mr. Felt	_____
Mr. Evans	_____
Mr. Gale	_____
Mr. Rosen	_____
Mr. Sullivan	_____
Mr. Tavel	_____
Mr. Trotter	_____
Tele. Room	_____
Miss Holmes	_____
Miss Gandy	_____

TO: DIRECTOR, FBI
ATTENTION: ASSISTANT DIRECTOR ROSEN

FROM: SAC, BIRMINGHAM (157-352)

SUBJECT: BAPBOMB

Enclosed for the information of the Bureau are two copies of a clipping from "The Birmingham Post-Herald" on 11/20/63, captioned "FIELDS Sues News, Writer." This news article relates that Dr. EDWARD R. FIELDS of The National States Rights Party filed a libel suit for one million dollars in a State Court at Birmingham against "The Birmingham News" and DAVID LAWRENCE, Columnist, charging that LAWRENCE's column on 9/25/63 made libelous statements against FIELDS. LAWRENCE allegedly made Communist allegations against FIELDS.

McGowan

*1507 ALBIS AVE
BIRMINGHAM
ALABAMA*

ALA

3 Bureau (Enc 2)
2 Birmingham
[Redacted]
(5)

ENCLOSURE

*220
rec Dept*

REC-26

157-1025-679

11 NOV 22 1963

NOV 22 1963

SEARCHED
SERIALIZED
INDEXED
FILED

Approved: *[Signature]*
Special Agent in Charge

Sent _____ M Per _____

68 DEC 4

(Mount Clipping in Space Below)

Fields Sues News, Writer

A suit seeking \$1 million from the Birmingham News and from syndicated columnist David Lawrence for libel was filed in Circuit Court here yesterday by Edward R. Fields, head of the National States Rights Party.

The action, filed in Field's behalf by Atty. Matt Murphy, seeks \$500,000 damages for each of two counts which are based on a Lawrence column which appeared in the News Sept. 25.

The statements, the suit contends, in effect charged the plaintiff "with the crime of being a party with an international revolutionary Communist conspiracy which is committed to overthrow by force and violence the government of the United States and several states, including Alabama.

It further alleges that the article charged or intimated Fields "was a member of the Communist Party" whose objective and purpose is to "overthrow the Federal or state government by force and violence, and that he "knowingly participated in the revolutionary activities of the Communist party knowing the revolutionary object or purposes thereof."

The suit seeks both punitive and compensatory damages on each of the counts and asks for a jury trial.

Fields' address was listed as 1507 Mims-av.

Count one of the suit cited the following passage from the article, as having been published with "intent to defame" the plaintiff:

"FROM WHERE? Where does the money come from to finance such a mischief-making organization? The time would seem to be ripe for the House Committee on Un-American Activities to subpoena records and ascertain whether any foreign funds have been coming to the Birmingham group.

"Again and again, in different parts of the world—especially in Latin America—groups that seem to be still espousing the Hitler-Nazi doctrines are found to have close links with Communist agents. What more natural way for the Communists to stir up trouble and friction!"

Cited as basis for the damages in court two, was the following quotation from the newspaper article:

"A Federal grand jury has just indicted some of the members of this so-called states' rights group — all of them white — for alleged conspiracy to interfere with a court order and some for allegedly obstructing by violence, the process of law enforcement in desegregating public schools.

"Two white boys — arrested and charged with shooting a 13-year-old Negro boy a few hours after a Negro church was bombed on Sept. 15 in Birmingham—had just attended an impassioned rally held by the 'states' rights group."

(Indicate page, name of newspaper, city and state.)

THE BIRMINGHAM NEWS

14 THE BIRMINGHAM POST-HERALD

BIRMINGHAM, ALABAMA

Date: 11/20/63
Edition: FINAL
Author:
Editor: JAMES E. MILLS
Title: BAPBOMB

Character: BM
or
Classification:
Submitting Office: BIRMINGHAM

Being Investigated

157-1025-679
ENCLOSURE

FBI

Date: 11/23/63

Transmit the following in _____
(Type in plain text or code)

Via AIRTEL AIR MAIL
(Priority or Method of Mailing)

Mr. Tolson	_____
Mr. Belmont	_____
Mr. Mohr	_____
Mr. Casper	_____
Mr. Callahan	_____
Mr. Conrad	_____
Mr. DeLoach	_____
Mr. Evans	_____
Mr. Gale	_____
Mr. Rosen	_____
Mr. Sullivan	_____
Mr. Tavel	_____
Mr. Trotter	_____
Tele. Room	_____
Miss Holmes	_____
Miss Gandy	_____

TO: DIRECTOR, FBI (157-1025)
 ATTENTION: ASSISTANT DIRECTOR ROSEN

FROM: SAC, BIRMINGHAM (157-352)

SUBJECT: BAPBOMB

Assistant Director ROSEN, on 11/22/63, granted Bureau authority to SAC ROY K. MOORE for the use of the polygraph in interviewing [redacted] and [redacted] was interviewed by SA [redacted] with the aid of the polygraph.

[Large redacted block]

[Large redacted block]

- 3- Bureau
- 1- Little Rock (Info) (94-220A)
- 3- Birmingham (2- 157-352) (1- 94-219)

REC 27 157-1025-680

14 NOV 26 1963

58 DEC 6 1963

Approved: _____
Special Agent in Charge

Sent _____ M Per _____

SD

BH 157-352

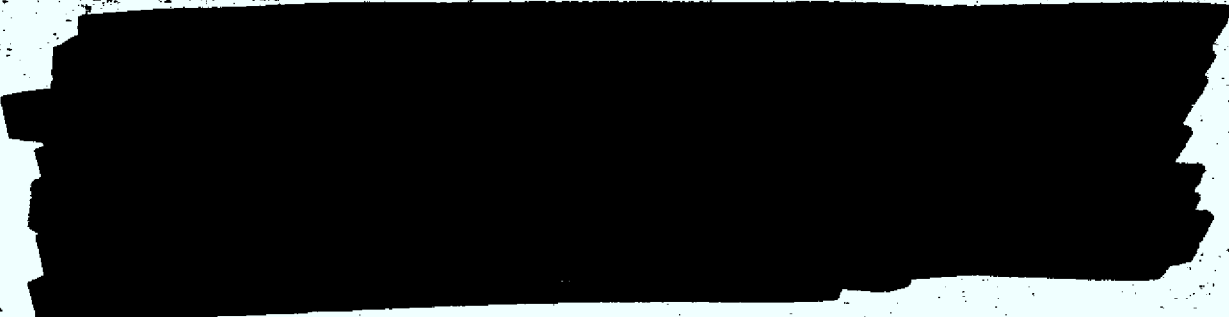

The polygraph chart, listed questions and polygraph consent form signed by [redacted] are being retained in the Birmingham file.

A copy of this airtel is designated for Little Rock inasmuch as the polygraph examiner is assigned to that office.

F B I

Date: 11/21/63

Transmit the following in _____
(Type in plain text or code)

Via AIRTEL AIR MAIL
(Priority or Method of Mailing)

TO: DIRECTOR, FBI
ATTENTION: FBI LABORATORY
PERSONAL ATTENTION: ASSISTANT DIRECTOR ROSEN

FROM: SAC, BIRMINGHAM (157-352)(P)

SUBJECT: BAPBOMB

POLYGRAPH MATTERS
Bufile 80-5-4

Bureau authority for polygraph interviews of _____ was given by Assistant Director ROSEN in telephone conversation with SAC ROY K. MOORE on 11/18/63.

[REDACTED]

- ③ - Bureau (AM)
- 1 - Little Rock (94-220A)(Info)(AM)
- 6 - Birmingham
 - (1 - 94-219)
 - (1 - 157-398)
 - (1 - 157-400)
 - (1 - 157-567)

REC 27 157-1025-681

11 NOV 20 1963

Approved: _____ Sent _____ M Per _____
Special Agent in Charge

6210

100000 1205
[REDACTED] 24
(10)

XXXXXX
XXXXXX
XXXXXX

**FEDERAL BUREAU OF INVESTIGATION
FOIPA DELETED PAGE INFORMATION SHEET**

1 Page(s) withheld entirely at this location in the file. One or more of the following statements, where indicated, explain this deletion.

- Deleted under exemption(s) (b)(7)(C), (D) and (E) with no segregable material available for release to you.
- Information pertained only to a third party with no reference to you or the subject of your request.
- Information pertained only to a third party. Your name is listed in the title only.
- Documents originated with another Government agency(ies). These documents were referred to that agency(ies) for review and direct response to you.

_____ Pages contain information furnished by another Government agency(ies). You will be advised by the FBI as to the releasability of this information following our consultation with the other agency(ies).

_____ Page(s) withheld for the following reason(s):

For your information: _____

The following number is to be used for reference regarding these pages:
157-1025-681 p2

XXXXXX
XXXXXX
XXXXXX

XXXXXXXXXXXXXXXXXXXXX
X DELETED PAGE(S) X
X NO DUPLICATION FEE X
X FOR THIS PAGE X
XXXXXXXXXXXXXXXXXXXXX

XXXXXX
XXXXXX
XXXXXX

FEDERAL BUREAU OF INVESTIGATION FOIPA DELETED PAGE INFORMATION SHEET

2

Page(s) withheld entirely at this location in the file. One or more of the following statements, where indicated, explain this deletion.

Deleted under exemption(s) (b)(7)(C) with no segregable material available for release to you.

Information pertained only to a third party with no reference to you or the subject of your request.

Information pertained only to a third party. Your name is listed in the title only.

Documents originated with another Government agency(ies). These documents were referred to that agency(ies) for review and direct response to you.

_____ Pages contain information furnished by another Government agency(ies). You will be advised by the FBI as to the releasability of this information following our consultation with the other agency(ies).

_____ Page(s) withheld for the following reason(s):

For your information: _____

The following number is to be used for reference regarding these pages:

157-1025-682

XXXXXX
XXXXXX
XXXXXX

XXXXXXXXXXXXXXXXXXXXX
X DELETED PAGE(S) X
X NO DUPLICATION FEE X
X FOR THIS PAGE X
XXXXXXXXXXXXXXXXXXXXX

FBI

Date: 11/26/63

Transmit the following in _____
(Type in plain text or code)

Via AIRTEL AIRMAIL
(Priority or Method of Mailing)

TO: DIRECTOR, FBI (157-1025)
FROM: SAC, KNOXVILLE (157-189) (P)

BAPBOMB

Re Atlanta teletype to Bureau, Birmingham and Knoxville, November 22, 1963.

Re Bureau and Atlanta files entitled [redacted] RACIAL MATTERS, Bufile 157-97, Atlanta file 105-942, and case entitled CHRISTIAN ANTI-JEWISH PARTY, Bufile 65-15743, Atlanta file 100-4976.

Previous communications in referenced files have listed known relatives of [redacted] as residing in Chattanooga Valley section near Chattanooga, Tennessee, but in Walker County, Georgia. There are no known relatives of [redacted] residing in Chattanooga, Tennessee, or in the State of Tennessee.

Atlanta should therefore arrange coverage they desire re [redacted] on Thanksgiving Day. Knoxville will alert sources of information for any information re [redacted] activities Thanksgiving Day but unless Atlanta has specific information re relatives of [redacted] in Chattanooga, no coverage being arranged re his relatives since all known relatives reside in the State of Georgia.

- 3 - Bureau (Registered Mail)
- 2 - Birmingham (157-353) (Registered Mail)
- 2 - Atlanta (157-582) (Registered Mail)
- 2 - Knoxville

3 NOV 29 1963

Approved: _____ Sent _____ M Per _____

68 DEC 4 Special Agent in Charge

7)

b7c

C.C. Wick

REC-52

157-1025-682

[Handwritten signature]

Date of Mail 11-15-63

Has been removed and placed in the Special File Room of Records Branch.

See File 66-2554-7530 for authority.

Subject

JUNE MAIL

Bapboub

200
Date 1-8-79
CT

Removed By

65 DEC 9 1963

File Number

157-1025-684

XXXXXX
XXXXXX
XXXXXX

FEDERAL BUREAU OF INVESTIGATION
FOIPA DELETED PAGE INFORMATION SHEET

4 Page(s) withheld entirely at this location in the file. One or more of the following statements, where indicated, explain this deletion.

Deleted under exemption(s) (b)(2) (b)(7)(C) and (D) with no segregable material available for release to you.

Information pertained only to a third party with no reference to you or the subject of your request.

Information pertained only to a third party. Your name is listed in the title only.

Documents originated with another Government agency(ies). These documents were referred to that agency(ies) for review and direct response to you.

_____ Pages contain information furnished by another Government agency(ies). You will be advised by the FBI as to the releasability of this information following our consultation with the other agency(ies).

_____ Page(s) withheld for the following reason(s):

For your information: _____

The following number is to be used for reference regarding these pages:
157-1025-684

XXXXXX
XXXXXX
XXXXXX

XXXXXXXXXXXXXXXXXXXXX
X DELETED PAGE(S) X
X NO DUPLICATION FEE X
X FOR THIS PAGE X
XXXXXXXXXXXXXXXXXXXXX

Date of Mail 11-15-63

Has been removed and placed in the Special File Room of Records Branch.

See File 66-2554-7530 for authority.

2 Copies made by *CS*
for review by Rowe Task Force
Date 1-8-79

Subject JUNE MAIL *Bapboubi*

Removed By *66 DEOS 1968*

File Number *157-1025-685*

XXXXXX
XXXXXX
XXXXXX

FEDERAL BUREAU OF INVESTIGATION FOIPA DELETED PAGE INFORMATION SHEET

4 Page(s) withheld entirely at this location in the file. One or more of the following statements, where indicated, explain this deletion.

Deleted under exemption(s) (b)(2), b7C, D with no segregable material available for release to you.

Information pertained only to a third party with no reference to you or the subject of your request.

Information pertained only to a third party. Your name is listed in the title only.

Documents originated with another Government agency(ies). These documents were referred to that agency(ies) for review and direct response to you.

_____ Pages contain information furnished by another Government agency(ies). You will be advised by the FBI as to the releasability of this information following our consultation with the other agency(ies).

_____ Page(s) withheld for the following reason(s):

For your information: _____

The following number is to be used for reference regarding these pages:
157-1025-685

XXXXXX
XXXXXX
XXXXXX

XXXXXXXXXXXXXXXXXXXXX
X DELETED PAGE(S) X
X NO DUPLICATION FEE X
X FOR THIS PAGE X
XXXXXXXXXXXXXXXXXXXXX

FBI

Date: 11/20/63

Transmit the following in _____
(Type in plain text or code)

Via AIRTEL AIRMAIL
(Priority or Method of Mailing)

TO: DIRECTOR, FBI (88-22518)
ATTN: CIVIL RIGHTS SECTION, GENERAL INVESTIGATIVE DIVISION
FROM: SAC, JACKSONVILLE (88-1943) (RUC)
SUBJECT: [REDACTED] b7c
UFAT - STATE BOMBING MATTERS
(OO: MIAMI) BAPBOMB

Re Miami airtel to Bureau, 11/7/63;
Birmingham airtel to Bureau, 11/9/63, and Birmingham airtel
to Bureau, 11/13/63.

A review of the Jacksonville files regarding the
subject disclosed no evidence that he has ever resided or
has recently traveled in the Jacksonville division.

- ② - Bureau (1 - 157-1025)
- 2 - Atlanta (88-3205)
(1 - 157-BAPBOMB)
- 3 - Birmingham (88-3205)
(1 - 157-BAPBOMB)
- 2 - Charlotte (88-5374)
(1 - 157-BAPBOMB)
- 2 - Mobile (88-4164)
(1 - 157-BAPBOMB)
- 2 - Savannah (1 - 157-BAPBOMB)
- 2 - Tampa (88-1581)
(1 - 157-BAPBOMB)
- 4 - Miami (88-5066)
(1 - 157-97)
(1 - 157-643)
(1 - 157-BAPBOMB)
- 2 - Jacksonville (1 - 157-BAPBOMB)

157-1025-

DEC 6 1963

[REDACTED] b7c
58 DEC 6 1963

88-22518-11
ORIGINAL FILED IN

JK 88-1943

The subject is being considered as a possible suspect in the recent dynamiting occurring on property of the Florida East Coast Railroad and photographs of the subject have been furnished to Agents conducting investigation in that case.

There are no unsolved bombings involving racial matters in the Jacksonville Division and the photographs obtained from the subject's camera at the time of arrest could not be identified with the dynamiting of the FECRR property.

With reference to the Florida Vehicle Registration (1959) for a [REDACTED]

[REDACTED] the following information was developed by the Jacksonville Office and furnished to the Miami Office by Jacksonville airtel dated 9/12/63.

THE SUBJECT IS A POTENTIAL BOMBING SUSPECT OF THE MIAMI OFFICE AND SHOULD BE CONSIDERED DANGEROUS.

UNITED STATES GOVERNMENT

Memorandum

TO : Mr. Belmont

DATE: December 3, 1963

FROM : A. Rosen *Rosen*

SUBJECT: UNKNOWN SUBJECTS;
BOMBING OF SIXTEENTH
STREET BAPTIST CHURCH
BIRMINGHAM, ALABAMA
SEPTEMBER 15, 1963
BOMBING MATTERS

Tolson	<input checked="" type="checkbox"/>
Belmont	<input checked="" type="checkbox"/>
Mohr	<input type="checkbox"/>
Casper	<input checked="" type="checkbox"/>
Callahan	<input checked="" type="checkbox"/>
Conrad	<input type="checkbox"/>
DeLoach	<input checked="" type="checkbox"/>
Evans	<input type="checkbox"/>
Gale	<input checked="" type="checkbox"/>
Rosen	<input checked="" type="checkbox"/>
Sullivan	<input type="checkbox"/>
Tavel	<input type="checkbox"/>
Trotter	<input type="checkbox"/>
Tele. Room	<input type="checkbox"/>
Holmes	<input type="checkbox"/>
Gandy	<input type="checkbox"/>

Assistant United States Attorney R. Macey Taylor, Birmingham, has had the charges brought against Special Agents [redacted] and [redacted] by the members of the National States Rights Party (NSRP) removed to Federal Court from City Recorder's Court.

The charges brought by Edward R. Fields, leader of the NSRP, charge our Agents with trespass and disorderly conduct growing out of their interview of NSRP members at the headquarters of the NSRP.

[Large redacted block]

[Redacted block]

[Redacted block]

- 1 - Mr. Mohr
- 1 - Mr. DeLoach
- 1 - Mr. Evans

RBL:pab *ak*
(9)

REC-44

157-1025-686

6-11
PERS. REC. UNIT

hee

Memorandum to Mr. Belmont
RE: BOMBING OF SIXTEENTH STREET
BAPTIST CHURCH

Contact with informants and sources on 12/2/63 has revealed miscellaneous information concerning the principal suspects in the bombing cases but no additional pertinent information was furnished.

ACTION:

You will be kept advised of developments.

Q *R* *dis/...* *RM*

XXXXXX
XXXXXX
XXXXXX

FEDERAL BUREAU OF INVESTIGATION FOIPA DELETED PAGE INFORMATION SHEET

1 Page(s) withheld entirely at this location in the file. One or more of the following statements, where indicated, explain this deletion.

- Deleted under exemption(s) (L)(G)(C) and (D) with no segregable material available for release to you.
- Information pertained only to a third party with no reference to you or the subject of your request.
- Information pertained only to a third party. Your name is listed in the title only.
- Documents originated with another Government agency(ies). These documents were referred to that agency(ies) for review and direct response to you.

_____ Pages contain information furnished by another Government agency(ies). You will be advised by the FBI as to the releasability of this information following our consultation with the other agency(ies).

_____ Page(s) withheld for the following reason(s):

For your information: _____

The following number is to be used for reference regarding these pages:
157-1025-687 p 2

XXXXXX
XXXXXX
XXXXXX

XXXXXXXXXXXXXXXXXXXXX
X DELETED PAGE(S) X
X NO DUPLICATION FEE X
X FOR THIS PAGE X
XXXXXXXXXXXXXXXXXXXXX

PAGE THREE

[REDACTED]

b7c
10

THIRTY FOUR INTERVIEWS CONDUCTED TODAY. CONTEMPLATED SEVENTYTWO.

END AND ACK

WA 9-55 PM OK FBI WA RL

TU CLR

FBI

Date: 11/28/63

Mr. Tolson	_____
Mr. Belmont	_____
Mr. Mohr	_____
Mr. Casper	_____
Mr. Callahan	_____
Mr. Conrad	_____
Mr. DeLoach	_____
Mr. Evans	_____
Mr. Gale	_____
Mr. Rosen	_____
Mr. Sullivan	_____
Mr. Tavel	_____
Mr. Trotter	_____
Tele. Room	_____
Miss Holmes	_____
Miss Gandy	_____

Transmit the following in _____
(Type in plain text or code)

Via AIRTEL AIR MAIL
(Priority or Method of Mailing)

TO: DIRECTOR, FBI
ATTENTION: FBI LABORATORY
PERSONAL ATTENTION: ASSISTANT DIRECTOR ROSEN

FROM: SAC, BIRMINGHAM (157-352)

SUBJECT: BAPBOMB

POLYGRAPH MATTERS
Bufile 80-5-4

Handwritten signature
EB

Bureau authority was granted by Assistant Director ROSEN on 11/27/63 for the interview of [REDACTED] with the aid of the polygraph. The polygraph examination was conducted by SA [REDACTED] at Birmingham on 11/27/63. The polygraph consent form, polygraph chart, and list of questions are being retained in the Birmingham file.

[REDACTED]

- ③ - Bureau (AM)
- 1 - Little Rock (94-220A) (Info) (AM)
- 3 - Birmingham
(2 - 157-352)
(1 - 94-219)

157-1025-6285
Handwritten notes and initials

REC-31

Approved: _____

Special Agent in Charge

Sent _____

M

Per _____

Vertical handwritten note on left margin

62014
BH 157-352



A copy of this airtel is designated for Little Rock inasmuch as the polygraph examiner is assigned to that office.

XXXXXX
XXXXXX
XXXXXX

**FEDERAL BUREAU OF INVESTIGATION
FOIPA DELETED PAGE INFORMATION SHEET**

4 Page(s) withheld entirely at this location in the file. One or more of the following statements, where indicated, explain this deletion.

Deleted under exemption(s) (b)(7)(C) and (D) with no segregable material available for release to you.

Information pertained only to a third party with no reference to you or the subject of your request.

Information pertained only to a third party. Your name is listed in the title only.

Documents originated with another Government agency(ies). These documents were referred to that agency(ies) for review and direct response to you.

_____ Pages contain information furnished by another Government agency(ies). You will be advised by the FBI as to the releasability of this information following our consultation with the other agency(ies).

_____ Page(s) withheld for the following reason(s):

For your information: _____

The following number is to be used for reference regarding these pages:
157-1025-689

XXXXXX
XXXXXX
XXXXXX

XXXXXXXXXXXXXXXXXXXXX
X DELETED PAGE(S) X
X NO DUPLICATION FEE X
X FOR THIS PAGE X
XXXXXXXXXXXXXXXXXXXXX

PAGE TWO

67-10

[REDACTED]

ADDITIONAL MEMBERS OF EASTVIEW AND BESSEMER KLAVERNS INTERVIEWED TODAY HOWEVER, NOTHING OF SIGNIFICANCE DEVELOPED.

FORTYTWO INTERVIEWS TODAY. ONE HUNDRED SEVENTYFOUR PENDING.

END AND ACK PLS.

10-51 PM OK FBI WA RL

TU CLEAR

0

REC-5
OCT 21 1951

NA
11/24
[Handwritten initials]

FEDERAL BUREAU OF INVESTIGATION
U. S. DEPARTMENT OF JUSTICE
COMMUNICATIONS SECTION

NOV 24 1963

TELETYPE

Mr. Tolson	_____
Mr. Belmont	_____
Mr. Mohr	_____
Mr. Casper	_____
Mr. Callahan	_____
Mr. Conrad	_____
Mr. DeLoach	_____
Mr. Evans	_____
Mr. Gale	_____
Mr. Rosen	_____
Mr. Sullivan	_____
Mr. Tavel	_____
Mr. Trotter	_____
Tele. Room	_____
Miss Holmes	_____
Miss Gandy	_____

[Handwritten signature/initials over routing slip]

URGENT 11-24-63 8-30 PM CST HEP

TO DIRECTOR

FROM SAC BIRMINGHAM /157-352/ 2P

① BAPBOMB, ET AL, DAILY SUMMARY.

[Handwritten signature]

1

[Large redacted area consisting of multiple thick black horizontal bars covering the main body of the teletype message.]

END PAGE ONE

11/24
11-24-63
[Handwritten notes and signatures]

157-1025-2091

4 DEC 3 1963

[Handwritten signature]

PAGE TWO.

[REDACTED]

FND QUOTE.
~~END~~

[REDACTED]

SPOT SURVEILLANCES AND INTERVIEWS WITH THE ASSOCIATES OF PRIME SUSPECTS CONTINUES. NO ADDITIONAL INFORMATION OF SIGNIFICANCE DEVELOPED DURING PAST TWENTY FOUR HOURS.

ADDITIONAL INTERVIEWS WITH KLAN ASSOCIATES OF PRIME SUSPECTS PLANNED.

INTERVIEWS CONDUCTED TODAY TWENTYONE. ONE HUNDRED SEVENTYEIGHT INTERVIEWS PENDING.

END

9-36 PM OK FBI WA NH

TU O

WASH DC
FBI
SEP 21 1956

FEDERAL BUREAU OF INVESTIGATION
U. S. DEPARTMENT OF JUSTICE
COMMUNICATIONS SECTION

NOV 26 1963

TELETYPE

Mr. Tolson	_____
Mr. Belmont	_____
Mr. Mohr	_____
Mr. Casper	_____
Mr. Callahan	_____
Mr. Conrad	_____
Mr. DeLoach	_____
Mr. Evans	_____
Mr. Gale	_____
Mr. Rosen	_____
Mr. Sullivan	_____
Mr. Tavel	_____
Mr. Trotter	_____
Tele. Room	_____
Miss Holmes	_____
Miss Gandy	_____

URGENT 11-26-63 9-34 PM CST WCR
 TO DIRECTOR /157-1025/
 FROM SAC, BIRMINGHAM /157-352/ 1P
 BAPBOMB. ET AL.

DAILY SUMMARY.

SEVERAL MEMBERS OF BESSEMER AND EASTVIEW KLAVERSN, UNITED KLANS OF AMERICA, INC., KU KLUX KLAN, INTERVIEWED TODAY TO NO AVAIL. INFORMERS, SOURCES, AND CONTACTS OF PRIME SUSPECTS COULD FURNISH NO NEW INFORMATION.

EFFORTS BEING MADE TO DEVELOP ADDITIONAL INFORMERS IN ACTIVE KLAVERNS AS WELL AS THOSE WHO MAY BE ACQUAINTED WITH OR CAN GAIN CONFIDENCE OF PRIME SUSPECTS.

THIRTYSEVEN INTERVIEWS TODAY. ONE HUNDRED NINETEEN PENDING.

12 DEC 3 1963

10-38 PM OK FBI WA MSL

Jan 11 1964
15 NOV

*Rec'd
 11/27/63
 BACK AND HOLD*

EX-108

REC-26
 11/27/63
 157-1025-692
 67th

PAGE TWO.

[REDACTED]

67210

FORTYONE INTERVIEWS CONDUCTED TODAY. ONE HUNDRED TWENTYFIVE PENDING.

END,

10-28 PM OK BXX FBI WA MSL

TU CLR

NOV 28 1953

NA 11/28/63
m

FEDERAL BUREAU OF INVESTIGATION
U.S. DEPARTMENT OF JUSTICE
COMMUNICATIONS SECTION

NOV 28 1963

TELETYPE

Mr. Tolson	_____
Mr. Belmont	_____
Mr. Mohr	_____
Mr. Casper	_____
Mr. Callahan	_____
Mr. Conrad	_____
Mr. DeLoach	_____
Mr. Evans	_____
Mr. Gale	_____
Mr. Rosen	_____
Mr. Sullivan	_____
Mr. Tavel	_____
Mr. Trotter	_____
Tele. Room	_____
Miss Holmes	_____
Miss Gandy	_____

URGENT 11-28-63 8-53 PM KTF

TO DIRECTOR /157-1025/

FROM SAC, BIRMINGHAM /157-352/

BAPBOMB

DAILY SUMMARY

ALL PRINCIPAL SUSPECTS CAPTIONED MATTER PHYSICALLY
CHECKED TODAY. ADDITIONAL MEMBERS BESSEMER AND EASTVIEW
KLAVERNS, KKK, INTERVIEWED. NO ADDITIONAL INFO DEVELOPED.
INTERVIEWS TODAY TWENTYONE. PENDING INTERVIEWS ONE HUNDRED
FIVE.

END AND ACK PLS.

9-56 PM OK FBI WA LLD

TU DISC

61523 724

REC-13

Rosen & Belmont 11/29/63
157-1025-694
FBI

12 DEC 3 1963

6-ML

FEDERAL BUREAU OF INVESTIGATION
DEPARTMENT OF JUSTICE
COMMUNICATIONS SECTION

NOV 30 1963

TELETYPE

Mr. Tolson	_____
Mr. DeLoach	_____
Mr. Mohr	_____
Mr. Bishop	_____
Mr. Casper	_____
Mr. Callahan	_____
Mr. Conrad	_____
Mr. Felt	_____
Mr. Gale	_____
Mr. Rosen	_____
Mr. Sullivan	_____
Mr. Tavel	_____
Mr. Trotter	_____
Tele. Room	_____
Miss Holmes	_____
Miss Gandy	_____

URGENT 11-30-63 8-06 PM CST HEP
TO DIRECTOR /157-1025/
FROM SAC BIRMINGHAM /157-352/ 1P

BAPBOMB

DAILY SUMMARY.

SPOT SURVEILLANCES MAINTAINED TODAY OF SUSPECTS. NO POSITIVE RESULTS. TWENTYONE INDIVIDUALS INTERVIEWED INCLUDING RELATIVES OF SUSPECTS WITHOUT PERTINENT INFO BEING RECEIVED. PREPARATION OF ADDITIONAL REPORT CONTINUING TODAY. NINETY INTERVIEWS PENDING.

END

9-09 PM OK FBI WA LLD
01 DEC 0 1963

REC-13

157-1025-19

EX-108

5 DEC 3 1963

Rosen & Belmont
12/2/63 ROR CAG

6-RLC



FEDERAL BUREAU OF INVESTIGATION
U. S. DEPARTMENT OF JUSTICE
COMMUNICATIONS SECTION

NOV 29 1963

TELETYPE

Mr. Tolson	_____
Mr. Belmont	_____
Mr. Mohr	_____
Mr. Casper	_____
Mr. Callahan	_____
Mr. Conrad	_____
Mr. DeLoach	_____
Mr. Felt	_____
Mr. Gale	_____
Mr. Rosen	_____
Mr. Sullivan	_____
Mr. Tavel	_____
Mr. Trotter	_____
Tele. Room	_____
Miss Holmes	_____
Miss Gandy	_____

URGENT 11-29-63 8-16 PM CST HEP

TO DIRECTOR /157-1025/

FROM SAC BIRMINGHAM /157-352/ 1P

BAPBOMB ETAL.

DAILY SUMMARY.

ADDITIONAL MEMBERS EASTVIEW AND BESSEMER KLAVERNS AS WELL AS RELATIVES OF PRINCIPAL SUSPECTS INTERVIEWED THIS DATE TO NO AVAIL.

[REDACTED SECTION]

THIS WILL BE FOLLOWED.

ADDITIONAL REPORT WILL BE SUBMITTED THIS WEEKEND TO REACH THE BUREAU ON MONDAY.

TWENTYSEVEN INTERVIEWS CONDUCTED TODAY. NINETYONE PENDING.

END

9-18 PM OK FBI WA RM

TU CLR

REC-3 157-1025-696

12 DEC 3 1963

EX-108

[Handwritten signature]

01 DEC 3 1963

[Handwritten notes: Dan Williams, 11/30/63]

1/1/63
8
12/1/63

FEDERAL BUREAU OF INVESTIGATION
U.S. DEPARTMENT OF JUSTICE
COMMUNICATIONS SECTION

DEC 1 1963 *RE*

TELETYPE

Mr. Tolson	_____
Mr. Belmont	_____
Mr. Mohr	_____
Mr. Casper	_____
Mr. Callahan	_____
Mr. Conrad	_____
Mr. DeLoach	_____
Mr. Evans	_____
Mr. Gale	_____
Mr. Rosen	_____
Mr. Sullivan	_____
Mr. Tavel	_____
Mr. Trotter	_____
Tele. Room	_____
Miss Holmes	_____
Miss Gandy	_____

URGENT 12-1-63 7-06 PM CST HEP
TO DIRECTOR /157-1025/
FROM SAC BIRMINGHAM /157-352/ 1P

BAPBOMB

DAILY SUMMARY.

SPOT CHECK AND INTERVIEW OF ASSOCIATES OF PRINCIPAL SUSPECTS
CONDUCTED WITH NO NEW PERTINENT INFO DEVELOPED.

[REDACTED]

COULD FURNISH NO NEW PERTINENT INFO RE ACTIVITIES OF [REDACTED]

[REDACTED] ADDITIONAL REPORT PREPARED AND WILL ARRIVE BUREAU
NEXT A.M.

TWENTY INTERVIEWS CONDUCTED TODAY. EIGHTYTHREE PENDING.

END

8-08 PM OK FBI AWA LLD

TU CLR

EX-108

REC-3

157-1025-697

DEC 8 1963

Rosen & Belmont 12/3/63
RBV: CAG

6-11

61 DEC 8 1963

hee

NOV 22 1963
TELETYPE

Mr. Tolson	_____
Mr. Belmont	_____
Mr. Mohr	_____
Mr. Casper	_____
Mr. Callahan	_____
Mr. Conrad	_____
Mr. DeLoach	_____
Mr. Evans	_____
Mr. Gale	_____
Mr. Rosen	<input checked="" type="checkbox"/>
Mr. Sullivan	_____
Mr. Tavel	_____
Mr. Trotter	_____
Tele. Room	_____
Miss Holmes	_____
Miss Gandy	_____

URGENT 11-22-63 7-50 PM CST HEP
 TO DIRECTOR /157-1025/
 FROM SAC-BIRMINGHAM /157-352/ 2P
 BAPBOMB. ET AL.
 DAILY SUMMARY.

ALL SUSPECTS CAPTIONED CASE LOCATED AND CONTACTED THIS DATE.
 NONE FURNISHED ANY ADDITIONAL INFORMATION OF SIGNIFICANCE.
 ADDITIONAL INVESTIGATION CONDUCTED RE THEIR FRIENDS, ASSOCIATES AND
 ACQUAINTANCES AND MUCH BACKGROUND OBTAINED BUT NO NEW EVIDENCE OF
 THEIR INVOLVEMENT IN BAPBOMB UNCOVERED.

[REDACTED SECTION]

END PAGE ONE

EX-117 157-1025-698
 REC-3
 12 DEC 3 1963
 [Handwritten signatures and initials]

59 DEC 9 1963

cc Lavin

FBI
JAN 22 1958

PAGE TWO.

[REDACTED]

5
↓

FIFTYONE INTERVIEWS TODAY. ONE HUNDRED EIGHTYFIVE PENDING.

END

8-58 PM OK FB WXX FBI WA WS

TU

C

FEDERAL BUREAU OF INVESTIGATION
U. S. DEPARTMENT OF JUSTICE
COMMUNICATIONS SECTION

NOV 23 1963

TELETYPE

Mr. Tolson	_____
Mr. Belmont	_____
Mr. Mohr	_____
Mr. Casper	_____
Mr. Callahan	_____
Mr. Conrad	_____
Mr. DeLoach	_____
Mr. Evans	_____
Mr. Gale	_____
Mr. Rosen	_____
Mr. Sullivan	_____
Mr. Tavel	_____
Mr. Trotter	_____
Tele. Room	_____
Miss Holmes	_____
Miss Gandy	_____

PK

✓
URGENT 11-23-63 9-49 PM CST HEP
TO DIRECTOR /157-1025/
FROM SAC BIRMINGHAM /157-352/ 3P
BAPBOMB. ET AL.
DAILY SUMMARY.

2 Copies made by *cy*
for review by Rowe Task Force
Date 1-8-79

CONFERENCE SPÉCIAL SQUAD HELD THIS DATE. IT IS OUR CONSENSUS
THE FOLLOWING ARE THE PRIME SUSPECTS DASH [REDACTED]

[REDACTED] ROBERT CHANBLISS, [REDACTED]

SECONDARY SUSPECTS ARE [REDACTED]

62c 10

[REDACTED]

[REDACTED]

[REDACTED]

[REDACTED]

[REDACTED]

[REDACTED]

[REDACTED]

[REDACTED]

[REDACTED] EXTENSIVE INVESTIGATION CONDUCTED TO LOCATE
WITNESSES OR CORROBORATING EVIDENCE AGAINST [REDACTED]

HOWEVER, THOSE WITNESSES LOCATED ARE UNABLE TO POSITIVELY IDENTIFY
EITHER STATING THEY SAW SUBJECTS ONLY IN SILHOUETTE. [REDACTED]

END PAGE ONE

Post Bell
DEC 6 1963
224

EX-112

REC-16

12 DEC 3 1963

157-1025-699
6-111

PAGE TWO.

[REDACTED]

[REDACTED] ACCEPTED MONEY AND SIGNED RECEIPT AND IN SO DOING HE REALIZED FULL WELL THE QUOTE HOLD END QUOTE AGENTS NOW HAVE ON HIM. EVERY ENDEAVOR BEING MADE TO QUOTE TURN END QUOTE OTHER ASSOCIATES OF PRIME SUSPECTS AND DEVELOP THEM AS INFORMERS. DURING FORTHCOMING WEEK EVERY FORMER ASSOCIATE OF PRIME SUSPECTS IN EASTVIEW AND BESSEMER KLAVERNS, BIRMINGHAM, WILL BE INTERVIEWED WITH THOUGHT IN MIND OF DEVELOPING THEM AS INFORMERS AGAINST PRIME OR SECONDARY SUSPECTS.

67010

[REDACTED]

END PAGE TWO.

PAGE THREE.

[REDACTED]

b7c 1D

LIVE INFORMER STATES KLAN HAD NO MEETING THIS WEEK AND NONE PLANNED NEXT WEEK DUE TO QUOTE ACTIVITIES END QUOTE OF FBI.

TWENTYFOUR INTERVIEWS THIS DATE. ONE HUNDRED SEVENTYSIX REMAINING.

END

10-59 PM OK FBI WA BH

BT

COMMUNICATIONS SECTION

NOV 53 11 07 AM '53

11 11

UNITED STATES GOVERNMENT

Memorandum

TO : Mr. Belmont

DATE: November 19, 1963

FROM : A. Rosen *AR*

SUBJECT: UNKNOWN SUBJECTS;
BOMBING OF 16TH STREET BAPTIST
CHURCH, BIRMINGHAM, ALABAMA, 9/15/63
BOMBING MATTERS

Baptist

Tolson	
Belmont	<input checked="" type="checkbox"/>
Mohr	<input checked="" type="checkbox"/>
Casper	<input checked="" type="checkbox"/>
Callahan	<input checked="" type="checkbox"/>
Conrad	<input checked="" type="checkbox"/>
DeLoach	<input checked="" type="checkbox"/>
Evans	<input checked="" type="checkbox"/>
Gale	<input checked="" type="checkbox"/>
Rosen	<input checked="" type="checkbox"/>
Sullivan	<input checked="" type="checkbox"/>
Tavel	<input checked="" type="checkbox"/>
Trotter	<input checked="" type="checkbox"/>
Tele. Room	<input checked="" type="checkbox"/>
Holmes	<input checked="" type="checkbox"/>
Gandy	<input checked="" type="checkbox"/>

*Get info re: subject
w/NA...
Birmingham
1-1
Larkin*

In connection with the assignment of personnel in instant investigation, this is being re-evaluated on a current basis.

In accordance with the Director's approval, 5 Special Agents and 4 clerks were released during the week of October 24, 1963, and subsequently, during the week of November 6, 5 additional Agents were released to return to their office of assignment. The matter of personnel has been re-evaluated on a current basis since then and it appears desirable to phase out by the close of business this week another 7 Agents and 1 stenographer. This will mean that we have reduced our special assignment fifty per cent as of this time. It appears that this will be sufficient personnel for the time being to continue the coverage of investigative leads, as well as to insure that there is no letdown in the pressure which is being exerted to bring about an early solution to this case. As indicated previously, each day results in the development of some piece of information indicating the activity is justified and appears to be in the right direction.

RECOMMENDATION:

If approved by the Director, it is planned that an additional 7 Agents and 1 stenographer will be instructed to return to their office of assignment by the close of business this week. The matter of personnel will be re-evaluated within ten days and appropriate recommendations submitted. If circumstances change in the meantime, you will be immediately advised.

- 1 - Mr. Mohr
- 1 - Mr. Callahan

R

AR:mpd:ige
(8)

*311
51
53 DEC 11 1963
assoc Birmingham
advised 11/21/63
by Rosen*

REC-22
V. 159-51025-100
OK
DEC 2 1963

FBI

Date: 11-26-63

Mr. [Handwritten Signature]

Transmit the following in _____
(Type in plain text or code)

Via AIRTEL AIR MAIL
(Priority or Method of Mailing)

TO: DIRECTOR, FBI
FROM: SAC, BIRMINGHAM (157-352)
BAPBOMB

Call [Handwritten]

On November 13, 1963, JERRY DUTTON, of the NATIONAL STATES RIGHTS PARTY, obtained warrants in Recorders' Court, Birmingham, Alabama, charging Special Agents [redacted] and [redacted] each with trespass after warning and disorderly conduct in connection with an investigative inquiry at NSRP Headquarters. This matter has been discussed with U. S. Attorney MACON L. WEAVER, who was of the opinion that the charges are frivolous and do not carry much weight and could probably be dismissed in Recorders' Court. Mr. WEAVER stated, however, that he had discussed this matter with Deputy Attorney General KATZENBACH, who indicated it was his recollection that incidents of this type would normally be handled in Federal Court.

Mr. WEAVER asked how I felt about the matter, and I told him that as our legal representative I did not want to interfere with his prerogative of determining the best way of affording protection to the agents through legal means in connection with this matter. I did point out, however, that I felt appropriate consideration should be given to transfer of this case into Federal Court under Section 1442, Title 28, U. S. Code, in view of the fact that our agents were engaged on an official investigation and as such were entitled to whatever protection they should have by virtue of the Federal Statutes.

Mr. WEAVER stated that although he originally felt strongly that there might be some adverse publicity if the charges against the agents were not disposed of in state court

3 - Bureau - AM
3 - Birmingham
2 - 157-352
1 - 105-477 (NSRP)

REC-3 157-1025-701

12 NOV 29 1963

Approved: _____
Special Agent in Charge

Sent _____ M Per _____

2 DEC 3 1963

[Handwritten initials and stamps]

BH 157-352

because of the incidents at Selma, Alabama, where Justice Department officials have refused to make Departmental Attorneys available in state court, he now feels that since the assassination of the Late President JOHN F. KENNEDY there has been a change in the attitude of many people and that it would be possible to transfer this to Federal Court. He indicated he would take action to have this matter transferred to Federal Court this week, and this will be done UACB.

UNITED STATES GOVERNMENT

Memorandum

Tolson	_____
Belmont	_____
Mohr	_____
Casper	_____
Callahan	_____
Conrad	_____
DeLoach	_____
Evans	_____
Gale	_____
Rosen	_____
Sullivan	_____
Tavel	_____
Trotter	_____
Tele. Room	_____
Holmes	_____
Gandy	_____

TO : Mr. Belmont *alor*

DATE: November 26, 1963

FROM : A. Rosen *✓*

SUBJECT: UNKNOWN SUBJECTS;
 BOMBING OF SIXTEENTH
 STREET BAPTIST CHURCH
 BIRMINGHAM, ALABAMA
 SEPTEMBER 15, 1963
 BOMBING MATTERS

BARBONIS

247,392
 ALL INFORMATION CONTAINED
 HEREIN IS UNCLASSIFIED
 DATE *3-10-86* BY *SP4EJW/JEW*

While Governor George Wallace, the political figure most closely identified with the views and beliefs of suspect Klan and National States Rights Party (NSRP) members, made an appearance at the funeral of President Kennedy in Washington yesterday

[REDACTED]

However, another reliable informant reports the Klan has had no meeting this week and none is planned due to FBI "activities."

[REDACTED]

[REDACTED]

- 1 - Mr. Mohr
- 1 - Mr. DeLoach
- 1 - Mr. Evans

HET:cac
(9)

63-104
 60 DEC 6 1963
 XEROX
 196 DEC 3 1963
724

REC-26
 157-1025-702
 UNRECORDED COPY FILED IN
 60 DEC 8 1963
 60-108

Memorandum to Mr. Belmont
RE: UNKNOWN SUBJECTS; BOMBING OF
SIXTEENTH STREET BAPTIST CHURCH

As a result of conferences of Agents working on the bombing cases in Birmingham, it was agreed that the following remain as prime suspects:

Robert Chambliss
suspects are

Secondary

has also accepted money for securing information and realizes full well the "hold" Agents now have on him.

62c
Memorandum to Mr. Belmont
RE: UNKNOWN SUBJECTS; BOMBING OF
SIXTEENTH STREET BAPTIST CHURCH

[REDACTED]
Numerous other interviews were conducted 11/23-25/63;
however, no pertinent information was obtained.

ACTION

You will be kept advised of developments.

A

✓

R

A

UNITED STATES GOVERNMENT

Tolson	_____
Belmont	_____
Mohr	_____
Casper	_____
Callahan	_____
Conrad	_____
DeLoach	✓
Evans	_____
Gale	_____
Rosen	✓
Sullivan	_____
Tavel	_____
Trotter	_____
Tele. Room	_____
Holmes	_____
Gandy	_____

RA

Memorandum

TO : Mr. Belmont *albo*

DATE: November 30, 1963

FROM : A. Rosen *Rosen*

SUBJECT: UNKNOWN SUBJECTS;
BOMBING OF SIXTEENTH
STREET BAPTIST CHURCH
BIRMINGHAM, ALABAMA
SEPTEMBER 15, 1963
BOMBING MATTERS

62-10

With further reference to the information developed from [REDACTED]

[REDACTED]

Although the car to which Chambliss apparently would have had access is a 1956 Ford rather than a 1957 Ford, it is of the same color as the car described by [REDACTED]

62-10

This phase of the investigation is being closely followed.

62-10

After the arrest of National States Rights Party (NSRP) member Jerry Dutton on October 30, 1963, for his making a false trespass complaint to the Birmingham Police Department against SAs [REDACTED] and [REDACTED] it will be recalled that Edward R. Fields, NSRP leader, signed complaints against Agents [REDACTED] and [REDACTED] charging them with trespass and disorderly conduct, and the Agents on the recommendation of the Office of the United States Attorney, Birmingham, met with Chief of Police Jamie Moore, Birmingham, on November 14, 1963, to accept service of the warrants.

Albo

United States Attorney Macon L. Weaver has advised that the charges cooked up by the NSRP do not carry much weight and could probably be dismissed in Recorders Court.

- 1 - Mr. Mohr
- 1 - Mr. DeLoach
- 1 - Mr. Evans

HET:nkr
(9)

REC-26

157-1025-703

11 DEC 3 1963

ST-104

PERS./REC. UNIT

72 DEC 1963

Memorandum to Mr. Belmont
RE: UNKNOWN SUBJECTS; BOMBING
OF SIXTEENTH STREET BAPTIST CHURCH

Mr. Weaver stated he has discussed this matter with Assistant Attorney General Nicholas Katzenbach whose opinion was that situations of this type would usually be handled in Federal court. Although Mr. Weaver originally felt strongly that there might be some adverse publicity if the charges against the Agents were not disposed of in state court because of the incidents at Selma, Alabama, in which the Department refused to make Departmental attorneys available in state court, he now feels that since the assassination of President Kennedy there has been a change in the attitude of many people and as a consequence feels it would be possible to transfer this action to the Federal court without incurring adverse publicity. Accordingly, Mr. Weaver plans to take action to have the matter transferred to Federal court in the next few days.

The concentrated endeavor to "turn" other associates of the prime suspects in this case to develop them as informants continued on November 29, 1963, through the interview of additional members of the Eastview and Bessemer Klaverns in the Birmingham area.

ACTION:

You will be kept advised of developments.

Handwritten initials and marks:
A large handwritten 'Q' on the left.
A large handwritten 'Q' in the center.
Handwritten initials 'J. J. G.' above the center 'Q'.
Handwritten initials 'R. R.' to the right of the center 'Q'.
A checkmark '✓' in the upper right corner.

UNITED STATES GOVERNMENT

Memorandum

<i>M</i>	Tolson	_____
	Belmont	_____
	Mohr	_____
	Casper	_____
	Callahan	_____
	Conrad	_____
	DeLoach	_____
	Evans	_____
	Gale	_____
	Rosen	_____
	Sullivan	_____
	Tavel	_____
	Trotter	_____
	Tele. Room	_____
	Holmes	_____
	Gandy	_____

TO : Mr. Belmont *W*

DATE: November 29, 1963

FROM : A. Rosen *R*

SUBJECT: UNKNOWN SUBJECTS;
 BOMBING OF SIXTEENTH
 STREET BAPTIST CHURCH
 BIRMINGHAM, ALABAMA
 SEPTEMBER 15, 1963
 BOMBING MATTERS

BAPBOMB

67c 10

[REDACTED]

[REDACTED]

[REDACTED]

Intensive efforts to identify the car and to develop corroborating evidence have been to no avail.

[REDACTED]

67c 10

[REDACTED]

- 1 - Mr. Mohr
- 1 - Mr. DeLoach
- 1 - Mr. Evans

RBL:cac
(9)

hee

REC-26

157-1025-704

FOI-IS

12 DEC 3 1963

6

Memorandum to Mr. Belmont
RE: UNKNOWN SUBJECTS; BOMBING OF
SIXTEENTH STREET BAPTIST CHURCH

WCS

ALB

[REDACTED]

[REDACTED]

Additional members of the Bessemer and Eastview Klaverns were interviewed on 11-27 and 11-28-63 with no additional information being developed.

ACTION

You will be advised of developments.

✓

Q

Chapman

Rg

[Signature]

Date of Mail 11-21-63

2 Copies made by CT
for review by Rowe Task Force
Date 1-8-79

Has been removed and placed in the Special File Room of Records Branch.

See File 66-2554-7530 for authority.

Subject JUNE MAIL Baybambi

Removed By 65 DEC 11 1963

File Number 157-1025-706

Permanent Serial Charge Out

XXXXXX
XXXXXX
XXXXXX

FEDERAL BUREAU OF INVESTIGATION FOIPA DELETED PAGE INFORMATION SHEET

2 Page(s) withheld entirely at this location in the file. One or more of the following statements, where indicated, explain this deletion.

Deleted under exemption(s) (b)(2), (b)(7)(C) and (D) with no segregable material available for release to you.

Information pertained only to a third party with no reference to you or the subject of your request.

Information pertained only to a third party. Your name is listed in the title only.

Documents originated with another Government agency(ies). These documents were referred to that agency(ies) for review and direct response to you.

_____ Pages contain information furnished by another Government agency(ies). You will be advised by the FBI as to the releasability of this information following our consultation with the other agency(ies).

_____ Page(s) withheld for the following reason(s):

For your information: _____

The following number is to be used for reference regarding these pages:
157-1025-706

XXXXXX
XXXXXX
XXXXXX

XXXXXXXXXXXXXXXXXXXXX
X DELETED PAGE(S) X
X NO DUPLICATION FEE X
X FOR THIS PAGE X
XXXXXXXXXXXXXXXXXXXXX

Date of Mail 11-27-63

✓ Copies made by CR
for review by Rowe Task Force
Date 1-8-79

Has been removed and placed in the Special File Room of Records Branch.

See File 66-2554-7530 for authority.

Subject JUNE MAIL *Baptists*

Removed By 65 DEC 11 1963

File Number 157-1025-707

XXXXXX
XXXXXX
XXXXXX

FEDERAL BUREAU OF INVESTIGATION FOIPA DELETED PAGE INFORMATION SHEET

3

Page(s) withheld entirely at this location in the file. One or more of the following statements, where indicated, explain this deletion.

Deleted under exemption(s) (b) (7) (C) and (D) with no segregable material available for release to you.

Information pertained only to a third party with no reference to you or the subject of your request.

Information pertained only to a third party. Your name is listed in the title only.

Documents originated with another Government agency(ies). These documents were referred to that agency(ies) for review and direct response to you.

_____ Pages contain information furnished by another Government agency(ies). You will be advised by the FBI as to the releasability of this information following our consultation with the other agency(ies).

_____ Page(s) withheld for the following reason(s):

For your information: _____

The following number is to be used for reference regarding these pages:
157-1025-207

XXXXXX
XXXXXX
XXXXXX

XXXXXXXXXXXXXXXXXXXXX
X DELETED PAGE(S) X
X NO DUPLICATION FEE X
X FOR THIS PAGE X
XXXXXXXXXXXXXXXXXXXXX

Date of Mail 11-15-63

Copies made by CT
for review by Rowe Task Force
Date 1-8-79

Has been removed and placed in the Special File Room of Records Branch.

See File 66-2554-7530 for authority.

Subject JUNE MAIL Bayboubi

65 DEC 11 1963

Removed By _____

File Number 157-1025-708

Permanent Serial Charge Out

XXXXXX
XXXXXX
XXXXXX

**FEDERAL BUREAU OF INVESTIGATION
FOIPA DELETED PAGE INFORMATION SHEET**

4 Page(s) withheld entirely at this location in the file. One or more of the following statements, where indicated, explain this deletion.

Deleted under exemption(s) b2, b7 and D with no segregable material available for release to you.

Information pertained only to a third party with no reference to you or the subject of your request.

Information pertained only to a third party. Your name is listed in the title only.

Documents originated with another Government agency(ies). These documents were referred to that agency(ies) for review and direct response to you.

_____ Pages contain information furnished by another Government agency(ies). You will be advised by the FBI as to the releasability of this information following our consultation with the other agency(ies).

_____ Page(s) withheld for the following reason(s):

For your information: _____

The following number is to be used for reference regarding these pages:
157-1025-20A

XXXXXX
XXXXXX
XXXXXX

XXXXXXXXXXXXXXXXXXXXX
X DELETED PAGE(S) X
X NO DUPLICATION FEE X
X FOR THIS PAGE X
XXXXXXXXXXXXXXXXXXXXX

Date of Mail 11-15-63

2 copies made by G
by the Task Force
Date 1-8-79

Has been removed and placed in the Special File Room of Records Branch.

See File 66-2554-7530 for authority.

Subject JUNE MAIL Baybamb

Removed By 65 DEC 11 1968

File Number 157-1025-709

XXXXXX
XXXXXX
XXXXXX

FEDERAL BUREAU OF INVESTIGATION
FOIPA DELETED PAGE INFORMATION SHEET

4 Page(s) withheld entirely at this location in the file. One or more of the following statements, where indicated, explain this deletion.

Deleted under exemption(s) b2, b7c and D with no segregable material available for release to you.

Information pertained only to a third party with no reference to you or the subject of your request.

Information pertained only to a third party. Your name is listed in the title only.

Documents originated with another Government agency(ies). These documents were referred to that agency(ies) for review and direct response to you.

_____ Pages contain information furnished by another Government agency(ies). You will be advised by the FBI as to the releasability of this information following our consultation with the other agency(ies).

_____ Page(s) withheld for the following reason(s):

For your information: _____

The following number is to be used for reference regarding these pages:
157-1025-709

XXXXXX
XXXXXX
XXXXXX

XXXXXXXXXXXXXXXXXXXXX
X DELETED PAGE(S) X
X NO DUPLICATION FEE X
X FOR THIS PAGE X
XXXXXXXXXXXXXXXXXXXXX

Date of Mail 11-15-63

2 Copies made by GT
for review by Rowe Task Force
Date 1/8/77

Has been removed and placed in the Special File Room of Records Branch.

See File 66-2554-7530 for authority.

Subject JUNE MAIL Bap bomb

Removed By 65 DEC 11 1983

File Number 157-1025-710

XXXXXX
XXXXXX
XXXXXX

FEDERAL BUREAU OF INVESTIGATION
FOIPA DELETED PAGE INFORMATION SHEET

4

Page(s) withheld entirely at this location in the file. One or more of the following statements, where indicated, explain this deletion.

- Deleted under exemption(s) (b)(2) (b)(7)(D) with no segregable material available for release to you.
- Information pertained only to a third party with no reference to you or the subject of your request.
- Information pertained only to a third party. Your name is listed in the title only.
- Documents originated with another Government agency(ies). These documents were referred to that agency(ies) for review and direct response to you.

_____ Pages contain information furnished by another Government agency(ies). You will be advised by the FBI as to the releasability of this information following our consultation with the other agency(ies).

_____ Page(s) withheld for the following reason(s):

For your information: _____

The following number is to be used for reference regarding these pages:

157 - 1025 - 710

XXXXXX
XXXXXX
XXXXXX

XXXXXXXXXXXXXXXXXXXXX
X DELETED PAGE(S) X
X NO DUPLICATION FEE X
X FOR THIS PAGE X
XXXXXXXXXXXXXXXXXXXXX

FEDERAL BUREAU OF INVESTIGATION
U. S. DEPARTMENT OF JUSTICE
COMMUNICATIONS SECTION

DEC 4 1963

TELETYPE

Mr. Tolson	_____
Mr. Belmont	_____
Mr. Mohr	_____
Mr. Casper	_____
Mr. Callahan	_____
Mr. Conrad	_____
Mr. DeLoach	_____
Mr. Evans	_____
Mr. Gale	_____
Mr. Rosen	_____
Mr. Sullivan	_____
Mr. Tavel	_____
Mr. Trotter	_____
Tele. Room	_____
Miss Holmes	_____
Miss Gandy	_____

URGENT 12-4-63 8-43 PM CST HEP

TO DIRECTOR /157-1025/

FROM SAC BIRMINGHAM /157-352/ 2P

BAPBOMB

DAILY SUMMARY.

EFFORTS TO LOCATE AND IDENTIFY FIFTYSEVEN FORD TUDOR SEDAN
OBSERVED AT SIGHT OF BAPBOMB BOMBING ABOUT TWO WEEKS BEFORE ACTUAL
BOMBING CONTINUING.

[REDACTED SECTION]

END PAGE ONE
68 DEC 9 1963

Rosen *Belmont* 12/5/63

6-*PK*

PAGE TWO.

b7c
b7d

[REDACTED]

ALA

ROBERT E. ~~CHAMBLISS~~ RETURNED TO HIS RESIDENCE ELEVEN P.M.,
DECEMBER THREE FROM TWO DAY TRIP TO SOUTH ALABAMA AND PANAMA
CITY, FLORIDA, IN CONNECTION WITH HIS BUSINESS.

SPOT CHECKS OF PRIME SUSPECTS AT RESIDENCES AND PLACES OF
EMPLOYMENT CONTINUED WITHOUT UNUSUAL ACTIVITIES NOTED.

THIRTYFOUR INTERVIEWS CONDUCTED. ESTIMATED SEVENTYFIVE
REMAINING.

END

9-48 PM OK FBI WA LLD

0

XXXXXX
XXXXXX
XXXXXX

FEDERAL BUREAU OF INVESTIGATION
FOIPA DELETED PAGE INFORMATION SHEET

2 Page(s) withheld entirely at this location in the file. One or more of the following statements, where indicated, explain this deletion.

Deleted under exemption(s) (b)(7)(C) and (D) with no segregable material available for release to you.

Information pertained only to a third party with no reference to you or the subject of your request.

Information pertained only to a third party. Your name is listed in the title only.

Documents originated with another Government agency(ies). These documents were referred to that agency(ies) for review and direct response to you.

_____ Pages contain information furnished by another Government agency(ies). You will be advised by the FBI as to the releasability of this information following our consultation with the other agency(ies).

_____ Page(s) withheld for the following reason(s):

For your information: _____

The following number is to be used for reference regarding these pages:

157-1625-712

XXXXXX
XXXXXX
XXXXXX

XXXXXXXXXXXXXXXXXXXXX
X DELETED PAGE(S) X
X NO DUPLICATION FEE X
X FOR THIS PAGE X
XXXXXXXXXXXXXXXXXXXXX

FEDERAL BUREAU OF INVESTIGATION
DEPARTMENT OF JUSTICE
COMMUNICATIONS SECTION
DEC 5 1963

TELETYPE

Mr. Tolson	_____
Mr. Belmont	_____
Mr. Mohr	_____
Mr. Casper	_____
Mr. Callahan	_____
Mr. Conrad	_____
Mr. DeLoach	_____
Mr. Evans	_____
Mr. Gale	_____
Mr. Rosen	_____
Mr. Sullivan	_____
Mr. Tavel	_____
Mr. Trotter	_____
Tele. Room	_____
Miss Holmes	_____
Miss Gandy	_____

URGENT 12-5-63 7-43 PM CST HEP
TO DIRECTOR /157-1025/
FROM SAC BIRMINGHAM /157-352/ 2P

OBAPBOMB.

DAILY SUMMARY.
PHYSICAL SURVEILLANCE
FISUR OF THOMAS E. BLANTON, SR., [REDACTED]

[REDACTED] REVEALED VISIT BY HIM THIS DATE TO WEST END BRANCH,
FIRST NATIONAL BANK OF BIRMINGHAM WHERE HE REMAINED APPROXIMATELY
ONE HALF HOUR AND EMERGED WITH SEVERAL PAPERS AS THOUGH NEGOTIATING
LOAN. THIS WILL BE FOLLOWED.

AT TRIAL OF JERRY DUTTON, NSRP OFFICIAL, IN BIRMINGHAM CITY
RECORDERS COURT, ENSLEY PRECINCT, TODAY ON CHARGES OF HAVING MADE
A FICTITIOUS COMPLAINT TO BIRMINGHAM PD ON OCTOBER THIRTY, LAST,
DUTTON WAS FINED FIFTY DOLLARS AND SENTENCED TO SIXTY DAYS IN JAIL,
THE JAIL SENTENCE BEING SUSPENDED. SAS [REDACTED] AND [REDACTED]
[REDACTED] APPEARED AS STATE WITNESSES. THE INCIDENT INVOLVING
ARREST OF DUTTON OCCURRED AT NSRP HEADQUARTERS, BIRMINGHAM, WHEN
DUTTON CALLED BIRMINGHAM PD ALLEGING AGENTS WERE COMMUNISTS, ALTHOUGH

END PAGE ONE

66DL 12/6/63
25/ 12/6/63 RBL CAG

6

PAGE TWO.

THEY HAD IDENTIFIED THEMSELVES AS AGENTS THERE ON OFFICIAL BUSINESS. AN OFFICER OF BIRMINGHAM PD TESTIFIED THAT THE FALSE CALL RESULTED IN ABOUT SIX CARS OF BIRMINGHAM PD ANSWERING THE CALL.

DUTTON/S ATTORNEY, MATT MURPHY, ACCORDING TO CITY PROSECUTING ATTORNEY BILL THOMPSON HAS MADE NECESSARY ARRANGEMENTS TO APPEAL THE CONVICTION AND IF SO THE CASE WOULD BE TRIED IN CIRCUIT COURT AT BIRMINGHAM WITHIN APPROXIMATELY FOUR MONTHS.

625 [REDACTED] ARRIVED BIRMINGHAM TODAY FROM ATLANTA AND OBSERVED AT NSRP HEADQUARTERS AFTER DUTTON/S TRIAL. LENGTH OF HIS VISIT TO BIRMINGHAM NOT KNOWN BUT EFFORTS WILL BE MADE TO COVER [REDACTED] ACTIVITIES WHILE HERE. HE IS DRIVING SAME FIFTYEIGHT OLDSMOBILE CONVERTIBLE PREVIOUSLY IN HIS POSSESSION. BIRMINGHAM PD COGNIZANT.

INTERVIEWS CONDUCTED TODAY THIRTYTHREE. INTERVIEWS CONTEMPLATED SIXTYFIVE.

END

8-56 PM OK FBI WA WS

PLS CORRECT TIME TO 7-48 PM

OK

CLR

UNITED STATES GOVERNMENT

Memorandum

TO : DIRECTOR, FBI

DATE: 11/27/63

308
CMZ

FROM : SAC, KNOXVILLE (157-190) (RUC)

SUBJECT: THEFT OF FOUR CASES OF DYNAMITE, *André De Nemours,*
E. I. DUPONT COMPANY, STORAGE MAGAZINE, *E. I. Du Pont Company*
WALKER COUNTY, GEORGIA
9/18/63
INTERSTATE TRANSPORTATION OF EXPLOSIVES

OO: ATLANTA

Re Knoxville teletype to Director and Atlanta dated 9/19/63. *(157-1025-65)*

Continued contacts have been made with local law enforcement agencies, Chattanooga and vicinity, and with other sources. No information has been developed concerning identity of subjects in this case.

This case is being placed in RUC status subject to be reopened in event any pertinent information is brought to the attention of the Knoxville Office.

Vertical stamp or markings on the right margin.

9/10/63

- 2 - Bureau
- 1 - Atlanta (Info)
- 1 - Knoxville

ST-105

[Redacted area] *L2c*

REC-125

157-1025-714

NOV 29 1963

DEC 11 1963

Handwritten initials or signature at the bottom.

UNITED STATES GOVERNMENT

Memorandum

BA

TO : The Director

DATE:

11/5/63

FROM : N. P. Callahan

SUBJECT: The Congressional Record

OBap bomb

Pages A6879-A6880. Congressman Huddleston, (D) Alabama, extended his remarks to include an editorial from the October 24, 1963, issue of the Alabama Baptist, edited by Dr. Leon Macon. This editorial stated "The attitude of the white people toward the bombings in Birmingham is one of appall, protest, and complete disgust with the guilty parties. That these crimes could have been caused by outsiders is seen in the fact that 25 FBI men could not solve the problem or point their fingers to the guilty ones. Our law enforcement officers have been firm, calm, and efficient, and humane in their treatment of those creating demonstrations, both white and black. They have done an excellent job in spite of some reports that our law enforcement in Birmingham is poor."

66-1731-2425

Original filed in:

157-1025-
NOT RECORDED
128 DEC 13 1963

604

In the original of a memorandum captioned and dated as above, the Congressional Record for 11/4/63 was reviewed and pertinent items were marked for the Director's attention. This form has been prepared in order that portions of a copy of the original memorandum may be clipped, mounted, and placed in appropriate Bureau case or subject matter files.

UNITED STATES GOVERNMENT

Memorandum

Tolson	_____
Belmont	_____
Mohr	_____
Casper	_____
Callahan	_____
Conrad	_____
DeLoach	_____
Evans	_____
Gale	_____
Rosen	_____
Sullivan	_____
Tavel	_____
Trotter	_____
Tele. Room	_____
Holmes	_____
Gandy	_____

TO : Mr. Belmont

DATE: December 2, 1963

FROM : A. Rosen

SUBJECT: UNKNOWN SUBJECTS;
BOMBING OF SIXTEENTH
STREET BAPTIST CHURCH
BIRMINGHAM, ALABAMA
SEPTEMBER 15, 1963
BOMBING MATTERS

Handwritten signatures and initials:
Lampkin
DJ. Bishop
M. J. G. [unclear]

Large redacted area (blacked out text)

67D

Over the week end spot check surveillances and interviews of the principal suspects in the bombing of the Sixteenth Street Baptist Church and other bombings in Birmingham were conducted with no significant information being developed.

67D

Large redacted area (blacked out text)

It should be noted that after the premature arrests of three suspects by the Alabama Highway Patrol in September, 1963, the principal suspects in this case have become very wary about their activities and statements and are hostile when interviews are attempted with them.

REC-86
V. 157-1025-715
4

ACTION:

You will be advised of developments.

- 1 - Mr. Mohr
- 1 - Mr. DeLoach
- 1 - Mr. Evans

Handwritten signatures and initials:
Rosen
[unclear]

RBL:cag (9)

Handwritten notes:
25
[unclear]

FBI

Date: 11/27/63

Transmit the following in _____
(Type in plain text or code)

Via AIRTEL AIRMAIL
(Priority or Method of Mailing)

TO: DIRECTOR, FBI (157-1025)

FROM: SAC, BIRMINGHAM (157-352) (P)

RE: BAPBOMB

Rerep SA [REDACTED] 11/15/63, BH.

Re: Suspect [REDACTED]

[REDACTED]

[REDACTED]

[REDACTED]

[REDACTED]

[REDACTED]

[REDACTED]

[REDACTED]

3 - Bureau
3 - Birmingham (2 - 157-352)
1 - 157-401

REC-18

C. G. Wick

Approved: _____
(6) Special Agent in Charge

Sent EX-108

M 4 Per 12-5

[Handwritten signatures and initials]

62-10

11/27/63

BH 157-352

69-10

[REDACTED]

It is felt that no useful purpose would be served in preparing and disseminating memoranda concerning frank revelations and, in fact, such memoranda might destroy any future assistance she might possibly be to the FBI.

UACB, disseminating memoranda will not be prepared in absence of any derogatory information which might come to the attention of this office in the future.

XXXXXX
XXXXXX
XXXXXX

**FEDERAL BUREAU OF INVESTIGATION
FOIPA DELETED PAGE INFORMATION SHEET**

 1 Page(s) withheld entirely at this location in the file. One or more of the following statements, where indicated, explain this deletion.

- Deleted under exemption(s) (b)(7)(C) & (b)(7)(D) with no segregable material available for release to you.
- Information pertained only to a third party with no reference to you or the subject of your request.
- Information pertained only to a third party. Your name is listed in the title only.
- Documents originated with another Government agency(ies). These documents were referred to that agency(ies) for review and direct response to you.

 Pages contain information furnished by another Government agency(ies). You will be advised by the FBI as to the releasability of this information following our consultation with the other agency(ies).

 Page(s) withheld for the following reason(s):

For your information: _____

The following number is to be used for reference regarding these pages:
 157-1025-716

XXXXXX
XXXXXX
XXXXXX

XXXXXXXXXXXXXXXXXXXXX
X DELETED PAGE(S) X
X NO DUPLICATION FEE X
X FOR THIS PAGE X
XXXXXXXXXXXXXXXXXXXXX

Date of Mail 2-2-63

Has been removed and placed in the Special File Room of Records Branch.

2 Copies made by CS
for review by Rowe Task Force
Date 1-8-71

See File 66-2554-7530 for authority.

Subject JUNE MAIL Bapbanti

Removed By 65 DEC 11 1963

File Number 157-1025-717

Permanent Serial Charge Out

UNITED STATES GOVERNMENT

Memorandum

Tolson	_____
Belmont	_____
Mohr	_____
Casper	_____
Callahan	_____
Conrad	_____
DeLoach	_____
Evans	_____
Gale	_____
Rosen	_____
Sullivan	_____
Tavel	_____
Trotter	_____
Tele. Room	_____
Holmes	_____
Gandy	_____

TO : Mr. Belmont *AB*

DATE: December 2, 1963

FROM : A. Rosen *AR*

JUNE

SUBJECT: UNKNOWN SUBJECTS;
BOMBING OF SIXTEENTH
STREET BAPTIST CHURCH
BIRMINGHAM, ALABAMA
SEPTEMBER 15, 1963
RACIAL MATTERS

L.H.V. [Signature]

On 12/2/63, SAC Faisst of the Birmingham Office requested authority for a survey and installation of a microphone surveillance on the residence of Robert Edward Chambliss, 2505 32nd Avenue, North, Birmingham, Alabama, a prime suspect in this case.

It is hoped that through this microphone surveillance information will be developed leading to the identity of the perpetrators of the bombing of the Sixteenth Street Baptist Church in which four small Negro children were killed.

SAC Faisst assured that the surveillance can be installed with full security.

ACTION:

That authority for the installation be granted and the attached teletype be sent to Birmingham.
Enclosure
1 - Mr. Sullivan
1 - Mr. Donahue

JCT:nkr
(7)

Q

*Close
DK
[Signature]*

[Signature]

Cl

157-1025-717

EX-113

78

22 DEC 9 1963

COMM. SECT. RM.

12/2/63

CODE

TELETYPE

DEFERRED

REC-48 157-1025-177

TO SAC BIRMINGHAM

FROM DIRECTOR FBI

C
BAPBOMB, JUNE.

REURTELCALL THIS DATE CONCERNING INSTALLATION OF MISUR RE
ROBERT CHAMBLISS.

AUTHORITY GRANTED FOR SURVEY AND INSTALLATION OF MISUR
PROVIDING FULL SECURITY CAN BE ASSURED. ADVISE DATE OF
INSTALLATION, SYMBOL NUMBER AND THE LOCATION OF PLANT. FURNISH
INFORMATION CONCERNING ELEMENTS OF TRESPASS.

RED:nkr
(9)

NOTE: See Rosen to Belmont memo, 12/2/63, captioned as
above, JCT:nkr.

MR.	<i>02 23 46</i>
ENC.	
CK.	<i>Jud con</i>
APPROVED BY	<i>[Signature]</i>
TYPED BY	

DEC 12 1963
 VIA TELETYPE
 ENCIPHERED

- Tolson _____
- Belmont _____
- Mohr _____
- Casper _____
- Callahan _____
- Conrad _____
- DeLoach _____
- Evans _____
- Gale _____
- Rosen _____
- Sullivan _____
- Tavel _____
- Trotter _____
- Tele. Room _____
- Holmes _____
- Gandy _____

DEC 13 1963

DEC 11 1963 TELETYPE UNIT

Date of Mail 11-15-63

Has been removed and placed in the Special File Room of Records Branch.

2 copies made by LT
for review by Howe Task Force
Date 1-8-78

See File 66-2554-7530 for authority.

Subject JUNE MAIL Baybank

Removed By 66 Dec 11 1963

File Number 157-1025-718

XXXXXX
XXXXXX
XXXXXX

**FEDERAL BUREAU OF INVESTIGATION
FOIPA DELETED PAGE INFORMATION SHEET**

4 Page(s) withheld entirely at this location in the file. One or more of the following statements, where indicated, explain this deletion.

Deleted under exemption(s) (b)(7)(c) and (D) with no segregable material available for release to you.

Information pertained only to a third party with no reference to you or the subject of your request.

Information pertained only to a third party. Your name is listed in the title only.

Documents originated with another Government agency(ies). These documents were referred to that agency(ies) for review and direct response to you.

_____ Pages contain information furnished by another Government agency(ies). You will be advised by the FBI as to the releasability of this information following our consultation with the other agency(ies).

_____ Page(s) withheld for the following reason(s):

For your information: _____

The following number is to be used for reference regarding these pages:
157-1025-712

XXXXXX
XXXXXX
XXXXXX

XXXXXXXXXXXXXXXXXXXXX
X DELETED PAGE(S) X
X NO DUPLICATION FEE X
X FOR THIS PAGE X
XXXXXXXXXXXXXXXXXXXXX

Date of Mail 11-7-63

Has been removed and placed in the Special File Room of Records Branch.

See File 66-2554-7530 for authority.

2 Copies made by 4
for review by Rowe Task Force
1-8-79

Subject JUNE MAIL Baybonds

63 DEC 11 1963

Removed By _____

File Number 157-1025-719

XXXXXX
XXXXXX
XXXXXX

**FEDERAL BUREAU OF INVESTIGATION
FOIPA DELETED PAGE INFORMATION SHEET**

4 Page(s) withheld entirely at this location in the file. One or more of the following statements, where indicated, explain this deletion.

Deleted under exemption(s) (b) (7) (c) with no segregable material available for release to you.

Information pertained only to a third party with no reference to you or the subject of your request.

Information pertained only to a third party. Your name is listed in the title only.

Documents originated with another Government agency(ies). These documents were referred to that agency(ies) for review and direct response to you.

_____ Pages contain information furnished by another Government agency(ies). You will be advised by the FBI as to the releasability of this information following our consultation with the other agency(ies).

_____ Page(s) withheld for the following reason(s):

For your information: _____

The following number is to be used for reference regarding these pages:
157-1025-719

XXXXXX
XXXXXX
XXXXXX

XXXXXXXXXXXXXXXXXXXXX
X DELETED PAGE(S) X
X NO DUPLICATION FEE X
X FOR THIS PAGE X
XXXXXXXXXXXXXXXXXXXXX

Date of Mail 11-17-63

Has been removed and placed in the Special File Room of Records Branch.

2000 copies by 9
for the House Task Force
Date 1-8-79

See File 66-2554-7530 for authority.

Subject JUNE MAIL Bay Bomb

Removed By 68 DEC 11 1963

File Number 157-1025-720

XXXXXX
XXXXXX
XXXXXX

FEDERAL BUREAU OF INVESTIGATION FOIPA DELETED PAGE INFORMATION SHEET

4 Page(s) withheld entirely at this location in the file. One or more of the following statements, where indicated, explain this deletion.

Deleted under exemption(s) (b) (7)(c) with no segregable material available for release to you.

Information pertained only to a third party with no reference to you or the subject of your request.

Information pertained only to a third party. Your name is listed in the title only.

Documents originated with another Government agency(ies). These documents were referred to that agency(ies) for review and direct response to you.

_____ Pages contain information furnished by another Government agency(ies). You will be advised by the FBI as to the releasability of this information following our consultation with the other agency(ies).

_____ Page(s) withheld for the following reason(s):

For your information: _____

The following number is to be used for reference regarding these pages:
157-1025-720

XXXXXX
XXXXXX
XXXXXX

XXXXXXXXXXXXXXXXXXXXX
X DELETED PAGE(S) X
X NO DUPLICATION FEE X
X FOR THIS PAGE X
XXXXXXXXXXXXXXXXXXXXX

Date of Mail 11-14-63

Has been removed and placed in the Special File Room of Records Branch.

2 Copies made by g
for review by the Task Force
Date 1-8-79

See File 66-2554-7530 for authority.

Subject JUNE MAIL Babcock

Removed By 65 DEC 12 1963

File Number 157-1025-721

Permanent Serial Charge Out

UNITED STATES GOVERNMENT

Memorandum

Tolson	_____
Belmont	_____
Mohr	_____
Casper	_____
Callahan	_____
Conrad	_____
DeLoach	_____
Evans	_____
Gale	_____
Rosen	_____
Sullivan	_____
Tavel	_____
Trotter	_____
Tele. Room	_____
Holmes	_____
Gandy	_____

TO : Mr. Belmont *clerk*

DATE: JUNE November 14, 1963

FROM : A. Rosen *AR*

SUBJECT: UNKNOWN SUBJECTS; BOMBING OF
SIXTEENTH STREET BAPTIST CHURCH,
BIRMINGHAM, ALABAMA, 9/15/63
BOMBING MATTERS

(Handwritten scribble)

(Handwritten signatures)

bc

This memorandum recommends that the Attorney General's authority be obtained to install technical surveillances on the telephones of ~~_____~~

~~_____~~

~~_____~~ are prime suspects in captioned bombing and other bombings which have taken place in Birmingham. They are also close associates of other prime suspects in these bombings.

It is hoped that through such technical surveillances, information will be developed leading to the identification of the perpetrators of the bombing of the Sixteenth Street Baptist Church in which four small Negro children were killed.

In view of the tense racial situation in Birmingham, aggravated by the recent bombings, it is believed that further activity on the part of those responsible for the bombings could easily lead to further rioting, bloodshed, loss of life, materially affecting the security of the United States.

The Birmingham Office has assured that the technical surveillances can be installed with full security. There are 60 investigative-type surveillances in operation at the present time and 14 are awaiting installation. The limit is 75.

RECOMMENDATION:

Attached is a separate memorandum concerning the installations desired. It is recommended that this memorandum be sent to the Attorney General requesting authority to install these technical surveillances.

Enclosure *clerk*
1 - Mr. Sullivan
1 - Mr. Donahue
JCT:cbm:nkr
(8)

GRH

(Handwritten circle)

REC-104

(Handwritten signatures and stamps)
157-1035-72K
DEC 9 1963

6 DEC 11 1963

Date of Mail 11-15-63

Has been removed and placed in the Special File Room of Records Branch.

Copy made by 5
for Task Force
Date 7-8-77

See File 66-2554-7530 for authority.

Subject JUNE MAIL Baybank

Removed By 35 DEC 11 1963

File Number 157-1025-722

Permanent Serial Charge Out

Subject UNKNOWN SUBJECTS: BOMBING OF SIXTEENTH STREET
BAPTIST CHURCH, BIRMINGHAM, ALABAMA, 9/15/63
BOMBING MATTERS

This serial, the original memorandum from the FBI to the Attorney General dated 11/15/63, which was returned to the Bureau signed by the Attorney General authorizing FBI to conduct electronic surveillance, has been permanently removed for retention in the National Security Electronic Surveillance File per memorandum T. J. Smith to Mr. E. S. Miller dated 7-13-73. See 62-115687-1 for details and where maintained.

*Serial 722 Declassified by 6080 on
2/28/77. LEO/rig.*

Serial 722

DECLASSIFIED BY 6080
ON 2/28/77 L EO/rig

Removed By 79 DEC 5 1975 Date _____

Complete File and Serial Number 157-1025-722

Date of Mail 11-15-63

Has been removed and placed in the Special File Room of Records Branch.

2 Copies made by CT
by Reserve Task Force
Date 1-8-79

See File 66-2554-7530 for authority.

Subject JUNE MAIL Bap Bomb

Removed By 6-DEC 1 1963

File Number 157-1025-773

Permanent Serial Charge Out

~~SECRET~~

JUNE

November 15, 1963

MEMORANDUM FOR THE ATTORNEY GENERAL

- 1 - Mr. Belmont
- 1 - Mr. Rosen
- 1 - Mr. Malley
- 1 - Mr. McGowan
- 1 - Mr. Lavin
- 1 - Mr. Sullivan
- 1 0 Mr. Donahue

UNKNOWN SUBJECTS;
 BOMBING OF SIXTEENTH STREET
 BAPTIST CHURCH, BIRMINGHAM,
 ALABAMA, SEPTEMBER 15, 1963
 BOMBING MATTERS

20c



are prime suspects and associates of suspects developed to date in the bombing of the Sixteenth Street Baptist Church.

It is requested that you authorize installation of technical surveillances at their homes or any addresses to which they may move in order that information may be developed leading to the identification of the perpetrators of the bombing, which bombing killed four small Negro children on September 15, 1963.

In view of the tense racial situation in Birmingham, further inflamed by the bombings, it is believed that additional activity on the part of those who are responsible for the bombings could easily lead to more rioting, bloodshed and loss of life, materially affecting the security of the United States.

Respectfully,

John Edgar Hoover
 Director

SENT FROM D. O.
 TIME 11:20 PM
 DATE 11-15-63
 BY *sh*

APPROPRIATE AGENCIES
 AND FIELD OFFICES
 ADVISED BY ROUTING
 SLIP(S) OF *Chal...*
 DATE 11/17/63

APPROVED _____
 DATE _____

- Tolson _____
- Belmont _____
- Mohr _____
- Casper _____
- Callahan _____
- Conrad _____
- DeLoach _____
- Evans _____
- Gale _____
- Rosen _____
- Sullivan _____
- Tavel _____
- Trotter _____
- Tele. Room _____
- Holmes _____
- Gandy _____

JCT: nkr/cag
 (11)

~~SECRET~~
 Group 1
 Excluded from automatic
 downgrading and declassification

SEE NOTE ON PAGE TWO....

DECLASSIFIED BY 6080
 ON 2/22/77 HED/CJG

MAIL ROOM TELETYPE UNIT

11 9 26 AM '63
 [Handwritten signatures and stamps]

NOTE:

See memo, Mr. Rosen to Mr. Belmont, 11/14/63, same caption, JCT/cbm.

This letter is being classified SECRET since it mentions a technical surveillance.

Declassified

Date of Mail 11-7-63

Has been removed and placed in the Special File Room of Records Branch.

1-8-79

See File 66-2554-7530 for authority.

Subject

JUNE MAIL

Bap bomb

Removed By

AL DEC 11 1963

File Number

157-1025-724

Permanent Serial Charge Out

XXXXXX
XXXXXX
XXXXXX

FEDERAL BUREAU OF INVESTIGATION FOIPA DELETED PAGE INFORMATION SHEET

4 Page(s) withheld entirely at this location in the file. One or more of the following statements, where indicated, explain this deletion.

Deleted under exemption(s) (b)(6) (b)(7)(C) (C) with no segregable material available for release to you.

Information pertained only to a third party with no reference to you or the subject of your request.

Information pertained only to a third party. Your name is listed in the title only.

Documents originated with another Government agency(ies). These documents were referred to that agency(ies) for review and direct response to you.

_____ Pages contain information furnished by another Government agency(ies). You will be advised by the FBI as to the releasability of this information following our consultation with the other agency(ies).

_____ Page(s) withheld for the following reason(s):

For your information: _____

The following number is to be used for reference regarding these pages:
157-1025-724

XXXXXX
XXXXXX
XXXXXX

XXXXXXXXXXXXXXXXXXXXX
X DELETED PAGE(S) X
X NO DUPLICATION FEE X
X FOR THIS PAGE X
XXXXXXXXXXXXXXXXXXXXX

FEDERAL BUREAU OF INVESTIGATION

REPORTING OFFICE BIRMINGHAM	OFFICE OF ORIGIN BIRMINGHAM	DATE 12/1/63	INVESTIGATIVE PERIOD 10/21 - 11/30/63
TITLE OF CASE UNKNOWN SUBJECTS; BOMBING OF 16TH STREET BAPTIST CHURCH, BIRMINGHAM, ALABAMA, 9/15/63		TYPED BY rlc	
		CHARACTER OF CASE BOMBING MATTERS	

REFERENCE: Report of SA [REDACTED] 11/15/63, Birmingham.

-P-

LEADS: An information copy is furnished Mobile because of its mutual interest in racial and bombing matters throughout the State of Alabama.

ADMINISTRATIVE:

No leads are being set out in this report inasmuch as all leads have been set out on an expedite basis and this practice will continue.

An additional copy is furnished to the Bureau in the event it is needed for dissemination.

This report includes material on stencil which had been run off as of 11/30/63 and does not intend to reflect all investigation conducted prior to 11/30/63.

APPROVED *[Signature]* SPECIAL AGENT IN CHARGE

COPIES MADE:

- 3 - Bureau (157-1025)
- 1 - Mobile (info)
- 4 - Birmingham (157-352)

1000-9/11/63

DO NOT WRITE IN SPACES BELOW

157-1025-925 REC-1

17 DEC 2 1963

10

EX-103

DISSEMINATION RECORD OF ATTACHED REPORT

AGENCY	<i>Crim Div</i>			
REQUEST RECD.				
DATE FWD.	DEC 19 1963	<i>6/26/64</i>		
HOW FWD.		<i>6-94B</i>		
BY	<i>[Signature]</i>	<i>[Signature]</i>		

NOTATIONS

[Handwritten notes and stamps]

STAT. SECT.

BH 157-352

Any reference herein to Klan, KKK, Ku Klux Klan, Knights of the Ku Klux Klan, or any similar designation shall be construed as referring to United Klans of America, Inc., Knights of the Ku Klux Klan, unless otherwise qualified.

No index is being supplied at this time but will be furnished at a later date.

Numerous negative informant contacts from auxiliary offices have been received and are included in the Birmingham file, but are not being set out in the report.

Investigation regarding the shrapnel bombing of 9/25/63; in Birmingham, relative to the clutch hub assembly piece which was found in the crime scene search, and other investigation is being incorporated in this report because all suspects are being interviewed regarding all Birmingham bombings and the inclusion of the specific material relative to the shrapnel bombing furnishes an over-all picture of investigation and eliminates duplication of reporting. It should be noted that copies of any investigation which are pertinent to a specific bombing are being channelized to those specific files.

COVER PAGE

BH 157-352
[REDACTED]

ADMINISTRATIVE

Approximately forty persons in the vicinity of Southway Grocery Center and 16th Street North and Finley Avenue were interviewed in an attempt to develop local violations against [REDACTED]

[REDACTED] The names and addresses of persons interviewed, as well as other investigation conducted along these lines, all of which was nonproductive, is set out in the case entitled [REDACTED] Racial Matters, Birmingham File 157-401.

1

BH 157-352
[REDACTED] 12

On September 22, 1963, a surveillance was initiated of the immediate area surrounding the 16th Street Baptist Church, Birmingham, Alabama. Eight teams of agents recorded license tags for a period of two hours centered about the time of the explosion that occurred the week prior. A total of 954 license tags were recorded. Of these, the same license tag was recorded by more than one team and this figure was 157 tags. The same license tag recorded by more than one team and traveling on the same street was determined to be 59.

License tags in the third group, that is, tags recorded by more than one team and not traveling on the same street, were searched through records of the Motor Vehicle Bureau, the identity of owners determined, and owners interviewed without obtaining any information pertinent to this investigation. Names were searched against members of known hate groups and suspects in this matter. Schedules reflecting the determination of repeated occurrences of the same car are maintained in this file.

D

1

BH 157-352
[REDACTED] 6290

A list of members of the 16th Street Baptist Church was obtained from [REDACTED] of the church. From this list the members that were present at the church on the morning of September 15, 1963, when the explosion occurred, was determined. These members were located and interviewed. Positive information concerning the identity of unknown subject in this matter was not obtained. However, in the course of this investigation several wide-spread rumors concerning the bombing were run down and determined to be without foundation. The list of the members of the 16th Street Baptist Church is being maintained in this file.

INFORMANTS

b2
b7D
[REDACTED] (RAC) -2 & 3 have continued to furnish information regarding the activities of [REDACTED]. These informants have also developed information relative to his contacts and associates [REDACTED].

[REDACTED] has been in touch with [REDACTED] on a regular basis and continues to be extremely conscious of FBI investigation directed towards him.

The following informants have been discontinued as set out below:

- b2* [REDACTED] (RAC) 12:10 p.m., 11/21/63
- [REDACTED] (RAC) 3:35 p.m.
- [REDACTED] (RAC) 10:20 a.m., 11/22/63
- [REDACTED] (RAC) 12:15 p.m.
- [REDACTED] (RAC) 10:30 a.m., 11/25/63
- [REDACTED] (RAC) 12:10 p.m.

The reasons for their discontinuance have been set out in a prior communication and are not being reiterated at this time.

Prior to discontinuance, these informants furnished extensive intelligence information regarding the activities of [REDACTED]

b2 [REDACTED] ROBERT E. CHAMBLISS, and NSRP headquarters.

b2
In particular, [REDACTED] (RAC) advised that members of the NSRP were jubilant over the assassination of President KENNEDY. This informant also advised that [REDACTED]

[REDACTED] (RAC) stated that ROBERT E. CHAMBLISS was happy over the death of the President.

UNITED STATES DEPARTMENT OF JUSTICE
FEDERAL BUREAU OF INVESTIGATION

22c

Copy to:

Report of:

[REDACTED]

Office:

Birmingham

Date:

12/1/63

Field Office File #:

157-352

Bureau File #:

157-1025

Title:

UNKNOWN SUBJECTS; BOMBING OF
SIXTEENTH STREET BAPTIST CHURCH,
BIRMINGHAM, ALABAMA, SEPTEMBER 15, 1963

Character:

BOMBING MATTERS

Synopsis:

[REDACTED]

Additional personal information developed
Numerous present and former klansmen in
Alabama interviewed. Background developed, but no further
positive information re captioned bombing.

[REDACTED]

Extensive investigation to determine source of dynamite to
used in 1958 attempted bombing has met with negative
results.

[REDACTED]

Efforts
to identify portion of clutch hub assembly for 1940-42 Hudson auto-
mobile continue. All projects being afforded continuous attention.
INVESTIGATION REFLECTS MANY MEMBERS OF KLAN AND SEGREGATION-TYPE
GROUPS CARRY SOME TYPE OF WEAPON. ALL SUCH INDIVIDUALS ARE,
THEREFORE, TO BE CONSIDERED ARMED AND EXTREMELY DANGEROUS.

-P-

DETAILS:

BH 157-352

TABLE OF CONTENTS

	<u>Page</u>
Neighborhood	2
Street sweepers	3
[REDACTED]	13
Prime Suspects	73
Re: T [REDACTED]	74
[REDACTED]	77
[REDACTED]	92
[REDACTED]	95
ROBERT E. CHAMBLISS	102
[REDACTED]	122
[REDACTED]	125
[REDACTED]	148
[REDACTED]	160
[REDACTED]	164
[REDACTED]	166
[REDACTED]	168
[REDACTED]	170
[REDACTED]	172
[REDACTED]	178
Eastview Klavern, UKA, Inc., KKKK	180
Investigation re Alabama KKKK and 1958 bombing	202
Tuscaloosa, Alabama, area klansmen	249
Investigation re klansmen and church burning, Warrior, Alabama	280
Other klansmen	324
Dixie Klans, KKKK, Inc., Gadsden, Alabama	361
National States Rights Party	370
Miscellaneous	373

NEIGHBORHOOD

PRIME SUSPECTS

BH 157-352
[REDACTED]

67c
On October 30, 1963, a piece of coat hanger wire was found by SA [REDACTED] in a junk pile located just outside the workshop of [REDACTED]. This workshop is located behind the residence at [REDACTED] Alabama. This piece of wire was submitted to the FBI Laboratory for comparison with material previously forwarded from evidence located at the scene of the explosion in the vicinity of 1601 South Center Street, Birmingham, Alabama, September 25, 1963.

On November 22, 1963, the FBI Laboratory advised as follows:

A comparison of specimen K27 with the previously submitted Q17 portion of a wire coat hanger disclosed that they are not pieces of the same coat hanger. The beginning of the hook part of the hanger is present on Q17 and since it is also present on K27 the latter specimen could not be part of specimen Q17.

The cut ends of the K27 wire were cut with a similar type tool to the tool used to cut the Q17 wire. However, the cut ends of K27 are rusted which prevents a determination as to whether or not the same tool was used to cut these two specimens.

EASTVIEW KLAVERN, UKA, INC., KKKK

INVESTIGATION REGARDING ALABAMA KKKK AND 1958 BOMBING

TUSCALOOSA, ALABAMA, AREA KLANSMEN

INVESTIGATION RE KLANSMEN
AND CHURCH BURNING
WARRIOR, ALABAMA

OTHER KLANSMEN

DIXIE KLANS, KKKK, INC.,
GADSDEN, ALABAMA

361

NATIONAL STATES RIGHTS PARTY

MISCELLANEOUS

0

373

1

BH 157-407
BH 157-352

b2 [REDACTED]

On November 1, 1963, two fragments of what appeared to have once been one or more beer cans, which were located in the vicinity of the explosion of the shrapnel bomb on September 25, 1963, in the vicinity of 1601 Center Street South, Birmingham, Alabama, were sent to the FBI Laboratory to be examined for any residue which could be either sulfuric or muriatic acid or for potassium chlorate.

On November 8, 1963, the FBI Laboratory advised as follows:

Specimens received 11/4/63

Q18 - Q 19 Two metal fragments

Results of examination:

No residues were recovered from the metal fragments, Q18 and Q19, which could be associated with the residues from an explosive, fuse or chemical delay device.

370

1

BH 157-352
[REDACTED]

During investigation to locate a portion of a 1940 - 1942 Hudson clutch hub assembly, junk yards and automobile salvage places have been searched in the following areas in Birmingham:

hsc

[REDACTED]

In addition to the above, all suspects or acquaintances who have anything to do with auto parts places or garages have been questioned concerning the Hudson clutch hub assembly with negative results.

XXXXXX
XXXXXX
XXXXXX

FEDERAL BUREAU OF INVESTIGATION
FOIPA DELETED PAGE INFORMATION SHEET

401

Page(s) withheld entirely at this location in the file. One or more of the following statements, where indicated, explain this deletion.

- Deleted under exemption(s) (b)(2), (b)(7)(C), (D) with no segregable material available for release to you.
- Information pertained only to a third party with no reference to you or the subject of your request.
- Information pertained only to a third party. Your name is listed in the title only.
- Documents originated with another Government agency(ies). These documents were referred to that agency(ies) for review and direct response to you.

_____ Pages contain information furnished by another Government agency(ies). You will be advised by the FBI as to the releasability of this information following our consultation with the other agency(ies).

_____ Page(s) withheld for the following reason(s):

For your information: _____

The following number is to be used for reference regarding these pages:
157-1025-725

XXXXXX
XXXXXX
XXXXXX

XXXXXXXXXXXXXXXXXXXXX
X DELETED PAGE(S) X
X NO DUPLICATION FEE X
X FOR THIS PAGE X
XXXXXXXXXXXXXXXXXXXXX

*NA
12/6
Jed*

FEDERAL BUREAU OF INVESTIGATION
U. S. DEPARTMENT OF JUSTICE
COMMUNICATIONS SECTION

DEC 6 1963

TELETYPE

Mr. Tolson	_____
Mr. Belmont	_____
Mr. Mohr	_____
Mr. Casper	_____
Mr. Callahan	_____
Mr. Conrad	_____
Mr. DeLoach	_____
Mr. Evans	_____
Mr. Gale	_____
Mr. Rosen	_____
Mr. Sullivan	_____
Mr. Tavel	_____
Mr. Trotter	_____
Tele. Room	_____
Miss Holmes	_____
Miss Gandy	_____

lu

URGENT 12-6-63 7-04 PM CST HEP
TO DIRECTOR /157-1025/
FROM SAC BIRMINGHAM /157-352/ 3P

BAPBOMB.

DAILY SUMMARY.

RE CHAMBLISS GROUP.

SAC, ASAC, AND CERTAIN BIRMINGHAM AGENTS WORKING ON THIS PHASE
OF INVESTIGATION AT CONFERENCE WITH [REDACTED]

67C10

[REDACTED]

END PAGE ONE

F227

58 DEC 12 1963

EX-115
REC 30

*Thomson
Belmont
12/7/63
J2/ace*

157-1025-726

11 DEC 9 1963

6-111

XXXXXX
XXXXXX
XXXXXX

FEDERAL BUREAU OF INVESTIGATION FOIPA DELETED PAGE INFORMATION SHEET

 1 Page(s) withheld entirely at this location in the file. One or more of the following statements, where indicated, explain this deletion.

Deleted under exemption(s) (b)(7)(C) and (D) with no segregable material available for release to you.

Information pertained only to a third party with no reference to you or the subject of your request.

Information pertained only to a third party. Your name is listed in the title only.

Documents originated with another Government agency(ies). These documents were referred to that agency(ies) for review and direct response to you.

 Pages contain information furnished by another Government agency(ies). You will be advised by the FBI as to the releasability of this information following our consultation with the other agency(ies).

 Page(s) withheld for the following reason(s):

For your information: _____

The following number is to be used for reference regarding these pages:
157-1025-726 p2

XXXXXX
XXXXXX
XXXXXX

XXXXXXXXXXXXXXXXXXXXX
X DELETED PAGE(S) X
X NO DUPLICATION FEE X
X FOR THIS PAGE X
XXXXXXXXXXXXXXXXXXXXX

PAGE THREE.

[REDACTED]

b2c
10

THIRTYFIVE INTERVIEWS CONDUCTED. ABOUT SIXTY PENDING.

END

8-14 PM OK FBI WA WS

TU CLR

DEC 8 8 14 AM '68

FBI
REC'D IN THE OFFICE

- Tolson _____
- Belmont _____
- Mohr _____
- Casper _____
- Callahan _____
- Conrad _____
- DeLoach _____
- Evans _____
- Gale _____
- Rosen _____
- Sullivan _____
- Tavel _____
- Trotter _____
- Tele. Room _____
- Holmes _____
- Gandy _____

DECODED COPY

AIRGRAM CABLEGRAM RADIO TELETYPE

URGENT 12-6-63
 TO DIRECTOR
 FROM SAC BIRMINGHAM 061945

BAPBOMB

ALL AGENTS IN BIRMINGHAM ON SPECIAL ASSIGNMENT BEING RELEASED THIS WEEK WITH EXCEPTION OF SA [REDACTED] WHO IS HANDLING LIAISON ASSIGNMENT WITH SHERIFF'S OFFICE AND IT IS CONSIDERED FEASIBLE TO HOLD HIM UNTIL DECEMBER 11, NEXT, TO FACILITATE COMPLETION OF TRANSITION STAGE IN ONE PHASE OF THE INVESTIGATION.

DETAILS CONCERNING RELEASE OF OTHER PERSONNEL THIS WEEK BEING FURNISHED BY SEPARATE COMMUNICATION.

RECEIVED 3:24 PM MAD

REC-86

157-1075-727

6 DEC 9 1963

ST-105

DEC 8 2 55 PM '63

DEPARTMENT OF JUSTICE
FBI

FBI
REC'D - CIA RIGHTS

CC-Movement 3 28 PM '63

DEC 8 4 55 PM '63

59 DEC 11 1963

TELETYPE UNIT
RECEIVED

FBI
REC'D - BIRMINGHAM

UNITED STATES GOVERNMENT

Memorandum

TO : Mr. Belmont

DATE: December 6, 1963

FROM : A. Rosen

SUBJECT: UNKNOWN SUBJECTS
BOMBING OF SIXTEENTH
STREET BAPTIST CHURCH
BIRMINGHAM, ALABAMA
SEPTEMBER 15, 1963
BOMBING MATTERS

Tolson	✓
DeLoach	✓
Mohr	✓
Casper	✓
Callahan	✓
Conrad	✓
DeLoach	✓
Evans	✓
Gale	✓
Rosen	✓
Sullivan	✓
Tavel	✓
Trotter	✓
Tele. Room	✓
Holmes	✓
Gandy	✓

Bopbomb

Leff

Jerry Dutton, an official of the National States Rights Party (NSRP), an anti-Negro and anti-Semitic group with headquarters in Birmingham, was tried in Birmingham City Recorder's Court on 12/5/63 for having made a fictitious complaint to the Birmingham Police Department on 10/30/63. He was fined \$50 and sentenced to 60 days in jail. The jail sentence was suspended.

Alabama

The incident involving Dutton occurred at NSRP headquarters in Birmingham when Dutton called the police department alleging that Bureau Agents were communists and trespassers although the Agents had identified themselves as Agents there on official business. An officer of the police department testified the false call resulted in six cars of the department answering the call. Special Agents [redacted] and [redacted] appeared as state witnesses.

9

Dutton's attorney Matt Murphy who is also the attorney for other members of the NSRP presently under indictment in Federal court for interfering with the desegregation of Birmingham schools, has made the necessary arrangements to appeal Dutton's conviction.

[redacted] arrived on 12/5/63 in Birmingham from Atlanta, Georgia, where he resides. His activities will be carefully watched.

- 1 - Mr. Mohr
- 1 - Mr. DeLoach
- 1 - Mr. Evans

RBL:pab
(9)

REC 7 157-1075-728

DEC 9 2 52 PM '63 12 DEC 9 1963

EX-115

53 DEC 12 1963

F-229

6-11
PERS. REC. UNIT

Memorandum to Mr. Belmont
RE: BOMBING OF SIXTEENTH
STREET BAPTIST CHURCH

Numerous interviews were conducted yesterday concerning the bombing cases with no additional pertinent information being developed.

ACTION:

You will be kept advised of developments.

Q *Alvin* *V. Keene* *RM* *Ry*

UNITED STATES GOVERNMENT

Memorandum

Tolson	_____
Belmont	_____
Mohr	_____
Casper	_____
Callahan	_____
Conrad	_____
DeLoach	_____
Evans	_____
Gale	_____
Rosen	_____
Sullivan	_____
Tavel	_____
Trotter	_____
Tele. Room	_____
Holmes	_____
Gandy	_____

TO : Mr. Belmont *also*

DATE: December 5, 1963

FROM : A. Rosen *Rosen*

SUBJECT: UNKNOWN SUBJECTS
 BOMBING OF SIXTEENTH
 STREET BAPTIST CHURCH
 BIRMINGHAM, ALABAMA
 SEPTEMBER 15, 1963
 BOMBING MATTERS

BAP Bomb

Larson

It was mentioned in my memorandum yesterday that D. R. Hays, Superintendent of Camp Childersburg, Alabama, a prison camp, had received instructions from Attorney Charles Reynolds of the Legal Section of the Alabama Highway Patrol that convicts were not to be made available for interview by the FBI without a court order.

On 12/4/63 Reynolds advised the Mobile Office there must have been a misunderstanding at Camp Childersburg and Reynolds assured the Mobile Office that his department desires to cooperate with the FBI in matters of mutual interest and suggested recontact by the FBI at Camp Childersburg.

Reynolds assured the Mobile Office he would send letters to all superintendents of prison camps in the State of Alabama instructing that the FBI be permitted to interview prisoners and officials in civil rights matters. Reynolds did request that as much advance notice be given to insure availability of prisoners for interview, as possible.

[REDACTED SECTION]

- 1 - Mr. Mohr
- 1 - Mr. DeLoach
- 1 - Mr. Evans

RBL:pab *pab*
(9)

60 DEC 11 1963

EX-108 REC-40

157-1025-129

25 DEC 9 1963

[Handwritten signature]

Memorandum to Mr. Belmont
RE: BOMBING OF SIXTEENTH
STREET BAPTIST CHURCH

67-119
[REDACTED]
[REDACTED] locate these two men and the car.

Efforts are continuing to

[REDACTED] was reinterviewed on 12/4/63 but
no pertinent information was received.

Spot checks of prime suspects at their residences and
places of employment were made yesterday without any unusual
activity being noted.

ACTION:

You will be kept advised of developments.

Q
[Signature]
Rg.
[Signature]
[Signature]

XXXXXX
XXXXXX
XXXXXX

FEDERAL BUREAU OF INVESTIGATION
FOIPA DELETED PAGE INFORMATION SHEET

6 Page(s) withheld entirely at this location in the file. One or more of the following statements, where indicated, explain this deletion.

Deleted under exemption(s) (b)(7)(C) and (D) with no segregable material available for release to you.

Information pertained only to a third party with no reference to you or the subject of your request.

Information pertained only to a third party. Your name is listed in the title only.

Documents originated with another Government agency(ies). These documents were referred to that agency(ies) for review and direct response to you.

_____ Pages contain information furnished by another Government agency(ies). You will be advised by the FBI as to the releasability of this information following our consultation with the other agency(ies).

_____ Page(s) withheld for the following reason(s):

For your information: _____ 0

The following number is to be used for reference regarding these pages:
157-1025-NR 5V antel dtd 10-4-63

XXXXXX
XXXXXX
XXXXXX

XXXXXXXXXXXXXXXXXXXXX
X DELETED PAGE(S) X
X NO DUPLICATION FEE X
X FOR THIS PAGE X
XXXXXXXXXXXXXXXXXXXXX

FEDERAL BUREAU OF INVESTIGATION
U. S. DEPARTMENT OF JUSTICE
COMMUNICATIONS SECTION

DEC 9 1963

TELETYPE

Mr. Tolson	_____
Mr. Belmont	_____
Mr. Mohr	_____
Mr. Casper	_____
Mr. Callahan	_____
Mr. Conrad	_____
Mr. DeLoach	_____
Mr. Evans	_____
Mr. Gale	_____
Mr. Rosen	_____
Mr. Sullivan	_____
Mr. Tavel	_____
Mr. Trotter	_____
Tele. Room	_____
Miss Holmes	_____
Miss Gandy	_____

URGENT 12-9-63 7-43 PM CST GDM
TO DIRECTOR
FROM SAC, BIRMINGHAM /157-352/ 2P

McGowan

BAPBOMB DAILY SUMMARY.
PHYSICAL SURVEILLANCE
SPOT FISUR CONDUCTED ON RESIDENCES OVER WEEKEND WITHOUT NOTING ANY UNUSUAL ACTIVITY. DETERMINED THAT SUSPECT [REDACTED] THROUGHOUT SUNDAY AFTERNOON ASSISTED CIVILIAN DEFENSE IN HANDLING SABIN ORAL / VACCINE PROGRAM AT A LOCAL SCHOOL.

PHYSICAL SURVEILLANCE
FROM FISUR EARLY TODAY ON SUSPECT [REDACTED] ASCER-
TAINED THAT HE HAS NOW SECURED EMPLOYMENT IN [REDACTED]
[REDACTED] A BIRMINGHAM SUBURB.

[REDACTED]

67c 12

EX-102 REC-22

157-1025-736

DEC 11 1963

END PAGE ONE

*Open to Belmont
61 DEC 13 12/10/63
PJM: Tade*

cc: Lavin

REC'D 8 25 48
FBI
REC'D 8 25 48

47-48

PAGE TWO

[REDACTED]

TWENTY EIGHT INTERVIEWS CONDUCTED. FIFTY SEVEN REMAINING.

END AND ACK

WA 8-48 PM OK FBI WA RL

FEDERAL BUREAU OF INVESTIGATION
U. S. DEPARTMENT OF JUSTICE
COMMUNICATIONS SECTION

DEC 8 1963

TELETYPE

Mr. Tolson	_____
Mr. Belmont	_____
Mr. Mohr	_____
Mr. Casper	_____
Mr. Callahan	_____
Mr. Conrad	_____
Mr. DeLoach	_____
Mr. Evans	_____
Mr. Gale	_____
Mr. Rosen	_____
Mr. Sullivan	_____
Mr. Tavel	_____
Mr. Trotter	_____
Tele. Room	_____
Miss Holmes	_____
Miss Gandy	_____

*2a
12/8/63
9:10 PM
M*

McGowan *Jarvis*

URGENT 12-8-63 7-42 PM CST HEP
TO DIRECTOR /157-1025/
FROM SAC BIRMINGHAM /157-352/ 4P

BAPBOMB.

DAILY SIMMARY.

67D

[REDACTED]

REC-46 157-1025-1025

END PAGE ONE

8 DEC 11 1963

*Rosen to Belmont memo
12/9/63 PJM: [unclear]*

EX-10

cc: *Jarvis*

6

XXXXXX
XXXXXX
XXXXXX

FEDERAL BUREAU OF INVESTIGATION
FOIPA DELETED PAGE INFORMATION SHEET

1 Page(s) withheld entirely at this location in the file. One or more of the following statements, where indicated, explain this deletion.

Deleted under exemption(s) b7C and D with no segregable material available for release to you.

Information pertained only to a third party with no reference to you or the subject of your request.

Information pertained only to a third party. Your name is listed in the title only.

Documents originated with another Government agency(ies). These documents were referred to that agency(ies) for review and direct response to you.

_____ Pages contain information furnished by another Government agency(ies). You will be advised by the FBI as to the releasability of this information following our consultation with the other agency(ies).

_____ Page(s) withheld for the following reason(s):

For your information: _____

The following number is to be used for reference regarding these pages:

157-1085-731 p2

XXXXXX
XXXXXX
XXXXXX

XXXXXXXXXXXXXXXXXXXXX
X DELETED PAGE(S) X
X NO DUPLICATION FEE X
X FOR THIS PAGE X
XXXXXXXXXXXXXXXXXXXXX

PAGE THREE.

[REDACTED]

IT WAS PREVIOUSLY REPORTED THAT THOMAS E. BLANTON, SR., VISITED WEST END BRANCH, FIRST NATIONAL BANK OF BIRMINGHAM, THIS PAST WEEK.

[REDACTED]

TAMPA DIVISION HAS BEEN REQUESTED TO DETERMINE DETAILS RE THIS AS NO PREVIOUS INFORMATION CONCERNING PROPERTY HELD BY BLANTON IN THAT AREA.

[REDACTED]

SPOT CHECKS OF PRINCIPAL SUSPECTS MADE AND NO PERTINENT DEVELOPMENTS.

END PAGE THREE.

PAGE FOUR.

SIX INTERVIEWS CONDUCTED AND ABOUT SIXTYTHREE PENDING.

END

8-54 PM OK FBI WA OS

CLR

DEC 9 8 24 53
REC'D
FBI
REC'D IN FILE RMU

Mr. Gorman July 7/63

THIS IS FBI WA 202-965-0711

FEDERAL BUREAU OF INVESTIGATION
U. S. DEPARTMENT OF JUSTICE
COMMUNICATIONS SECTION

DEC 7 1963

TELETYPE

Mr. Tolson	
Mr. Belmont	
Mr. Mohr	
Mr. Casper	
Mr. Callahan	
Mr. Conrad	
Mr. DeLoach	
Mr. Evans	
Mr. Gale	
Mr. Rosen	<i>[initials]</i>
Mr. Sullivan	
Mr. Tavel	
Mr. Trotter	
Tele. Room	
Miss Holmes	
Miss Gandy	

Ward
St. Johnston
1
4

URGENT 12-7-63 6-15 PM CST HEP
TO DIRECTOR /157-1025/
FROM SAC BIRMINGHAM /157-352/ 4P

BAPBOMB
DAILY SUMMARY.

[REDACTED]

END PAGE ONE

58 D/C 11/9/63
Rosen to Belmont
PJM:tel

REC-20 / 157-1025-733
EX-112
DEC 11 1963
ee-Levin
6

PAGE TWO.

[REDACTED]

THIS WILL BE FOLLOWED INCLUDING DETAILS OF ARREST AND
POSSIBILITY THAT [REDACTED] MAY AT THIS TIME BE RECEPTIVE TO
INTERVIEW AND POSSIBLY FURNISH INFORMATION.

[REDACTED]

[REDACTED]

END PAGE TWO.

ALF

0120

ALA

ALA

ALA

XXXXXX
XXXXXX
XXXXXX

FEDERAL BUREAU OF INVESTIGATION FOIPA DELETED PAGE INFORMATION SHEET

1 Page(s) withheld entirely at this location in the file. One or more of the following statements, where indicated, explain this deletion.

Deleted under exemption(s) (b)(7)(C) and (b)(7)(D) with no segregable material available for release to you.

Information pertained only to a third party with no reference to you or the subject of your request.

Information pertained only to a third party. Your name is listed in the title only.

Documents originated with another Government agency(ies). These documents were referred to that agency(ies) for review and direct response to you.

_____ Pages contain information furnished by another Government agency(ies). You will be advised by the FBI as to the releasability of this information following our consultation with the other agency(ies).

_____ Page(s) withheld for the following reason(s):

For your information: _____

The following number is to be used for reference regarding these pages:

157-1085-723 P3

XXXXXX
XXXXXX
XXXXXX

XXXXXXXXXXXXXXXXXXXXX
X DELETED PAGE(S) X
X NO DUPLICATION FEE X
X FOR THIS PAGE X
XXXXXXXXXXXXXXXXXXXXX

PAGE FOUR.

A MEETING OF EASTVIEW KLAVERN WILL BE HELD ON THURSDAY
DECEMBER TWELVE, SIXTYTHREE, AT WHICH TIME AN ELECTION OF OFFICERS
WILL BE HELD. [REDACTED] EXPECTS A GOOD TURNOUT.

67c
12 TWELVE INTERVIEWS CONDUCTED AND ABOUT SIXTYFIVE PENDING.
SPOT CHECK FISURS NOT PRODUCTIVE.

END

K 7-27 PM OK FBI WA WS

TU

DEC 12 1963
FBI - WASHINGTON

DEC 12 1963

UNITED STATES GOVERNMENT

Memorandum

Viper

- Tolson
- Belmont
- Mohr
- Casper
- Callahan
- Conrad
- DeLoach
- Evans
- Gale
- Rosen
- Sullivan
- Tavel
- Trotter
- Tele. Room
- Holmes
- Gandy

TO : Mr. Belmont *aw*

DATE: December 7, 1963

FROM : A. Rosen

SUBJECT: UNKNOWN SUBJECTS;
BOMBING OF SIXTEENTH
STREET BAPTIST CHURCH
BIRMINGHAM, ALABAMA
SEPTEMBER 15, 1963
BOMBING MATTERS

on file

[REDACTED]

100
[REDACTED]

[REDACTED]

- 1 - Mr. Mohr
- 1 - Mr. DeLoach
- 1 - Mr. Evans

REC- 52

JCT: cac
(9) *cac*

EX-114

157-1025-734

25 DEC 11 1963

57 DEC 16 1963

6

Memorandum to Mr. Belmont
RE: UNKNOWN SUBJECTS; BOMBING OF
SIXTEENTH STREET BAPTIST CHURCH

b7c id

[REDACTED]

[REDACTED]

We are continuing to develop all information received concerning Robert Chambliss and [REDACTED] as well as other members of the Chambliss group who are prime suspects in this case.

b7c

ACTION

You will be kept advised of developments.

to
lcm/jat
R
V. Kennedy

FEDERAL BUREAU OF INVESTIGATION

Reporting Office KNOXVILLE	Office of Origin BIRMINGHAM	Date 11/19/63	Investigative Period 9/15/63 - 11/14/63
TITLE OF CASE UNKNOWN SUBJECTS; BOMBING OF 16th STREET BAPTIST CHURCH, BIRMINGHAM, ALABAMA, SEPTEMBER 15, 1963		Report made by <div style="background-color: black; width: 100px; height: 15px;"></div>	Typed CYP
		CHARACTER OF CASE BOMBING MATTERS	

REFERENCES: Birmingham teletype to Bureau, Atlanta, Knoxville, Jacksonville, Tampa, Memphis, Mobile, New Orleans, and Savannah 9/15/63.
 Bureau teletype to Southeastern Offices 9/15/63.
 Knoxville teletypes to Bureau 9/16/63 and 9/18/63.
 Bureau teletype to Knoxville 9/20/63.
 Knoxville airtel to Bureau 9/21/63.
 Birmingham teletype to Bureau 9/25/63.
 Knoxville teletype to Bureau 9/25/63.
 Knoxville teletype to Birmingham 9/26/63. (IO)
 Birmingham teletype to Knoxville 9/26/63. (IO)
 Birmingham airtel to Knoxville 10/4/63. (IO)
 Knoxville airtel to Bureau 10/8/63.
 Knoxville airtel to Birmingham 10/10/63. (IO)
 Knoxville teletype to Bureau 10/21/63.
 Bureau radiogram to Knoxville 10/22/63.
 Knoxville airtels to Bureau 11/4/63 and 11/5/63.
 Birmingham airtel to Knoxville 10/27/73. (IO)
 Bureau airtel to Knoxville 10/25/63.

EX-110

Approved <i>[Signature]</i>	Special Agent in Charge	Do not write in spaces below
Copies made: 5 - Bureau (157-1025) (RM) 3 - Birmingham (157-352) (RM) 1 - Atlanta (157-582) (RM) (Info) 1 - Miami <div style="background-color: black; width: 50px; height: 10px;"></div> (Info) (RM) <i>670</i> 5 - Knoxville (2 - 157-189) <i>670</i> (1 - 157-13) (1 - 157-68) (1 - 157-79)		<div style="font-size: 2em; font-weight: bold;">157-1025-735</div> <div style="border: 1px solid black; padding: 5px; display: inline-block;"> 12-12 11 NOV 21 1963 </div>

*1cc - Orig Unit
Civil Div
6/26/64
6-94B*

KX 157-189

ADMINISTRATIVE

One extra copy of this report is being submitted to the Birmingham Division in case it later develops that one copy is needed for USA, Birmingham.

One copy of this report is being submitted to Atlanta for information in view of the investigation this case, and one copy being submitted for Miami Division in view of reported activities by Miami informant relating to this case.

Knoxville airtels to Bureau 9/21/63 and 10/8/63 set forth results of investigation, Knoxville Division, regarding bomb suspects, Knoxville Division, reporting information regarding their past and present activities and reported position re acts of violence. Results of interviews with them, as well as members of klan-type and hate-type organizations, Knoxville Division, all met with negative results.

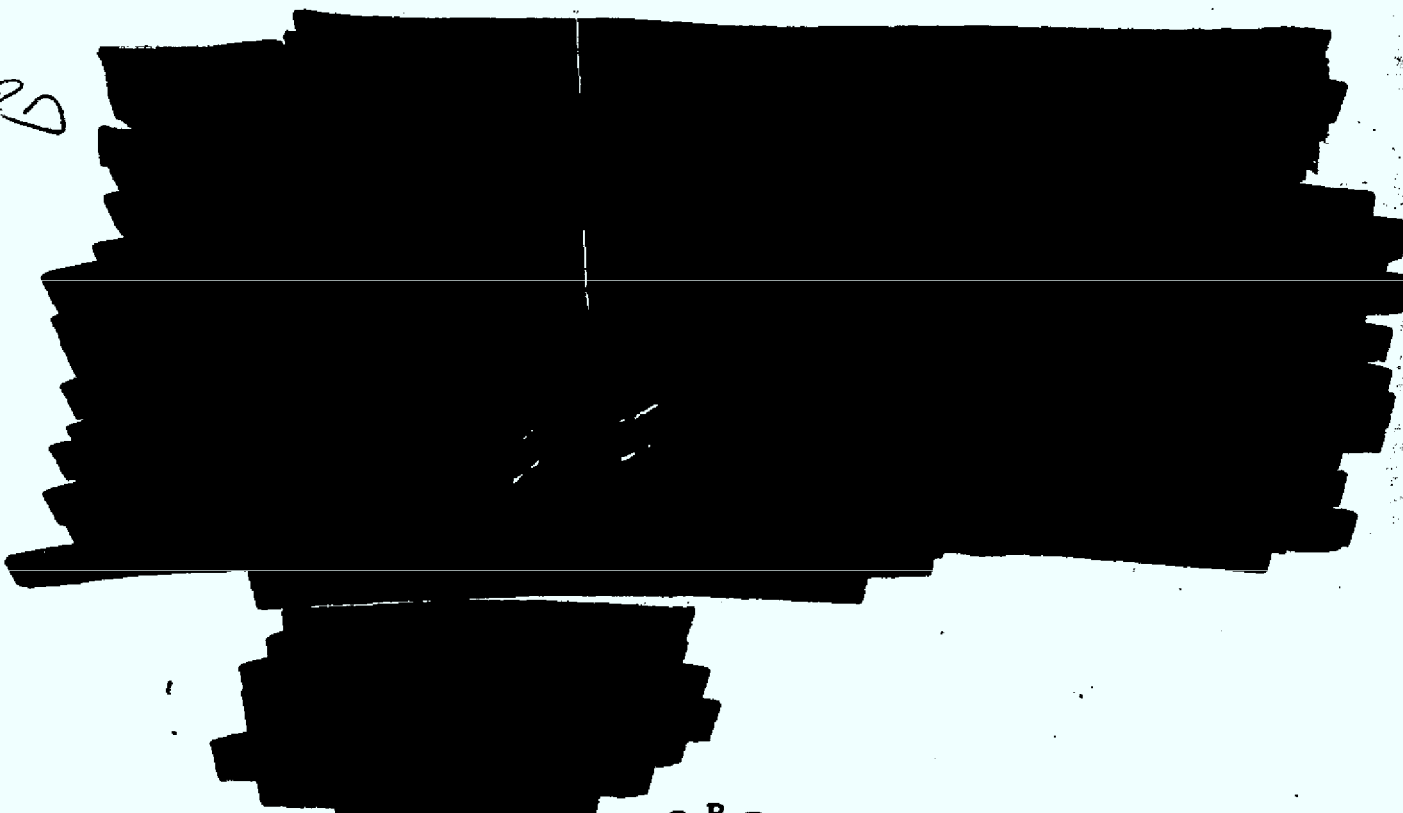

KX 157-189

62



Knoxville, by communication dated 11/4/63 to the Bureau, submitted to the Birmingham Division photographs of [redacted] together with color photographs of cars known to be available to these individuals.

By communication dated 11/5/63, the Knoxville Division furnished the FBI Identification Division with information regarding the above three individuals, with others, to assist in locating fingerprints of these individuals to be searched and compared against the latent fingerprint recovered in connection with the attempted bombing of the Jewish Temple Bethel, Birmingham, Alabama, April 28, 1958.

LEADS

All leads, this case, have been received through detailed airtel and other separate communications. When covered, the results of the investigation, Knoxville Division, has been furnished to the Bureau and Birmingham Division by separate communications; therefore, no leads are being set forth in this report.

- F* -

COVER PAGE

UNITED STATES DEPARTMENT OF JUSTICE
FEDERAL BUREAU OF INVESTIGATION

Copy to: *675*

Report of: [REDACTED]

Office: KNOXVILLE

Date: 11/19/63

File Number: 157-189

Bureau file: 157-1025

Title: UNKNOWN SUBJECTS; BOMBING OF
16th STREET BAPTIST CHURCH,
BIRMINGHAM, ALABAMA, SEPTEMBER 15, 1963

Character: BOMBING MATTERS

675
Synopsis: [REDACTED]

All three of the above individuals determined through investigation to have been in Chattanooga, Tennessee, on September 15, 1963. No information developed any of the three individuals have associated with individuals from State of Alabama or that they have visited with individuals in Alabama or have been visited by individuals from Alabama within the past several months. Background information re recent activities of these individuals set forth.

- P -

DETAILS: AT CHATTANOOGA, TENNESSEE:

Date September 30, 1963

Special Agent [redacted] personally observed between 7:45 AM and 8:15 AM, September 25, 1963, [redacted] at his place of employment, [redacted]

[redacted] Chattanooga, Tennessee. At this time his 1951 Ford half-ton pickup truck, dark green in color, bearing 1963 Tennessee license [redacted] was observed parked at this place of business.

At 8:10 AM, September 25, 1963, Special Agent [redacted] observed a 1957 Ford, 2-door, green and white, bearing 1962 Tennessee license [redacted] which is the property of [redacted] parked at the [redacted] residence, [redacted] Chattanooga, Tennessee. Also parked at this address was a 1951 Chevrolet Club Coupe, bearing 1962 Tennessee license [redacted] which is registered to [redacted] and has been used in the past by [redacted] however, during spot checks of this residence for the past two weeks, this car has had one flat tire and does not appear to now be in use by the [redacted] family.

At 8:15 AM, September 25, 1963, the above-described 1957 Ford had been moved and was not located at this address.

On 9/25/63 at Chattanooga, Tennessee File # KX 157-189
by Special Agent [redacted] Date dictated 9/26/63

This document contains neither recommendations nor conclusions of the FBI. It is the property of the FBI and is loaned to your agency; it and its contents are not to be distributed outside your agency.

On October 29 and 30, 1963, Special Agent [redacted] took color photographs of the following automobiles, Chattanooga, Tennessee:

10/29/63 1957 Ford, 2-door, green and white, property of [redacted] bearing 1962 Tennessee license [redacted]. This car was parked at the parking lot of [redacted] Chattanooga, Tennessee. (4 photographs)

10/29/63 1951 Ford one-half ton pickup truck, dark green, 1963 Tennessee license [redacted] registered to [redacted] name [redacted] photographed at above address. (1 photo)

67c

10/29/63 1958 Ford, 2-door, tan and white, 1962 Tennessee license [redacted] registered to [redacted] who is now wife of [redacted] Photographed beside East Chattanooga Fire Hall. (4 photographs)

10/30/63 1959 Ford, 2-door, green and white, property of [redacted] Photographed at [redacted] parking lot. (7 photos) This car bore 1962 Tennessee license # [redacted]

10/30/63 1955 Oldsmobile "88", 2-door, white and orange, bearing 1963 Alabama license [redacted] photographed [redacted] (1 photograph)

10/30/63 1957 Dodge, two-tone blue, 2-door, property of [redacted] Photographed rear yard of [redacted] residence, [redacted] This car bore 1962 Tennessee license [redacted] (1 photograph)

The above 1951 Ford pickup truck was observed on October 29, 30, and 31, 1963, by Special Agent [redacted]

On 10/29,30,31/63 at Chattanooga, Tennessee File # KX 157-189

67c

by Special Agent [redacted] cyp Date dictated 10/31/63

KX 157-189

at various times in East Chattanooga, Tennessee, at 1911 Wilder Avenue, 2915 Taylor Street, and other locations in East Chattanooga.

On October 29, 1963, the 1955 Oldsmobile "88", 2-door, described above, was observed parked the majority of the day directly in front of the [REDACTED]

[REDACTED] and on numerous occasions [REDACTED] father-in-law of [REDACTED] was observed working on this car. It was again parked in the same location on October 30, 1963, and did not appear to have been moved from 12:35 PM to 5:30 PM, October 30, 1963. Again, on several occasions [REDACTED] appeared to be working or rubbing on this car. On this date the license number was obtained, which was reported as 1963 Alabama license [REDACTED]. This car was again observed parked same location on October 31, 1963.

On the afternoon of October 30, 1963, Special Agent [REDACTED] observed an unknown woman driving 1955 Oldsmobile, 4-door, bearing 1962 Tennessee license [REDACTED] drive up to the side of [REDACTED] let out two boys approximate ages 8 and 11, then drive away from this address.

On the afternoon of October 30, 1963, two other automobiles in addition to those listed above were observed at [REDACTED] Chattanooga, Tennessee. These two are described as:

1953 Dodge, 4-door, white, bearing 1962 Tennessee license [REDACTED] registered to [REDACTED] Chattanooga, Tennessee; and

1960 Cadillac Coupe, 1962 Tennessee license [REDACTED] registered to [REDACTED] Chattanooga, Tennessee.

On October 31, 1963, Special Agent [REDACTED] observed parked at [REDACTED] a 1961 Oldsmobile "88", 4-door, 1962 Tennessee license [REDACTED] registered to [REDACTED] Chattanooga, Tennessee.

KX 157-189

[REDACTED]

b7c, d

By communication dated November 14, 1963, Birmingham Division furnished the following information:

On November 12, 1963, Special Agent [REDACTED] checked the automobile registration records, Fort Payne, Alabama, which records reflect that Alabama license [REDACTED] is registered to [REDACTED] Georgia (DeKalb County, Alabama), for a 1955 Oldsmobile, Identification [REDACTED]

b7c, d

Investigation, DeKalb County, Alabama, reflects that [REDACTED] employed by [REDACTED] Chattanooga, Tennessee.

[REDACTED]

An article appeared in the Chattanooga News Free Press, Chattanooga, Tennessee, October 21, 1963, reflecting that J. A. MILTEER appeared at a Constitutional Party Convention scheduled at Indianapolis, Indiana. MILTEER had declared himself a Regional Chairman for the Southeastern States, reported was from Quitman, Georgia, and drove to that meeting in a truck plastered with signs advocating Senator J. STROM THURMAN, nominee for President.

Date October 30, 1963

At 6:05 PM, October 21, 1963, there was observed in the parking lot of the [redacted] located on [redacted] Chattanooga, Tennessee, operated by [redacted] a Volkswagen vehicle bearing 1963 Georgia license [redacted] or possibly [redacted]. This vehicle was either a truck or station wagon but as the sides were completely covered with signs it was not possible to tell definitely. The signs reflected the name of STROM THURMOND for President.

Also parked on this lot was a 1957 Ford pickup truck, green in color, similar to the truck driven by [redacted] in the past.

The machine shop appeared to open, however, no one was observed.

The Volkswagen vehicle was not observed later in the evening, either at the shop or at the residence of [redacted]

On 10/21/63 at Chattanooga, Tennessee File # KX 157-189
by Special Agent [redacted] :CYD Date dictated 10/25/63

This document contains neither recommendations nor conclusions of the FBI. It is the property of the FBI and is loaned to your agency; it and its contents are not to be distributed outside your agency.

KX 157-189

By telephone, the Birmingham Division advised the Knoxville Division at 2:15 AM, September 5, 1963, that unknown subjects had bombed the residence of ARTHUR SHORES, Birmingham, Alabama, on the night of September 4, 1963.

At 2:30 AM, September 5, 1963, Special Agent [redacted] observed the residence of [redacted] and [redacted] Chattanooga, Tennessee. All cars known to have been available for their use, including 1957 Chevrolet, 2-door, bearing 1962 Tennessee license [redacted] and 1957 Ford, 2-door, bearing 1962 Tennessee license [redacted] and 1951 Ford pick-up truck, bearing 1963 Tennessee license [redacted] were observed parked at this residence.

[redacted] was observed by Special Agent [redacted] between 7:30 and 8:00 AM, September 5, 1963, at his place of employment, [redacted] Chattanooga, Tennessee.

[redacted]

[redacted]

D

Date September 20, 1963

b7c

Special Agent [redacted] spot checked the residence of [redacted] Chattanooga, Tennessee, between 4:00 and 4:30 PM, September 15, 1963. At that time [redacted] 1957 Ford, two-tone green, 2-door, bearing 1962 Tennessee license [redacted] could not be located by Special Agent [redacted]. Parked at this residence at the dead-end of [redacted] was approximately a 1954 or 1956 4-door Pontiac, two-tone green, which had no front license plate. No one was observed at the [redacted] residence at that time.

GA

mick is approximately 1926

On 9/15/63 at Chattanooga, Tennessee File # KX 157-189

by Special Agent [redacted] Date dictated 9/16/63

This document contains neither recommendations nor conclusions of the FBI. It is the property of the FBI and is loaned to your agency; it and its contents are not to be distributed outside your agency.

62c

Date September 20, 1963

On September 18, 1963, Special Agents [redacted] and [redacted] at [redacted] Chattanooga, Tennessee, observed parked at the dead-end of [redacted] Street, two automobiles, one a 1955 Chevrolet Convertible, 2-door, white top and white trunk, bright red body, bearing 1962 Tennessee license [redacted]. Also observed was a 1954-1956 Pontiac, 4-door, two-tone green with no front license plate.

On 9/18/63 at Chattanooga, Tennessee File # KX 157-189
by Special Agents [redacted]
and [redacted] EYP Date dictated 9/18/63

KX 157-189

62

On October 28, 1963, Special Agent [REDACTED] observed what appeared to be the remains of a red Chevrolet Convertible in a completely demolished condition in the driveway of the residence of [REDACTED] Chattanooga, Tennessee.

[REDACTED]

67c15

On November 5, 1963, anonymous telephone call to Erlanger Baroness Hospital Information Desk determined that [REDACTED] condition was fair.

On November 12, 1963, the Information Desk, Erlanger Baroness Hospital, advised that [REDACTED] had been dismissed as a patient November 6, 1963.

XXXXXX
XXXXXX
XXXXXX

FEDERAL BUREAU OF INVESTIGATION FOIPA DELETED PAGE INFORMATION SHEET

33 Page(s) withheld entirely at this location in the file. One or more of the following statements, where indicated, explain this deletion.

Deleted under exemption(s) (b)(1) (b)(7) (C) and (D) with no segregable material available for release to you.

Information pertained only to a third party with no reference to you or the subject of your request.

Information pertained only to a third party. Your name is listed in the title only.

Documents originated with another Government agency(ies). These documents were referred to that agency(ies) for review and direct response to you.

_____ Pages contain information furnished by another Government agency(ies). You will be advised by the FBI as to the releasability of this information following our consultation with the other agency(ies).

_____ Page(s) withheld for the following reason(s):

For your information: _____

The following number is to be used for reference regarding these pages:

157-1025-235

XXXXXX
XXXXXX
XXXXXX

XXXXXXXXXXXXXXXXXXXXX
X DELETED PAGE(S) X
X NO DUPLICATION FEE X
X FOR THIS PAGE X
XXXXXXXXXXXXXXXXXXXXX

UNITED STATES GOVERNMENT

Memorandum

TO : Mr. Belmont

DATE: November 27, 1963

FROM : A. Rosen

SUBJECT: UNKNOWN SUBJECTS;
BOMBING OF 16TH STREET BAPTIST CHURCH,
BIRMINGHAM, ALABAMA, 9/15/63
BOMBING MATTERS

Tolson	✓
Belmont	✓
Mohr	✓
Casper	✓
Callahan	✓
Conrad	✓
DeLoach	✓
Evans	✓
Gale	✓
Rosen	✓
Sullivan	✓
Tavel	✓
Trotter	✓
Tele. Room	✓
Holmes	✓
Gandy	✓

Reference is made to the memorandum of November 19, 1963, reflecting that an additional seven Agents and one stenographer would be released at the close of business the week ending November 23, 1963.

The matter of personnel has been re-evaluated on a current basis. At the present time, there are 17 Special Agents, including the SAC on special assignment from Little Rock, and three clerical employees. It now appears that of the 17 Agents we should phase out 9 by the close of business this week. This will include the SAC, the remaining 8 to be released no later than the middle of next week. SAC Faisst at Birmingham has been in close daily touch with this case, as well as Agents of the Birmingham Office, and they should be in a position to pursue the investigation in a forceful manner in line with the present plans and objectives which have been initiated. This case will continue to receive the utmost attention in the Birmingham Office and auxiliary offices having leads.

RECOMMENDATION:

If approved by the Director, we will immediately instruct Birmingham to phase out by the close of business this week 9 Special Agents, inclusive of the SAC on special assignment, and 3 clerical employees, the remaining Special Agents to be released no later than the middle of next week. If circumstances change in the meantime, you will immediately be advised.

- 1 - Mr. Mohr
- 1 - Mr. Callahan

AR:ige
(8)

ADDENDUM: 11/27/63 AR:ige

Birmingham Office advised of the above and appropriate action being taken in accordance therewith.

Handwritten notes:
 11/27/63
 157-1025-736
 1 07 14 33
 25 DEC 11 1963
 REC 5
 [Initials]

Handwritten:
 74 DEC 19 1963

AA

UNITED STATES GOVERNMENT

Memorandum

Tolson	<input checked="" type="checkbox"/>
Belmont	<input checked="" type="checkbox"/>
Mohr	<input type="checkbox"/>
Casper	<input type="checkbox"/>
Callahan	<input type="checkbox"/>
Conrad	<input type="checkbox"/>
DeLoach	<input type="checkbox"/>
Evans	<input type="checkbox"/>
Gale	<input type="checkbox"/>
Rosen	<input checked="" type="checkbox"/>
Sullivan	<input type="checkbox"/>
Tavel	<input type="checkbox"/>
Trotter	<input type="checkbox"/>
Tele. Room	<input type="checkbox"/>
Holmes	<input type="checkbox"/>
Gandy	<input type="checkbox"/>

Handwritten initials and signatures

TO : Mr. Belmont

DATE: December 11, 1963

FROM : A. Rosen

SUBJECT: UNKNOWN SUBJECTS;
BOMBING OF SIXTEENTH
STREET BAPTIST CHURCH
BIRMINGHAM, ALABAMA
SEPTEMBER 15, 1963
 BOMBING MATTERS

[REDACTED]

This matter is being followed and the information may be utilized to assist in future interviews of the [REDACTED] by making reference to possible fraudulent income tax returns.

Spot check surveillances of prime suspects at their residences and places of employment were made on December 10, 1963, without any significant information being developed.

Investigation is continuing to develop all information received concerning Robert Chambliss and [REDACTED] as well as other members of the Chambliss group who are prime suspects in this case.

Numerous interviews were conducted on December 10, 1963, without any additional pertinent information being developed.

ACTION:

You will be kept advised of developments.

- 1 - Mr. Mohr
- 1 - Mr. DeLoach
- 1 - Mr. Evans

PJM:tak *tak*
(9)

EX-105

REC-79

157-1025-739

DEC 12 1963

PJM

Handwritten initials

6-11

60 DEC 16 1963

Alabama

67-13

XXXXXX
XXXXXX
XXXXXX

FEDERAL BUREAU OF INVESTIGATION
FOIPA DELETED PAGE INFORMATION SHEET

1 Page(s) withheld entirely at this location in the file. One or more of the following statements, where indicated, explain this deletion.

Deleted under exemption(s) (b)(7)(C) and (D) with no segregable material available for release to you.

Information pertained only to a third party with no reference to you or the subject of your request.

Information pertained only to a third party. Your name is listed in the title only.

Documents originated with another Government agency(ies). These documents were referred to that agency(ies) for review and direct response to you.

_____ Pages contain information furnished by another Government agency(ies). You will be advised by the FBI as to the releasability of this information following our consultation with the other agency(ies).

_____ Page(s) withheld for the following reason(s):

For your information: _____

The following number is to be used for reference regarding these pages:
157-1025-238 p2

XXXXXX
XXXXXX
XXXXXX

XXXXXXXXXXXXXXXXXXXXX
X DELETED PAGE(S) X
X NO DUPLICATION FEE X
X FOR THIS PAGE X
XXXXXXXXXXXXXXXXXXXXX

PAGE THREE



TWENTY FIVE INTERVIEWS CONDUCTED. ESTIMATED FIFTYONE REMAINING.

END AND ACK

WA 10-00 PM OK FBI W A LLD

TU CLRO

DEC 11 10 12 AM '68

LEE
RECEIVED

UNITED STATES GOVERNMENT

Memorandum

Tolson	<input checked="" type="checkbox"/>
Belmont	<input checked="" type="checkbox"/>
Mohr	<input type="checkbox"/>
Casper	<input type="checkbox"/>
Callahan	<input type="checkbox"/>
Conrad	<input type="checkbox"/>
DeLoach	<input type="checkbox"/>
Evans	<input type="checkbox"/>
Gale	<input type="checkbox"/>
Rosen	<input checked="" type="checkbox"/>
Sullivan	<input type="checkbox"/>
Tavel	<input type="checkbox"/>
Trotter	<input type="checkbox"/>
Tele. Room	<input type="checkbox"/>
Holmes	<input type="checkbox"/>
Gandy	<input type="checkbox"/>

TO : Mr. Belmont

DATE: December 10, 1963

FROM : A. Rosen

SUBJECT: UNKNOWN SUBJECTS;
BOMBING OF THE SIXTEENTH
STREET BAPTIST CHURCH
BIRMINGHAM, ALABAMA
SEPTEMBER 15, 1963
BOMBING MATTERS

[REDACTED]

[REDACTED]

are being interviewed to develop information concerning him and to develop any other information that he might be involved in the bombing of the Sixteenth Street Baptist Church.

Spot check surveillances of prime suspects at their residences and places of employment were made on 12/9/63 without any significant information being developed. Numerous interviews were conducted on 12/9/63 without additional pertinent information being developed.

ACTION:

You will be kept advised of developments.

1 - Mr. Mohr
 66 Mr. DeLoach
 Mr. Evans

157-1025-736

3 DEC 11 1963

REC 48

EX-102

[Handwritten initials and signatures]

b7c, d

nc

FBI

Date: 12/3/63

Transmit the following in _____
(Type in plain text or code)

Via AIRTEL AIRMAIL
(Priority or Method of Mailing)

TO: DIRECTOR, FBI (157-1025)
ATT'N: LATENT FINGERPRINT SECTION
FROM: SAC, MOBILE (157-416)
SUBJECT: BAPBOMB

157-5563
SP-1

By airtel dated 11/4/63, Birmingham furnished to Mobile a list of 16 individuals who, according to Birmingham files, were suspects in previous bombings in the southeastern part of the country and who were believed to reside in the Mobile Division.

Birmingham requested that these individuals be identified and sufficient identifying information be furnished the Bureau in order that a comparison may be made between their fingerprints and a latent fingerprint developed by Birmingham in connection with the attempted bombing of Temple Beth-El in 1958.

A review of Mobile files reflects the following information:

Mobile has no record on 2 of the individuals named, [redacted] Birmingham had listed no address for [redacted] and had listed [redacted] address as [redacted]

Mobile has no record definitely identifiable with [redacted] concerning whom no address was listed by Birmingham. Mobile file does reflect that one [redacted] was the subject of a Labor Management Relations Act case which was closed by report of SA [redacted] 1/25/49.

There is no record of racial activity on the part of this individual and no fingerprint identification of him available in the file.

3-Bureau
3-Birmingham (157-352)
2-Mobile (1- 157-416)
1- [redacted] (1- 157-45)

EX-108

REC 12

157-1025-740

25 DEC 5 1963

Approved: _____
Special Agent in Charge

Sent _____ Per _____

CC - WICB

MO 157-416

The other 13 individuals are named below, their full names being set forth, together with birth data and FBI number or fingerprint arrest number. The Bureau is requested to compare the prints of these 13 individuals against the latent fingerprint developed by Birmingham in connection with the attempted bombing of Temple Beth-El in 1958.

[REDACTED]

✓ [REDACTED]

b7c [REDACTED]

[REDACTED]

[REDACTED]

[REDACTED]

[REDACTED]

[REDACTED]

[REDACTED]

[REDACTED]

XXXXXX
XXXXXX
XXXXXX

FEDERAL BUREAU OF INVESTIGATION
FOIPA DELETED PAGE INFORMATION SHEET

1 Page(s) withheld entirely at this location in the file. One or more of the following statements, where indicated, explain this deletion.

Deleted under exemption(s) (b)(7)(C) with no segregable material available for release to you.

Information pertained only to a third party with no reference to you or the subject of your request.

Information pertained only to a third party. Your name is listed in the title only.

Documents originated with another Government agency(ies). These documents were referred to that agency(ies) for review and direct response to you.

Pages contain information furnished by another Government agency(ies). You will be advised by the FBI as to the releasability of this information following our consultation with the other agency(ies).

Page(s) withheld for the following reason(s):

For your information: _____

The following number is to be used for reference regarding these pages:

157-1025-26 p3

XXXXXX
XXXXXX
XXXXXX

XXXXXXXXXXXXXXXXXXXXX
X DELETED PAGE(S) X
X NO DUPLICATION FEE X
X FOR THIS PAGE X
XXXXXXXXXXXXXXXXXXXXX

FEDERAL BUREAU OF INVESTIGATION

Washington, D. C. 20537



REPORT

of the

LATENT FINGERPRINT SECTION

Identification Division

December 10, 1963

YOUR FILE NO. *108*
FBI FILE NO. *157-416*
LATENT CASE NO. *157-1025-740*

45583
REV 12

TO: SAC, Mobile

RE: BAPBOMB

REFERENCE: *Airtel 12/3/63*
EXAMINATION REQUESTED BY: *Mobile*
SPECIMENS:

The two latent fingerprints in the case entitled "Unknown Subjects; Attempted Bombing of Jewish Synagogue Temple Beth-El, Birmingham, Alabama, 4/28/58," are not identical with the fingerprints of ~~_____~~ or with the fingerprints of the other twelve named suspects.

MAILED 5
DEC 10 1963
COMM-FBI

- 1 - Mobile (157-45)
- 2 - Birmingham (157-352) *copy*
- 1 - ~~Battle (100-135-4)~~ *destroyed*

- Tolson _____
- Belmont _____
- Mohr _____
- Casper _____
- Callahan _____
- Conrad _____
- DeLoach _____
- Evans _____
- Gale _____
- Rosen _____
- Sullivan _____
- Tavel _____
- Trotter _____
- Tele. Room _____
- Holmes _____
- Gandy _____

57
DEC 18 1963

J. Edgar Hoover
John Edgar Hoover, Director

THIS REPORT IS FURNISHED FOR OFFICIAL USE ONLY

MAIL ROOM TELETYPE UNIT

DEC 11 11 45 AM '63
REC'D - CIV RIGHTS
EDT

L.A. [Signature]

[Signature]

FEDERAL BUREAU OF INVESTIGATION
LATENT FINGERPRINT SECTION WORK SHEET

Recorded: 12-5-63/12:00NOON

Reference No: 157-416

Received: 12-5-63/dab

FBI File No: 157-1026-745

Latent Case No: 45563

Answer to: SAC, MOBILE

Examination requested by: Addressee

Copy to: Mobile 157-416 + 157-45

RE: BAPBOMB

Date of reference communication: 12-3-63 airtel.

Specimens:

Named suspects:

[REDACTED]

Result

Reference noted by:

compare fingerprints of suspects with latent fingerprints developed by Birmingham in connection with the attempted bombing of Temple Beth-El in 1958.

*Called for parts 12-5
Completed - no 8*

Examination completed: 12-6 3³⁰ pm

Dictated: 12-6

A

XXXXXX
XXXXXX
XXXXXX

FEDERAL BUREAU OF INVESTIGATION
FOIPA DELETED PAGE INFORMATION SHEET

2

Page(s) withheld entirely at this location in the file. One or more of the following statements, where indicated, explain this deletion.

- Deleted under exemption(s) (b)(7)(C) - (b)(7)(D) with no segregable material available for release to you.
- Information pertained only to a third party with no reference to you or the subject of your request.
- Information pertained only to a third party. Your name is listed in the title only.
- Documents originated with another Government agency(ies). These documents were referred to that agency(ies) for review and direct response to you.

_____ Pages contain information furnished by another Government agency(ies). You will be advised by the FBI as to the releasability of this information following our consultation with the other agency(ies).

_____ Page(s) withheld for the following reason(s):

For your information: _____

The following number is to be used for reference regarding these pages:
157-1025-741

XXXXXX
XXXXXX
XXXXXX

XXXXXXXXXXXXXXXXXXXXX
X DELETED PAGE(S) X
X NO DUPLICATION FEE X
X FOR THIS PAGE X
XXXXXXXXXXXXXXXXXXXXX

UNITED STATES GOVERNMENT

Memorandum

TO : Mr. Belmont

DATE: December 12, 1963

FROM : A. Rosen

Baptist

SUBJECT: UNKNOWN SUBJECTS;
BOMBING OF SIXTEENTH
STREET BAPTIST CHURCH
BIRMINGHAM, ALABAMA
SEPTEMBER 15, 1963
BOMBING MATTERS

- Tolson
- Belmont
- Mohr
- Casper
- Callahan
- Conrad
- DeLoach
- Evans
- Gale
- Rosen
- Sullivan
- Tavel
- Trotter
- Tele. Room
- Holmes
- Gandy

McGowan
PS [unclear]
[unclear]

[REDACTED]

On the night of 12/10/63 unknown persons shot metal balls by slingshot into the residence of Negro attorney Arthur D. Shores. A Birmingham racial informant has furnished the identities of several members of the Eastview Klavern, United Klans of America, whom the informant believes are involved in this matter. The informant obtained second-hand information several hours after the incident occurred indicating

- 1 - Mr. Mohr
- 1 - Mr. DeLoach
- 1 - Mr. Evans

REC-15

157-1025-742

PJM:tak
(9)

25 DEC 12 1963

Memorandum to Mr. Belmont
RE: UNKNOWN SUBJECTS; BOMBING OF
SIXTEENTH STREET BAPTIST CHURCH

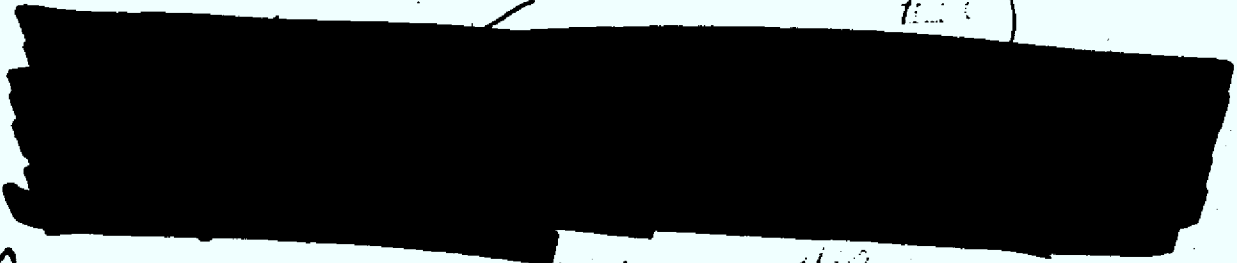
67c 1D

11-29

Numerous interviews were conducted on 12/11/63
without additional pertinent information being developed.

ACTION:

You will be kept advised of developments.

John R

DEC 13 6 44 AM '63

SEARCH SLIP

[Redacted]

R# (196) Date 50 Searcher Number 68

Prod: 1/1 Nov 27 1960

FILE NUMBER

SERIAL

I 157-125-550 57

I 51452

I 502

~~502~~ 105-12189-5484

SPECIAL FILE 1352

DEC 3 1960

(10)

1074

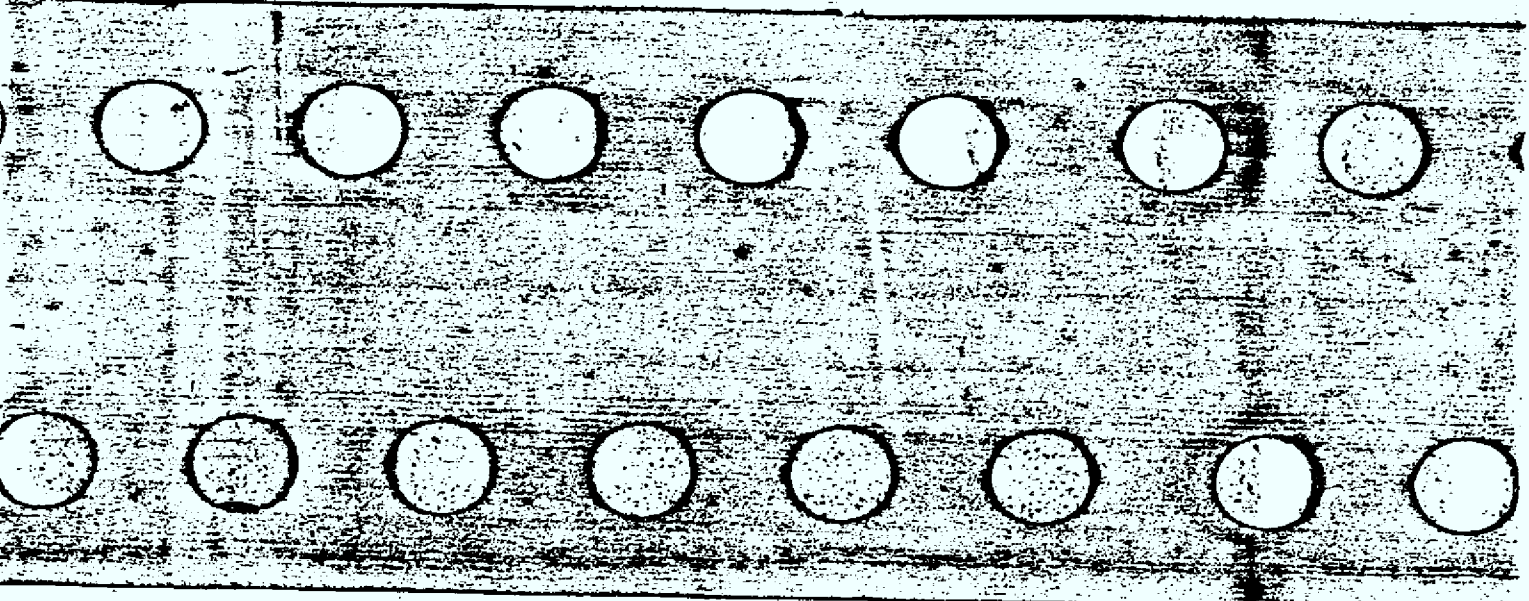
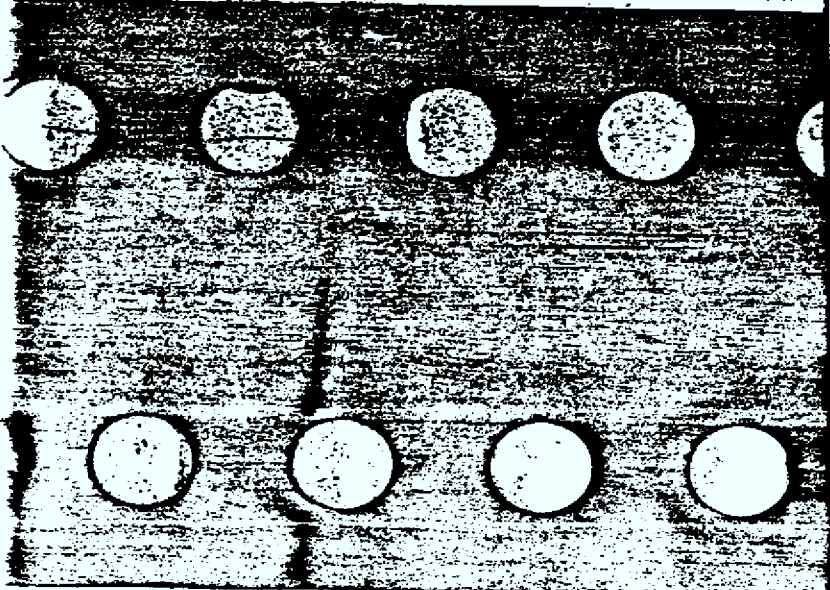

UNITED STATES GOVERNMENT

Memorandum

Tolson	<input checked="" type="checkbox"/>
Belmont	<input checked="" type="checkbox"/>
Mohr	<input type="checkbox"/>
Casper	<input type="checkbox"/>
Callahan	<input type="checkbox"/>
Conrad	<input type="checkbox"/>
DeLoach	<input checked="" type="checkbox"/>
Evans	<input checked="" type="checkbox"/>
Gale	<input checked="" type="checkbox"/>
Rosen	<input checked="" type="checkbox"/>
Sullivan	<input type="checkbox"/>
Tavel	<input type="checkbox"/>
Trotter	<input type="checkbox"/>
Tele. Room	<input type="checkbox"/>
Holmes	<input type="checkbox"/>
Gandy	<input type="checkbox"/>

TO : Mr. Belmont

DATE: December 13, 1963

FROM : A. Rosen *ARM*

SUBJECT: UNKNOWN SUBJECTS;
BOMBING OF SIXTEENTH
STREET BAPTIST CHURCH
BIRMINGHAM, ALABAMA
SEPTEMBER 15, 1963
BOMBING MATTERS

67D

[REDACTED]

67c

[REDACTED] a principal suspect in the bombing of the Sixteenth Street Baptist Church, was at his residence the entire evening of December 10, 1963, the night the steel balls were shot into Arthur Shores' residence.

[REDACTED]

[REDACTED] another principal suspect in the bombing of the Sixteenth Street Baptist Church, refused to talk to Agents on advice of his attorney, Matt Murphy. Murphy has been acting as attorney for leading racial agitators in Birmingham.

Spot check surveillances of prime suspects at their residences and places of employment were made on December 12, 1963, without any significant information being developed. Numerous interviews were conducted on December 12, 1963, without any additional pertinent information being developed.

ACTION:

You will be kept advised of developments.

- 1 - Mr. Mohr
- 1 - Mr. DeLoach
- 1 - Mr. Evans

PJM: tak *tak*

(9)

REC-50
Rg pgm
157-1025-743
DEC 19 1963

FEDERAL BUREAU OF INVESTIGATION
U. S. DEPARTMENT OF JUSTICE
COMMUNICATIONS SECTION

DEC 11 1953

TELETYPE

Dist

Mr. Tolson	_____
Mr. Belmont	_____
Mr. Mohr	_____
Mr. Casper	_____
Mr. Callahan	_____
Mr. Conrad	_____
Mr. DeLoach	_____
Mr. Evans	_____
Mr. Gale	_____
Mr. Rosen	_____
Mr. Sullivan	_____
Mr. Tavel	_____
Mr. Trotter	_____
Tele. Room	_____
Miss Holmes	_____
Miss Gandy	_____

URGENT 12-11-63 8-24 PM CST HEP

TO DIRECTOR

FROM SAC BIRMINGHAM /157-352/ 3P

2 Copies made for records by [unclear] 12-79

BAPBOMB.

DAILY SUMMARY.

[REDACTED]

[REDACTED]

[REDACTED]

[REDACTED]

[REDACTED]

[REDACTED]

[REDACTED]

[REDACTED]

[REDACTED]

[REDACTED]

DEPARTED VIA PERSONAL CAR EARLY AFTERNOON, DECEMBER ELEVEN, SIX THREE, FOR ATLANTA. ATLANTA ADVISED.

END PAGE ONE

53 DEC 16 1953

Rosen to Belmont

12/12/63

JM: take

REC-104

157-1025-1411

12 DEC 13 1953

6

XXXXXX
XXXXXX
XXXXXX

FEDERAL BUREAU OF INVESTIGATION FOIPA DELETED PAGE INFORMATION SHEET

1 Page(s) withheld entirely at this location in the file. One or more of the following statements, where indicated, explain this deletion.

Deleted under exemption(s) (b)(7)(D) and (D) with no segregable material available for release to you.

Information pertained only to a third party with no reference to you or the subject of your request.

Information pertained only to a third party. Your name is listed in the title only.

Documents originated with another Government agency(ies). These documents were referred to that agency(ies) for review and direct response to you.

_____ Pages contain information furnished by another Government agency(ies). You will be advised by the FBI as to the releasability of this information following our consultation with the other agency(ies).

_____ Page(s) withheld for the following reason(s):

For your information: _____

The following number is to be used for reference regarding these pages:

157-1025-744 p2

XXXXXX
XXXXXX
XXXXXX

XXXXXXXXXXXXXXXXXXXXX
X DELETED PAGE(S) X
X NO DUPLICATION FEE X
X FOR THIS PAGE X
XXXXXXXXXXXXXXXXXXXXX

6210
PAGE THREE.

[REDACTED]

SEVENTEEN INTERVIEWS CONDUCTED. ESTIMATED FORTY INTERVIEWS
REMAINING.

ACK AND HOLD PLS

9-32 PM OK FBI WA LLD

Date of Mail 11-19-63

Has been removed and placed in the Special File Room of Records Branch.

20
for rec...
Date
- 65
- 18-79
FORCP

See File 66-2554-7530 for authority.

Subject JUNE MAIL Baybomba

Removed By 65 DEC 23 1963

File Number 157-1025-745

XXXXXX
XXXXXX
XXXXXX

FEDERAL BUREAU OF INVESTIGATION
FOIPA DELETED PAGE INFORMATION SHEET

5

Page(s) withheld entirely at this location in the file. One or more of the following statements, where indicated, explain this deletion.

Deleted under exemption(s) (1) (2) (L) (7) (C) with no segregable material available for release to you.

Information pertained only to a third party with no reference to you or the subject of your request.

Information pertained only to a third party. Your name is listed in the title only.

Documents originated with another Government agency(ies). These documents were referred to that agency(ies) for review and direct response to you.

_____ Pages contain information furnished by another Government agency(ies). You will be advised by the FBI as to the releasability of this information following our consultation with the other agency(ies).

_____ Page(s) withheld for the following reason(s):

For your information: _____

The following number is to be used for reference regarding these pages:

157-1025-745

XXXXXX
XXXXXX
XXXXXX

XXXXXXXXXXXXXXXXXXXXX
X DELETED PAGE(S) X
X NO DUPLICATION FEE X
X FOR THIS PAGE X
XXXXXXXXXXXXXXXXXXXXX

Date of Mail 11-26-63

Has been removed and placed in the Special File Room of Records Branch; removed by Rowe Task Force
Dec 1-8-63

See File 66-2554-7530 for authority.

Subject JUNE MAIL Bupbombs

Removed By 65 DEC 23 1963

File Number 157-1025-746

1A
51

F B I

Date: 11/26/63

Transmit the following in _____
(Type in plain text or code)

Via AIRTEL AIR MAIL
(Priority or Method of Mailing)

TO: DIRECTOR, FBI (157-1025)
FROM: SAC, BIRMINGHAM (157-352)(SF 2)
SUBJECT: BAPBOMB

JUNE

RE: Birmingham airtel to the Bureau 11/21/63,
advising that six Tesurs in operation this office will
be removed, as follows:

11/21/63 [REDACTED]

11/22/63 [REDACTED]

11/23/63 [REDACTED]

62
67c

[REDACTED]

All Tesurs have been removed as follows:

[REDACTED]

NSRP
ROBERT E. CHAMBLISS

10:30 AM 11/25/63
12:10 PM

③ - Bureau (AM) RM
2 - Birmingham

REC-89

157-1025-746

12-16
5 NOV 27 1963

[REDACTED] K2

Approved: _____ Sent _____ M Per _____

C. C. Wick 6 DEC 23 1963 Special Agent in Charge

1. D. [Signature]
[Stamps and signatures]

UNITED STATES GOVERNMENT

Memorandum

Tolson	_____
Belmont	_____
Mohr	_____
Casper	_____
Callahan	_____
Conrad	_____
DeLoach	_____
Evans	_____
Gale	_____
Rosen	_____
Sullivan	_____
Tavel	_____
Trotter	_____
Tele. Room	_____
Holmes	_____
Gandy	_____

TO : Mr. Belmont *albo*

DATE: December 9, 1963

FROM : A. Rosen *Rm*

SUBJECT: UNKNOWN SUBJECTS;
BOMBING OF SIXTEENTH
STREET BAPTIST CHURCH
BIRMINGHAM, ALABAMA
SEPTEMBER 15, 1963
BOMBING MATTERS

Baptist

McGriff

1-1
d

[REDACTED]

[REDACTED]

Investigation being conducted to ascertain the degree of involvement of [REDACTED] with Chambliss.

[REDACTED]

[REDACTED]

- 1 - Mr. Mohr
- 1 - Mr. DeLoach
- 1 - Mr. Evans

PJM:tak
(9)

REC-34

157-1003-574

ST-104

12 DEC 13 1963

6-M

58 DEC 18 1963

67010

Memorandum to Mr. Belmont
RE: UNKNOWN SUBJECTS; BOMBING OF
SIXTEENTH STREET BAPTIST CHURCH

[REDACTED]

b7c
b7d

We are continuing to develop information concerning Robert Chambliss and [REDACTED] as well as other members of the Chambliss group who are prime suspects in this case.

Surveillances of prime suspects at their residence and places of employment were made without any unusual activity being noted. Additional interviews were conducted on 12/7 and 8/63 with no additional pertinent information being developed.

ACTION:

You will be kept advised of developments.

Keegan
pgm *6/20/63* *P* *JA*

FEDERAL BUREAU OF INVESTIGATION
U. S. DEPARTMENT OF JUSTICE
COMMUNICATIONS SECTION

DEC 13 1963

TELETYPE

Mr. Tolson	_____
Mr. Belmont	_____
Mr. Mohr	_____
Mr. Casper	_____
Mr. Callahan	_____
Mr. Conrad	_____
Mr. DeLoach	_____
Mr. Evans	_____
Mr. Gale	_____
Mr. Rosen	_____
Mr. Sullivan	_____
Mr. Tavel	_____
Mr. Trotter	_____
Tele. Room	_____
Miss Holmes	_____
Miss Gandy	_____

John [unclear]

URGENT 12-13-63 8-15 PM CST HEP

TO DIRECTOR

FROM SAC BIRMINGHAM /157-352/ 3P

BAPBOMB

DAILY SUMMARY.

[Handwritten initials]
[Handwritten initials]

[REDACTED]

END PAGE ONE.

REC-22

157-1025-748

EX-102

15 DEC 16 1963

a [unclear]

[Handwritten initials]
[Handwritten initials]

64 DEC 23 1963

XXXXXX
XXXXXX
XXXXXX

FEDERAL BUREAU OF INVESTIGATION FOIPA DELETED PAGE INFORMATION SHEET

 1 Page(s) withheld entirely at this location in the file. One or more of the following statements, where indicated, explain this deletion.

Deleted under exemption(s) (b)(7)(C) and (D) with no segregable material available for release to you.

Information pertained only to a third party with no reference to you or the subject of your request.

Information pertained only to a third party. Your name is listed in the title only.

Documents originated with another Government agency(ies). These documents were referred to that agency(ies) for review and direct response to you.

 Pages contain information furnished by another Government agency(ies). You will be advised by the FBI as to the releasability of this information following our consultation with the other agency(ies).

 Page(s) withheld for the following reason(s):

For your information: _____

The following number is to be used for reference regarding these pages:
157-1025-748 p 2

XXXXXX
XXXXXX
XXXXXX

XXXXXXXXXXXXXXXXXXXXX
X DELETED PAGE(S) X
X NO DUPLICATION FEE X
X FOR THIS PAGE X
XXXXXXXXXXXXXXXXXXXXX

PAGE THREE.

67-1357

[REDACTED]

SPOT CHECK OF RESIDENCE OF POP BLANTON, [REDACTED]

[REDACTED] REVEALS HE IS VERY SELDOM AT HOME AND [REDACTED]

FIFTEEN INTERVIEWS CONDUCTED. FORTYFOUR ESTIMATED REMAINING.

END

9-24 PM OK FBI WA WS

CLR

DEC 10 1 00 PM '90

SEARCHED
SERIALIZED
INDEXED
FILED

DEC 10 1990
FBI
WA

11/17 to 12/15/63

FEDERAL BUREAU OF INVESTIGATION
U.S. DEPARTMENT OF JUSTICE
COMMUNICATIONS SECTION

DEC 15 1963

TELETYPE

URGENT 12-15-63 7-41 PM CST WCR

TO DIRECTOR /157-1025/

FROM SAC, BIRMINGHAM /157-352/

BAPBOMB.

DAILY SUMMARY.

COURT RECORDS COVERING RECENT TRIAL OF JOHN WESLEY

HALL, ROBERT CHAMBLIS, AND CHARLES A. CAGLE HAVE BEEN PARTIALLY REVIEWED AND NO INFORMATION WHICH WAS NOT ALREADY IN POSSESSION OF BIRMINGHAM OFFICE HAS BEEN REVEALED. REVIEW OF THESE COURT RECORDS WILL BE COMPLETED. ANY NEW AND PERTINENT INFORMATION IF SUCH IS DEVELOPED WILL BE FULLY EXPLORED.

ALL

FILE

[REDACTED] DRIVING ONE NINE FIVE SEVEN MERCURY ALABAMA ONE NINE SIX FOUR LICENSE NUMBER

[REDACTED]

EMPLOYEES AT [REDACTED] WHO RIDE IN CAR POOLS AND WITH WHOM [REDACTED] HAS RIDDEN WERE IDENTIFIED

REC-39

157-1025-74

ALL OF [REDACTED] ALABAMA AND [REDACTED] BIRMINGHAM, ALABAMA. BACKGROUND BEING

DEC 16 1963

CONDUCTED AND INTERVIEWS WILL BE HELD. SPOT CHECKS OF PRINCIPAL SUSPECTS MADE AND NO PERTINENT DEVELOPMENTS. TWO INTERVIEWS HELD APPROXIMATELY FORTY REMAINING.

END ACK PLS
8-46 PM OK FBI WA WS

cc Lavin

Mr. Tolson	_____
Mr. Belmont	_____
Mr. Mohr	_____
Mr. Casper	_____
Mr. Callahan	_____
Mr. Conrad	_____
Mr. DeLoach	_____
Mr. Evans	_____
Mr. Gale	_____
Mr. Rosen	_____
Mr. Sullivan	_____
Mr. Tavel	_____
Mr. Trotter	_____
Tele. Room	_____
Miss Holmes	_____
Miss Gandy	_____

PAGE TWO.

[REDACTED]

INVESTIGATION WILL BE CONDUCTED TO DETERMINE WHERE AND WHEN HUDSON WAS OBTAINED BY [REDACTED] IN CONNECTION WITH HUDSON CLUTCH PLATE USED IN SHRAPNEL BOMB.

67019

[REDACTED]

SPOT CHECKS FISURS TODAY NOT PRODUCTIVE. TWELVE INTERVIEWS CONDUCTED. ABOUT FIFTY PENDING.

END

9-55 PM OK FBI WA LLD

TU CLR

00012 A 12 11 1955

LEE
REG. OF. MICHIGAN

12/14/63

FEDERAL BUREAU OF INVESTIGATION
U. S. DEPARTMENT OF JUSTICE
COMMUNICATIONS SECTION

DEC 14 1963

TELETYPE

Mr. Tolson	_____
Mr. Belmont	_____
Mr. Mohr	_____
Mr. Casper	_____
Mr. Callahan	_____
Mr. Conrad	_____
Mr. DeLoach	_____
Mr. Evans	_____
Mr. Gale	_____
Mr. Rosen	_____
Mr. Sullivan	_____
Mr. Tavel	_____
Mr. Trotter	_____
Tele. Room	_____
Miss Holmes	_____
Miss Gandy	_____

McGowan

URGENT 12-14-63 7-05 PM CST HEP

TO DIRECTOR :

FROM SAC BIRMINGHAM /157-352/ 3P

Copies made by
for review by Rowe Task Force
Date 12-14-63

BAPBOMB

DAILY SUMMARY.

DEC 14 1963

[REDACTED]

EFFORTS BEING MADE TO DEVELOP FURTHER INFORMATION CONCERNING THIS MATTER.

OBSERVATION OF [REDACTED] CAR HAS DETERMINED IT TO BE A NINETEEN FIFTYTWO DASH FIFTYTHREE HUDSON WITH AUTOMATIC DRIVE.

[REDACTED]

END PAGE ONE

*Recd. SAC BH
12/14/63
[Signature]*

REC-3

157-1025-701

6 550 17 1963

cc [Signature]

[Signature]

PAGE TWO.

[REDACTED]

[REDACTED] REFUSED TO

SUBMIT TO POLYGRAPH AT THIS TIME. INVESTIGATION CONTINUING.

22

[REDACTED]

67-269

INFORMATION RE [REDACTED] REPORTED TO BUREAU BAPBOMB
SUMMARY TEL NOVEMBER SEVEN, SIXTYTHREE, AND BAPBOMB REPORT, NOVEMBER
FIFTEEN, SIXTYTHREE. [REDACTED]

END PAGE TWO.

PAGE THREE.

[REDACTED]

51751

[REDACTED] IN VIEW OF RESULTS OF POLYGRAPH, IS BELIEVED INFORMATION
MAY HAVE BEEN PLANTED [REDACTED]

[REDACTED]

SEVEN INTERVIEWS CONDUCTED. APPROXIMATELY FORTYONE REMAINING.

END

MM

8-15 PM OK FBI WA WS

TU M

XXXXXX
XXXXXX
XXXXXX

FEDERAL BUREAU OF INVESTIGATION
FOIPA DELETED PAGE INFORMATION SHEET

1 Page(s) withheld entirely at this location in the file. One or more of the following statements, where indicated, explain this deletion.

Deleted under exemption(s) (b) (7) (c) and (D) with no segregable material available for release to you.

Information pertained only to a third party with no reference to you or the subject of your request.

Information pertained only to a third party. Your name is listed in the title only.

Documents originated with another Government agency(ies). These documents were referred to that agency(ies) for review and direct response to you.

_____ Pages contain information furnished by another Government agency(ies). You will be advised by the FBI as to the releasability of this information following our consultation with the other agency(ies).

_____ Page(s) withheld for the following reason(s):

For your information: _____

The following number is to be used for reference regarding these pages:
157-1025-751

XXXXXX
XXXXXX
XXXXXX

XXXXXXXXXXXXXXXXXXXXX
X DELETED PAGE(S) X
X NO DUPLICATION FEE X
X FOR THIS PAGE X
XXXXXXXXXXXXXXXXXXXXX

XXXXXX
XXXXXX
XXXXXX

FEDERAL BUREAU OF INVESTIGATION
FOIPA DELETED PAGE INFORMATION SHEET

6 Page(s) withheld entirely at this location in the file. One or more of the following statements, where indicated, explain this deletion.

- Deleted under exemption(s) (b)(7)(C) and (D) with no segregable material available for release to you.
- Information pertained only to a third party with no reference to you or the subject of your request.
- Information pertained only to a third party. Your name is listed in the title only.
- Documents originated with another Government agency(ies). These documents were referred to that agency(ies) for review and direct response to you.

_____ Pages contain information furnished by another Government agency(ies). You will be advised by the FBI as to the releasability of this information following our consultation with the other agency(ies).

_____ Page(s) withheld for the following reason(s):

For your information: _____

The following number is to be used for reference regarding these pages:
157-1025-752

XXXXXX
XXXXXX
XXXXXX

XXXXXXXXXXXXXXXXXXXXX
X DELETED PAGE(S) X
X NO DUPLICATION FEE X
X FOR THIS PAGE X
XXXXXXXXXXXXXXXXXXXXX

FEDERAL BUREAU OF INVESTIGATION

REPORTING OFFICE NEW ORLEANS	OFFICE OF ORIGIN BIRMINGHAM	DATE 12/13/63	INVESTIGATIVE PERIOD 10/18/63 - 12/5/63
TITLE OF CASE UNSUBS; Bombing of 16th Street Baptist Church, Birmingham, Alabama, 9/15/63		REPORT MADE BY SA [REDACTED]	TYPED BY gas
		CHARACTER OF CASE BOMBING MATTERS	

REFERENCES

Philadelphia airtel to Bureau, 10/19/63.
Report of SA [REDACTED] 11/15/63, at New Orleans.

P

LEADS

NEW ORLEANS DIVISION

AT NEW ORLEANS, LOUISIANA

Will continue contacts with informants, sources, and law enforcement agencies for the identities of possible suspects.

DEC 12 11 30 AM '63
REC'D - CIVIL RIGHTS

APPROVED <i>[Signature]</i>	SPECIAL AGENT IN CHARGE	DO NOT WRITE IN SPACES BELOW	
COPIES MADE ⑤ Bureau (157-1025) 2-Birmingham (157-325) 2-New Orleans (157-1294)		157-1025-1753 DEC 13 1963	REG-34 157-102
DISSEMINATION RECORD OF ATTACHED REPORT		NOTATIONS	
AGENCY	F.C.C. C.R.D. & Criminal Div		
REQUEST RECD.			
DATE FWD.	12-17-63	4/26/64 ✓	
HOW FWD.	A.S. 6-94	6-194B	
BY	gas-gh	het-dgd	

NO 157-1294

ADMINISTRATIVE

To date no pertinent information regarding possible suspects has been received from informants, sources or law enforcement agencies. Their identities are not being set forth but are being retained in the New Orleans file in this matter.

B*

COVER PAGE

XXXXXX
XXXXXX
XXXXXX

FEDERAL BUREAU OF INVESTIGATION
FOIPA DELETED PAGE INFORMATION SHEET

6 Page(s) withheld entirely at this location in the file. One or more of the following statements, where indicated, explain this deletion.

- Deleted under exemption(s) (b)(7)(C) and (D) with no segregable material available for release to you.
- Information pertained only to a third party with no reference to you or the subject of your request.
- Information pertained only to a third party. Your name is listed in the title only.
- Documents originated with another Government agency(ies). These documents were referred to that agency(ies) for review and direct response to you.

_____ Pages contain information furnished by another Government agency(ies). You will be advised by the FBI as to the releasability of this information following our consultation with the other agency(ies).

_____ Page(s) withheld for the following reason(s):

For your information: _____

The following number is to be used for reference regarding these pages:

157-1025-253 p 1-6

XXXXXX
XXXXXX
XXXXXX

XXXXXXXXXXXXXXXXXXXXX
X DELETED PAGE(S) X
X NO DUPLICATION FEE X
X FOR THIS PAGE X
XXXXXXXXXXXXXXXXXXXXX

1243
1243
ALM
7/22/63

FEDERAL BUREAU OF INVESTIGATION
U. S. DEPARTMENT OF JUSTICE
COMMUNICATIONS SECTION
DEC 17 1963

TELETYPE

Mr. Tolson	_____
Mr. Belmont	_____
Mr. Mohr	_____
Mr. Casper	_____
Mr. Callahan	_____
Mr. Conrad	_____
Mr. DeLoach	_____
Mr. Evans	_____
Mr. Gale	_____
Mr. Rosen	_____
Mr. Sullivan	_____
Mr. Tavel	_____
Mr. Trotter	_____
Tele. Room	_____
Miss Holmes	_____
Miss Gandy	_____

W. Johnson

F. J. [unclear]

W. J. [unclear]
1

URGENT 12-16-63 10-50 PM CST GDM

TO DIRECTOR

FROM SAC, BIRMINGHAM /157-352/ 4P

BAPBOMB DAILY SUMMARY.

2 copies of [unclear] for [unclear] dated 12-19-63
Rel only

[REDACTED]

REC-56

157-1025-154

END PAGE ONE 7 DEC 20 1963

25 DEC 18 1963

277

6

b7c

PAGE TWO

IS NO INFO EXCEPT PURE CONJECTURE TO DISSEMINATE AND NO KNOWN MANNER OF NOTIFYING LOCAL AUTHORITIES OF POSSIBLE ACTION AGAINST [REDACTED] AND STILL COMPLETELY INSURE THAT INFORMANTS IDENTITY IS NOT JEAPARDIZE

[REDACTED]

b7c

A REVIEW OF THE OCTOBER NINE SIXTYTHREE, TRIALS OF ROBERT E. CHAMBLISS, JOHN WESLEY HALL AND CHARLES CAGLE ON LOCAL CHARGES OF ILLEGAL POSSESSION OF DYNAMITE HAS BEEN COMPLETED. NO INFORMATION WAS CONTAINED IN THE TRANSCRIPTS OF THESE TRIALS WHICH WAS NOT ALREADY IN POSSESSION OF THE BIRMINGHAM OFFICE.

[REDACTED]

b7c

KLAN.

END PAGE TWO

PAGE THREE

[REDACTED]

620. D

[REDACTED] THOMAS ELANTON SR. WAS OBSERVED TWELVE SIXTEEN SIXTYTHREE RECORDING THE LICENSE NUMBER OF BUCAR, WHICH HAD STOPPED AT A TRAFFIC LIGHT, IN DOWNTOWN BIRMINGHAM.

[REDACTED] WAS AT HIS RESIDENCE ON SATURDAY DECEMBER FOURTEEN, SIXTYTHREE. ON DECEMBER SIXTEEN SIXTYTHREE [REDACTED]

[REDACTED] BIRMINGHAM UNTIL ABOUT FOUR FIFTY PM AND DEPARTED FOR HOME AS A PASSENGER IN NINETEEN FIFTY EIGHT FORD, NINETEEN SIXTYFOUR LICENSE [REDACTED] THE FORD AND LICENSE HAVE BEEN PREVIOUSLY NOTED.

[REDACTED] IS STILL RESIDING IN A ROOMING HOUSE AT [REDACTED]

END PAGE THREE

PAGE FOUR

SIXTEEN INTERVIEWS CONDUCTED. ABOUT THIRTYFIVE PENDING.

END AND ACK AND HOLD

WA 12-04 ZAM OK FBI WA JS

DEC 11 1964

FBI

Date: 12/2/63

Transmit the following in _____
(Type in plain text or code)

Via AIRTEL AIRMAIL _____
(Priority or Method of Mailing)

TO: DIRECTOR, FBI (Atten: AL ROSEN, General Investigative Division) (PERSONAL)

FROM: SAC ROY K. MOORE

RE: BAPBOMB

62 There are enclosed herewith certain FD-302's and memoranda dealing with the principal suspects in the BAPBOMB case, _____, and ROBERT E. CHAMBLISS, for the Bureau's consideration as to the possibility of presenting the facts concerning them (and possibly others) to a State Grand Jury. It is suggested that the over-all picture also be discussed with the U. S. Attorney at Birmingham before presentation to the local Circuit Solicitor for Grand Jury action.

The following is suggested for the Bureau's consideration:

(1) Two counts in the indictment: (1) conspiracy to commit bombing, and (2) murder.

Alabama State Statutes for dynamiting and conspiracy:

"Title 14, Section 123

Exploding or setting off dynamite; penalty for

Any person who wilfully sets off or explodes any dynamite or other explosive in, under or dangerously

- 3 - Bureau (Enc 1)
- 2 - Birmingham

RMK:nlc
(5)

ENCLOSURE

EX-105 REC-18

157-1025-755

12 DEC 19 1963

BH 157-352

near to any steam boat or vessel or rail-road car in which there is at the time any human being, or any prison or jail or any other house or building which is occupied by a person lodged therein or any inhabited dwelling house or any house adjoining such house whether there is at the time in such house adjoining a dwelling house a human being or not shall on conviction be punished at the discretion of the jury by death or by imprisonment in the penitentiary for not less than ten years."

"Title 14, Section 99

Conspiracy to commit certain felonies

Any two or more persons conspiring together to commit an assault on another with intent to murder, maim, rob, ravish, or to commit the crime against nature, or who attempt to poison any human being, or to commit murder by any means not amounting to an assault, shall each themselves be guilty of a felony, and shall, on conviction, be imprisoned in the penitentiary of the State of Alabama for not less than one year, and not more than ten years."

675
While [REDACTED] and CHAMBLISS would be the prime suspects, others should be named in the conspiracy and could testify without being indicted, the possibility exists they might "open up" and tell all. THOMAS BLANTON, Sr. [REDACTED]

[REDACTED], and [REDACTED] are persons in this category. There are several other Klansmen that the prosecutor might deem advisable to subpoena who would possibly "break" under this Grand

BH 157-352

Jury inquiry, e.g., those who broke off from the East-view Klavern and were forming the new "action group" at Cahaba River. Several of these and other klansmen can testify as to the other acts of violence and many of them have said that they did not want to furnish any information to the Agents at this time, but if they were confronted with a warrant of arrest or a Grand Jury subpoena they would give consideration to furnishing information.

(2) First witness should be a Special Agent thoroughly cognizant with all ramifications of BAPBOMB to give the over-all story. (He would have in his possession the enlarged pictures of the four deceased Negro girls, as well as "before" and "after" pictures of victim church.)

b7c
(3) Serious consideration should be given to having [redacted] testify as a "polygraph expert". (We understand there is a precedent for this.) He could testify which persons "failed" their exam. He is an impressive witness.

(4) In the presentation of the conspiracy case, the Circuit Solicitor could call the conspirators, or other klansmen, at that time he would deem propitious to the presentation, so as to show the best possible picture. b7c

The suggested witnesses as concerns [redacted] are:

(1) Special Agent, FBI - (to tell over-all story).

b7c
(2) SA [redacted] polygraph expert, to show failure to pass.

b7c
(3) [redacted]

b7c
(4) [redacted]

BH 157-352

[REDACTED]

[REDACTED]

(6) [REDACTED] can testify to

[REDACTED] (this would necessarily reveal this infor-
mant and he would have to be given due recompense and redress
establish in another part of the Country.) All reports would
be considered, or an Agent could give the content of his reports
and informant's identity preserved as an informant until necessary
for Petit Jury.

6129

[REDACTED]

[REDACTED]

ROBERT E. CHAMBLISS:

(1) Agent to give over-all story.

(2) [REDACTED]

XXXXXX
XXXXXX
XXXXXX

FEDERAL BUREAU OF INVESTIGATION
FOIPA DELETED PAGE INFORMATION SHEET

 1 Page(s) withheld entirely at this location in the file. One or more of the following statements, where indicated, explain this deletion.

Deleted under exemption(s) (b)(7)(C) and (D) with no segregable material available for release to you.

Information pertained only to a third party with no reference to you or the subject of your request.

Information pertained only to a third party. Your name is listed in the title only.

Documents originated with another Government agency(ies). These documents were referred to that agency(ies) for review and direct response to you.

 Pages contain information furnished by another Government agency(ies). You will be advised by the FBI as to the releasability of this information following our consultation with the other agency(ies).

 Page(s) withheld for the following reason(s):

For your information: _____

The following number is to be used for reference regarding these pages:

157-1025-755 p5

XXXXXX
XXXXXX
XXXXXX

XXXXXXXXXXXXXXXXXXXXX
X DELETED PAGE(S) X
X NO DUPLICATION FEE X
X FOR THIS PAGE X
XXXXXXXXXXXXXXXXXXXXX

BH 157-352

(4) [REDACTED]

(5) [REDACTED]

(they could testify re other acts of violence and bombing, if they will.)

(6) [REDACTED]

(7) [REDACTED]

(8) [REDACTED]

The foregoing does not intend to tell the full story that could be presented. Should the Bureau favorably consider this suggestion the entire file would be reviewed and a prosecutive summary report prepared. (Enclosed are some of the FD-302's and memoranda that would be used in such a summary.)

b7c
D

12/18/63

Airtel

EX-105

To: Birmingham (157-352)
From: Director, FBI (157-1025) 755

REC-18

RAPBOMB

Reurairtel 12/2/63.

Promptly prepare a prosecutive summary report in this matter. Furnish Bureau five copies of report. You should prepare an extra copy of forthcoming report for possible future dissemination to U. S. Attorney, Birmingham; however, no dissemination is to be made of forthcoming report without prior instructions from Bureau.

FPS/cbm
(4)

[Handwritten signature and scribbles]

145

7 DEC 23 1963

MAILED 25
DEC 18 1963
COMM-FBI

MAIL ROOM TELETYPE UNIT



FEDERAL BUREAU OF INVESTIGATION

REPORTING OFFICE OKLAHOMA CITY	OFFICE OF ORIGIN BIRMINGHAM	DATE 12/3/63	INVESTIGATIVE PERIOD 11/19 - 11/21/63
TITLE OF CASE UNKNOWN SUBJECT; Bombing of 16th Street Baptist Church, Birmingham, Alabama, September 15, 1963		REPORT MADE BY [REDACTED] b2c	TYPED BY msb
		CHARACTER OF CASE BOMBING MATTERS	

REFERENCE: Birmingham airtel to Oklahoma City, dated 11/8/63.
 Atlanta airtel to Oklahoma City, dated 11/14/63,
 captioned **[REDACTED]** EFP; ITSMV.
 Oklahoma City airtel to Director, dated 11/20/63:

- P -

LEADS

THE KNOXVILLE DIVISION

At Knoxville, Tennessee

Will ascertain identity of all employees of **[REDACTED]**
 Attempt to determine through **[REDACTED]** Bank and
 Retail Credit Sources if **[REDACTED]**

Reference and requested to do so
 by Office of Origin, Birmingham.

THE MOBILE DIVISION

APPROVED *[Signature]* SPECIAL AGENT IN CHARGE

COPIES MADE:
 2-Bureau (157-1025)
 1-Atlanta (76-2435) (info)
 3-Birmingham (157-352)
 2-Knoxville (157-189) (info)
 (1-Knoxville, 26-14829)
 2-Mobile
 1-New Orleans (info)
 3-Oklahoma City (157-167)
 (1-Oklahoma City (76-2726)

DO NOT WRITE IN SPACES BELOW

157-1025 - *[Handwritten]*
 17 DEC 1963
[Handwritten signatures and initials]

Dissemination Record of Attached Report

Notations

Agency			
Request Recd.			
Date Fwd.			
How Fwd.			
By			

[Handwritten signatures and stamps]
 SIX
 STAFF SECT.

58 DEC 30 1963

At Montgomery, Alabama

Will ascertain identity of all employees of [redacted] Ascertain through banking and credit channels if [redacted] and Delmar Used Car Lot at Knoxville are associated in business. Will hold lead to interview [redacted] concerning Bombing of Church in abeyance until requested to do so by Office of Origin, Birmingham.

627

THE BIRMINGHAM DIVISION

At Birmingham, Alabama

Will advise Knoxville and Mobile when desirous of having [redacted] and [redacted] interviewed.

627
D

At Cullman, Alabama

Will interview [redacted] concerning knowledge of instant bombing if desired by Office of Origin.

THE NEW ORLEANS DIVISION

One copy of report being sent for information.

THE ATLANTA DIVISION

One copy of report being sent for information.

THE OKLAHOMA CITY DIVISION

At Tulsa, Oklahoma

At Sheriff's Office, Tulsa, Oklahoma, ascertain if they have any of [redacted] property and if so, advise if 1963 Georgia registration with the property.

627

ADMINISTRATIVE:

All information contained in this report concerning stolen motor vehicles and check matters are being consolidated into an additional report, which will be captioned [redacted] aka., EFP; ITSMV, in which the Office of Origin is Atlanta.

627

OC 157-167

Color photographs have been taken and will be forwarded to Birmingham, Mobile and Knoxville upon completion of development.

62c 10 [REDACTED] has advised he is willing to submit to polygraph examination in regard to information furnished, and it is requested that Birmingham advise Oklahoma City if request for the polygraph examination to be submitted to the Bureau.

- C* -
COVER PAGE

XXXXXX
XXXXXX
XXXXXX

FEDERAL BUREAU OF INVESTIGATION
FOIPA DELETED PAGE INFORMATION SHEET

11 Page(s) withheld entirely at this location in the file. One or more of the following statements, where indicated, explain this deletion.

Deleted under exemption(s) (b)(7)(C) and (D) with no segregable material available for release to you.

Information pertained only to a third party with no reference to you or the subject of your request.

Information pertained only to a third party. Your name is listed in the title only.

Documents originated with another Government agency(ies). These documents were referred to that agency(ies) for review and direct response to you.

_____ Pages contain information furnished by another Government agency(ies). You will be advised by the FBI as to the releasability of this information following our consultation with the other agency(ies).

_____ Page(s) withheld for the following reason(s):

For your information: _____

The following number is to be used for reference regarding these pages:

157-1025-756 pt-11

XXXXXX
XXXXXX
XXXXXX

XXXXXXXXXXXXXXXXXXXXX
X DELETED PAGE(S) X
X NO DUPLICATION FEE X
X FOR THIS PAGE X
XXXXXXXXXXXXXXXXXXXXX

UNITED STATES GOVERNMENT

Memorandum

TO : Director, FBI (157-1025)

DATE: 12/2/63

FROM: SAC, Birmingham (157-352) (P)

SUBJECT:

BAPBOMB 42

Rerep SA [REDACTED] 12/1/63, Birmingham.

Enclosed for the Bureau are three copies and for Mobile one copy of an additional administrative page, marked H-1 setting out names of sources of banking information on individuals mentioned in rerep.

This additional page should be inserted after cover page H.

Handwritten mark

2 - Bureau (Enc. 3) ENCLOSURE
1 - Mobile (Enc. 1) DETACHED AND FILED
2 - Birmingham IN SER. 725
FILED
DEC 12 1963

157-1025

NOT RECORDED

3 DEC 4 1961

[REDACTED] cc Orginal

DEC 4 1963
Jain
SIA

COMMUNICATIONS SECTION

64 DEC 15 1963

12/17/63
12/17/63

FEDERAL BUREAU OF INVESTIGATION
DEPARTMENT OF JUSTICE
COMMUNICATIONS SECTION
DEC 17 1963

TELETYPE

Mr. Tolson	
Mr. Belmont	
Mr. Mohr	
Mr. Casper	
Mr. Callahan	
Mr. Conrad	
Mr. DeLoach	
Mr. Evans	
Mr. Gale	
Mr. Rosen	
Mr. Sullivan	
Mr. Tavel	
Mr. Trotter	
Tele. Room	
Miss Holmes	
Miss Gandy	

Rel
Log

URGENT 12-17-63 9-34 PM CST GDM
TO DIRECTOR
FROM SAC, BIRMINGHAM /157-352/ 4P
BAPBOMB DAILY SUMMARY.

670

[REDACTED]

157-1025-75

END PAGE ONE

57 DEC 24 1963
F70

10 DEC 19 1963

6-28

XXXXXX
XXXXXX
XXXXXX

FEDERAL BUREAU OF INVESTIGATION FOIPA DELETED PAGE INFORMATION SHEET

7 Page(s) withheld entirely at this location in the file. One or more of the following statements, where indicated, explain this deletion.

- Deleted under exemption(s) (b)(7)(C) and (D) with no segregable material available for release to you.
- Information pertained only to a third party with no reference to you or the subject of your request.
- Information pertained only to a third party. Your name is listed in the title only.
- Documents originated with another Government agency(ies). These documents were referred to that agency(ies) for review and direct response to you.

_____ Pages contain information furnished by another Government agency(ies). You will be advised by the FBI as to the releasability of this information following our consultation with the other agency(ies).

_____ Page(s) withheld for the following reason(s):

For your information: _____

The following number is to be used for reference regarding these pages:
157-1025-757 p 2 and 3

XXXXXX
XXXXXX
XXXXXX

XXXXXXXXXXXXXXXXXXXXX
X DELETED PAGE(S) X
X NO DUPLICATION FEE X
X FOR THIS PAGE X
XXXXXXXXXXXXXXXXXXXXX

PAGE FOUR

[REDACTED]

EIGHTEEN INTERVIEWS CONDUCTED. ⁶ AMOUT THIRTYONE PENDING.

END AND ACK --

WA 10-49 PM OOK FBI WA LLD

TU CLR

DEC 10 1 03 PM '83

REC'D - CIV RIGHTS

FEDERAL BUREAU OF INVESTIGATION
U. S. DEPARTMENT OF JUSTICE
COMMUNICATIONS SECTION
DEC 18 1963
TELETYPE

Mr. Tolson	_____
Mr. Belmont	_____
Mr. Mohr	_____
Mr. Casper	_____
Mr. Callahan	_____
Mr. Conrad	_____
Mr. DeLoach	_____
Mr. Evans	_____
Mr. Gale	_____
Mr. Rosen	_____
Mr. Sullivan	_____
Mr. Tavel	_____
Mr. Trotter	_____
Tele. Room	_____
Miss Holmes	_____
Miss Gandy	_____

URGENT 12-18-63 9-25 PM CST WCR
TO DIRECTOR /157-1025/
FROM SAC, BIRMINGHAM /157-352/ 3P

BAPBOMB

DAILY SUMMARY.

TO BE RECONTACTED TOMORROW.

ON DECEMBER EIGHTEEN, AUSA R. MACEY TAYLOR ADVISED DURING
MOTIONS HEARD IN DISTRICT COURT, BIRMINGHAM IN CASE INVOLVING

END 66 DEC 26 1963

Handwritten signature

Handwritten 'B-119'

Handwritten '758' and signature

PAGE TWO

10-11

[REDACTED]

[REDACTED] IN VIEW OF PREVIOUS INFO
REGARDING RAMBLER SEEN IN AREA OF CHURCH BOMBING THIS MATTER
WILL BE EXPLORED FULLY.

[REDACTED]

10-11

ENDPAGE TWO

PAGE THREE

6254

[REDACTED]

SIXTEEN INTERVIEWS CONDUCTED. ABOUT TWENTYSEVEN

PENDING.

END AND ACK PLS.

10-32 PM OK FBI WA RL

TU CLEAR

DEC 12 11 03 AM '62

RECEIVED
FBI
WASHINGTON
DEC 12 1962

UNITED STATES GOVERNMENT

Memorandum

TO : DIRECTOR, FBI (157-1025) DATE: 12/4/63
ATTENTION: IDENTIFICATION DIVISION

FROM : SAC, KNOXVILLE (157-189) (P)

SUBJECT: BAPBOMB

Re Bureau airtel to Knoxville and Birmingham
October 25, 1963; Knoxville letter to the Bureau November
5, 1963.

A review of the list of members of the Dixie
Klans, Knights of the Ku Klux Klan, Inc. (DK, KKKK, Inc.)
as compiled from contact with informants, interviews of
reported members through investigation of BAPBOMB and other
investigation in an effort to determine possible suspects
has been completed. In addition to the information sub-
mitted on the six individuals in referenced Knoxville
letter, the following are the names of some of the other
DK, KKKK, members together with available identifying
data.

The Identification Division is requested to
attempt to locate fingerprints of these individuals and
compare their prints, if located, with the latent finger-
prints recovered in connection with the attempted bomb-
ing of the Jewish Temple Bethel, Birmingham, Alabama,
April, 1958.

[REDACTED SECTION]

- 3 - Bureau (Registered Mail)
- 2 - Birmingham (157-352) (Registered Mail)
- 2 - Knoxville

and 12-13-63
RGW: XCN

*4-5-63
12-9-63*

67c

2 d.

[Handwritten initials]

[Handwritten signature]

[Handwritten initials]

*157-191025-759
DEC 5 1963*

[Vertical stamp or markings]

XXXXXX
XXXXXX
XXXXXX

FEDERAL BUREAU OF INVESTIGATION
FOIPA DELETED PAGE INFORMATION SHEET

3 Page(s) withheld entirely at this location in the file. One or more of the following statements, where indicated, explain this deletion.

- Deleted under exemption(s) (b)(7)(C) and (D) with no segregable material available for release to you.
- Information pertained only to a third party with no reference to you or the subject of your request.
- Information pertained only to a third party. Your name is listed in the title only.
- Documents originated with another Government agency(ies). These documents were referred to that agency(ies) for review and direct response to you.

_____ Pages contain information furnished by another Government agency(ies). You will be advised by the FBI as to the releasability of this information following our consultation with the other agency(ies).

_____ Page(s) withheld for the following reason(s):

For your information: _____

The following number is to be used for reference regarding these pages:
157-1025-759 / 2, 3 & 4

XXXXXX
XXXXXX
XXXXXX

XXXXXXXXXXXXXXXXXXXXX
X DELETED PAGE(S) X
X NO DUPLICATION FEE X
X FOR THIS PAGE X
XXXXXXXXXXXXXXXXXXXXX

KX 157-189

[REDACTED]

65c

[REDACTED]

[REDACTED]

The Bureau is requested to furnish the results of the above requested examination to the Birmingham and Knoxville Divisions.

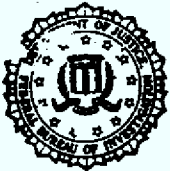

FEDERAL BUREAU OF INVESTIGATION

Washington, D. C. 20537

REPORT

of the

LATENT FINGERPRINT SECTION

Identification Division

YOUR FILE NO. **157-189**
FBI FILE NO. **157-1025-759**
LATENT CASE NO. **45563**

December 13, 1963

TO: **SAC, Knoxville**

RE: **BAPBOMB**

REFERENCE: **Letter 12-4-63**
EXAMINATION REQUESTED BY: **Knoxville**
SPECIMENS:

The latent fingerprints previously developed in the case entitled "Unknown Subject; Attempted Bombing of Temple Beth-El Jewish Synagogue, 21st Way and Highland Avenue, Birmingham, Alabama, 4-28-58," Bufile #100-135-4, are not identical with the fingerprints of the following listed individuals:



MAILED 10
DEC 13 1963
COMM-FBI

- Tolson _____
- Belmont _____
- Mohr _____
- Casper _____
- Callahan _____
- Conrad _____
- DeLoach _____
- Evans _____
- Gale _____
- Rosen _____
- Sullivan _____
- Tavel _____
- Trotter _____
- Tele. Room _____
- Holmes _____
- Gandy _____

1 - Birmingham (157-352)
1 - Bufile (100-135-4)

RGW:hln

(Continued on next page)

John Edgar Hoover, Director

DEC 24 1963

THIS REPORT IS FURNISHED FOR OFFICIAL USE ONLY

MAIL ROOM TELETYPE UNIT

UNRECORDED COPY FILED IN 100-135-4

Handwritten notes and signatures on the left margin.

Handwritten initials 'b7c'.

Handwritten signatures and initials, including 'John Edgar Hoover'.

Handwritten 'F70'.

SAC, Knoxville

December 13, 1963

[REDACTED]

Unable to locate identifiable fingerprint records
for the following listed individuals:

b7c

[REDACTED]

FEDERAL BUREAU OF INVESTIGATION
LATENT FINGERPRINT SECTION WORK SHEET

Recorded: 12-9-63/1:00PM

Reference No: 157-189

Received: 12-9-63/dab

FBI File No: 157-1025-159

Latent Case No: 45563

Answer to: SAC, KNOXVILLE

Examination requested by: Addressee

Copy to: Birmingham ¹⁵⁷⁻³⁵² Bufile 100-135-4

RE: BAPBOMB

Date of reference communication: 12-4-63 letter.

Specimens: Named individuals:

[REDACTED]

Examination by: [REDACTED]
Evidence noted by: [REDACTED]

list to CI - 12-9-63 Cow

The lat facts prev. des in the case "Unknown Subj, Attempted
Bombing of Temple Beth-El Jewish Synagogue, 21 1/2 Way
and Highland Ave, Birmingham, Ala, 4-28-58," Bufile 100-135-4
are not & with the facts of individuals whose names are
preceded by (-) dash - 12-12-63 Cow

and 12-13-63

RGW: Xen

Examination completed:

10:15 AM 12-12-63

Dictated:

12-12-63 Cow

FBI

Date: 12/18/63

Transmit the following in _____
(Type in plain text or code)

Via AIRTEL AIRMAIL
(Priority or Method of Mailing)

TO: Director, FBI (157-1025)
FROM: SAC, Birmingham (157-352)(P)
SUBJECT: UNKNOWN SUBJECTS;
BOMBING OF 16TH STREET BAPTIST CHURCH,
BIRMINGHAM, ALABAMA, 9/15/63
BOMBING MATTERS

h/c

(Copy bomb)

9

Attached are three copies of Index prepared for inclusion in report of SA [redacted] Birmingham, dated 12/1/63. A copy of this index is being sent to the Mobile Office.

Bureau and Mobile please insert index in above report.

- 3-Bureau (Enc. 3)
- 2-Mobile (Enc. 1)
- 2-Birmingham

*1 cc + encl
2 encl detached & filed
in ser 725
1/9/64 msh*

REC-35

157-1025-760

3 ENCLOSURE

1 DEC 19 1963

66 JAN 13 1964

Approved: _____
Special Agent in Charge

Sent _____ M Per _____

[Handwritten signatures and initials]

FBI

Date: 12/16/63

AIRTEL

(Type in plain text or code)

AIRMAIL

(Priority or Method of Mailing)

the following in

TO:

DIRECTOR, FBI

FROM:

SAC, MIAMI (P)

ATTENTION: CIVIL RIGHTS SECTION
GENERAL INVESTIGATIVE DIVISION

BAPBOMB
(OO: BIRMINGHAM)
(Bufile 157-1025)
(Miami 157-876)

852064
ALL INFORMATION CONTAINED
HEREIN IS UNCLASSIFIED
DATE 11/8/84 BY SP8 BTJ/...

(OO: MIAMI)
Miami file 157-918

Re Miami airtel to the Bureau, 12/14/63.

- ⑥ - Bureau (3 - 157-1025) (3 - 157-918) (AM) (RM)
- 3 - Birmingham (2 - 157-352) (1 - 157-918) (AM) (RM)
- 3 - Los Angeles (1 - 157-1025) (1 - 157-918) (AM) (RM)
- 3 - Mobile (2 - 157-876) (1 - 157-BAPBOMB) (AM) (RM)
- 4 - Miami (1 - 157-876) (1 - 157-918)

(19)

REC-45

157-1025-761
DEC 16 1963

66 DEC 26 1963

Approved: [Signature] Special Agent in Charge

Sent

157-1263-

REPRODUCED COPY FILED IN

[Handwritten signature]

FEDERAL BUREAU OF INVESTIGATION
U. S. DEPARTMENT OF JUSTICE
COMMUNICATIONS SECTION

DEC 21 1963

TELETYPE

Mr. Tolson	_____
Mr. Belmont	_____
Mr. Mohr	_____
Mr. Casper	_____
Mr. Callahan	_____
Mr. Conrad	_____
Mr. DeLoach	_____
Mr. Evans	_____
Mr. Gale	_____
Mr. Rosen	_____
Mr. Sullivan	_____
Mr. Tavel	_____
Mr. Trotter	_____
Tele. Room	_____
Miss Holmes	_____
Miss Gandy	_____

URGENT 12-20-63 10-55 PM CST WCR

TO DIRECTOR /157-1025/

FROM SAC, BIRMINGHAM /157-3026

copies made by [handwritten initials] for review by Rowe Task Force
Date 1/11/64

BAPBOMB.

DAILY SUMMARY.

ALA

#47
7/3
#127-163
B

[REDACTED]

ALA

ALA

REC-59

157-1025-763

END PAGE ONE

53 DEC 31 1963

282

ST-104

cc - Gains

Frederick
Cip 09 31

DEC 24 1963

6-M

XXXXXX
XXXXXX
XXXXXX

FEDERAL BUREAU OF INVESTIGATION FOIPA DELETED PAGE INFORMATION SHEET

1 Page(s) withheld entirely at this location in the file. One or more of the following statements, where indicated, explain this deletion.

Deleted under exemption(s) (b)(7)(C) and (D) with no segregable material available for release to you.

Information pertained only to a third party with no reference to you or the subject of your request.

Information pertained only to a third party. Your name is listed in the title only.

Documents originated with another Government agency(ies). These documents were referred to that agency(ies) for review and direct response to you.

_____ Pages contain information furnished by another Government agency(ies). You will be advised by the FBI as to the releasability of this information following our consultation with the other agency(ies).

_____ Page(s) withheld for the following reason(s):

For your information: _____

The following number is to be used for reference regarding these pages:
157-1025-763A

XXXXXX
XXXXXX
XXXXXX

XXXXXXXXXXXXXXXXXXXXX
X DELETED PAGE(S) X
X NO DUPLICATION FEE X
X FOR THIS PAGE X
XXXXXXXXXXXXXXXXXXXXX

PAGE THREE

b7c
b7d

[REDACTED]

FIFTEEN INTERVIEWS CONDUCTED. APPROXIMATELY TWENTY DASH
FOUR PENDING.

END ACK PLS.

12-06 AM OK FBI WA JS

TU CLEAR

UNITED STATES GOVERNMENT

Memorandum

TO : DIRECTOR, FBI (157-1025)

DATE: 12/18/63

FROM : SAC, LOUISVILLE (157-171) *RUC*

SUBJECT: BAPBOMB

[REDACTED]

[REDACTED]

[REDACTED]

[REDACTED]

[REDACTED]

44
67-769

The above information is submitted to the Birmingham Office for any action deemed appropriate.

- 2-Bureau
- 2-Birmingham (157-352)
- 1-Louisville

(5)

REC-13

157-1025-764

DEC 28 1963

Laird
SIA

DEC 28 1963
X-13 PROC.

47-769-10000

XXXXXX
XXXXXX
XXXXXX

FEDERAL BUREAU OF INVESTIGATION FOIPA DELETED PAGE INFORMATION SHEET

2 Page(s) withheld entirely at this location in the file. One or more of the following statements, where indicated, explain this deletion.

Deleted under exemption(s) (b)(1) (b)(7)(C) and (D) with no segregable material available for release to you.

Information pertained only to a third party with no reference to you or the subject of your request.

Information pertained only to a third party. Your name is listed in the title only.

Documents originated with another Government agency(ies). These documents were referred to that agency(ies) for review and direct response to you.

_____ Pages contain information furnished by another Government agency(ies). You will be advised by the FBI as to the releasability of this information following our consultation with the other agency(ies).

_____ Page(s) withheld for the following reason(s):

For your information: _____

The following number is to be used for reference regarding these pages:
157-1025-765 p 2 and 3

XXXXXX
XXXXXX
XXXXXX

XXXXXXXXXXXXXXXXXXXXX
X DELETED PAGE(S) X
X NO DUPLICATION FEE X
X FOR THIS PAGE X
XXXXXXXXXXXXXXXXXXXXX

67-269
D

[REDACTED]

FIVE INTERVIEWS CONDUCTED. ABOUT TWENTY EIGHT REMAINING.

END ACK PLS.

12-32 AM OK FBI WA JS

TU CLEAR

M

FEDERAL BUREAU OF INVESTIGATION
U. S. DEPARTMENT OF JUSTICE
COMMUNICATIONS SECTION

DEC 21 1963

TELETYPE

Mr. Tolson	
Mr. Belmont	
Mr. Mohr	
Mr. Casper	
Mr. Callahan	
Mr. Conrad	
Mr. Felt	
Mr. Gale	
Mr. Rosen	
Mr. Sullivan	
Mr. Tavel	
Mr. Trotter	
Tele. Room	
Miss Holmes	
Miss Gandy	

Handwritten notes:
1/21/64
1/21/64
1/21/64
1/21/64
1/21/64

Handwritten signature: [Signature]

Handwritten signature: [Signature]

URGENT 12-21-63 9-32 PM CST WCR

TO DIRECTOR /157-1025/

FROM SAC, BIRMINGHAM /157-325/ 2P

BAPBOMB.

DAILY SUMMARY.

[REDACTED]

Handwritten: 670-10

Handwritten: 157-1025-166

END PAGE ONE

Handwritten: F-229

58 JAN 1 1964

Handwritten signature: [Signature]

PAGE WO

b7c10

[REDACTED]

SIX INTERVIEWS CONDUCTED. ABOUT TWENTY-FIVE REMAINING.

END ACK PLS.

10-38 PM OK FBI WA OS

TU CLEAR

DEC 31 10 38 PM '63

FBI
RECEIVED

PAGE TWO

NO DISSEMINATION MADE OF THIS INFORMATION.

EIGHT INTERVIEWS CONDUCTED. ABOUT THIRTY PENDING.

END AND ACK

WA 10-56 PM OK FBI WA OS

TU CLRO

DEC 51 1 51 PM '69

FBI
REC'D - CIV RIGHTS

51729

XXXXXX
XXXXXX
XXXXXX

FEDERAL BUREAU OF INVESTIGATION FOIPA DELETED PAGE INFORMATION SHEET

 1 Page(s) withheld entirely at this location in the file. One or more of the following statements, where indicated, explain this deletion.

Deleted under exemption(s) (b)(7)(C) and (D) with no segregable material available for release to you.

Information pertained only to a third party with no reference to you or the subject of your request.

Information pertained only to a third party. Your name is listed in the title only.

Documents originated with another Government agency(ies). These documents were referred to that agency(ies) for review and direct response to you.

 Pages contain information furnished by another Government agency(ies). You will be advised by the FBI as to the releasability of this information following our consultation with the other agency(ies).

 Page(s) withheld for the following reason(s):

For your information: _____

The following number is to be used for reference regarding these pages:
157-1025-768 p 2

XXXXXX
XXXXXX
XXXXXX

XXXXXXXXXXXXXXXXXXXXX
X DELETED PAGE(S) X
X NO DUPLICATION FEE X
X FOR THIS PAGE X
XXXXXXXXXXXXXXXXXXXXX

PAGE THREE

6750

[REDACTED]

TWELVE INTERVIEWS CONDUCTED. APPROXIMATELY TWENTYTHREE
PENDING.

END ACK PLS.

9-05 PM OK FBI WA OS

TUC CLEAR

FBI

Date: 12/23/63

Transmit the following in _____
(Type in plain text or code)

Via AIRTEL AIRMAIL
(Priority or Method of Mailing)

TO: DIRECTOR, FBI (157-1025)

FROM: SAC, MOBILE (157-416)

SUBJECT: BAPBOMB

Reference is made to Charlotte airtel to the Bureau dated 11/5/63, setting forth information concerning

[REDACTED]

Mobile indices concerning [REDACTED] are negative.

Enclosed herewith for the Bureau, Birmingham, and Charlotte are the indicated number of copies of FD-302s reflecting interview with [REDACTED] on 12/12/63, at Montgomery, Alabama.

Inasmuch as the possession of the dynamite on the farm of [REDACTED] is not unusual or illegal, and as the information furnished by [REDACTED] tends to support that furnished by [REDACTED] no other investigation by Mobile is being conducted concerning the possession of dynamite by [REDACTED]

- 3 - Bureau (Enc. 2)
- 2 - Birmingham (157-352) (Enc. 20)
- 1 - Charlotte (Info.) (Enc. 1)
- 2 - Mobile

ENCLOSURE REGISTERED

REC 37 157-1025-769

5 DEC 27 1963

EX-114

5 9 JAN 7 1964
Approved: _____
Special Agent in Charge

Sent _____ M Per _____

5129

t

[Signature]

MO 157-416

Copy of this airtel and FD-302 being furnished
Charlotte for its information inasmuch as additional
investigation may be necessary concerning [REDACTED] in
Spartanburg, S. C

47-19

XXXXXX
XXXXXX
XXXXXX

FEDERAL BUREAU OF INVESTIGATION
FOIPA DELETED PAGE INFORMATION SHEET

2

Page(s) withheld entirely at this location in the file. One or more of the following statements, where indicated, explain this deletion.

Deleted under exemption(s) (b)(7)(C), (b)(7)(D) with no segregable material available for release to you.

Information pertained only to a third party with no reference to you or the subject of your request.

Information pertained only to a third party. Your name is listed in the title only.

Documents originated with another Government agency(ies). These documents were referred to that agency(ies) for review and direct response to you.

_____ Pages contain information furnished by another Government agency(ies). You will be advised by the FBI as to the releasability of this information following our consultation with the other agency(ies).

_____ Page(s) withheld for the following reason(s):

For your information: _____

The following number is to be used for reference regarding these pages:
157-1225-769 encl p 1 & 2

XXXXXX
XXXXXX
XXXXXX

XXXXXXXXXXXXXXXXXXXXX
X DELETED PAGE(S) X
X NO DUPLICATION FEE X
X FOR THIS PAGE X
XXXXXXXXXXXXXXXXXXXXX

FBI

Date: 12/23/63

Transmit the following in _____
(Type in plain text or code)

Via AIRTEL AIRMAIL
(Priority or Method of Mailing)

TO: DIRECTOR, FBI (157-1025)

FROM: SAC, MOBILE (157-416)

SUBJECT: BAPBOMB

Reference is made to report of SA [redacted] dated 12/3/63, Oklahoma City.

Enclosed herewith for Birmingham are 20 copies of insert reflecting investigation at Mobile, Ala., on 12/13/63, regarding [redacted]. Two copies of this insert are furnished to the Bureau for information and two copies to Oklahoma City for information, as it may be necessary to conduct further investigation in the Oklahoma City Division concerning [redacted].

The Montgomery investigation was conducted by S. [redacted]

In addition to the information contained in the insert, on 12/13/63 [redacted]

[Large redacted block of text]

- ENCLOSURE
- 3 - Bureau (Enc. 2) (RM)
 - 2 - Oklahoma City (157-167) (Enc. 2) (RM)
 - 2 - Birmingham (157-352) (Enc. 20) (RM)
 - 2 - Mobile (1 - 157-416)
 - (1 - 76-936)

see Org Unit 157-1025-776

DEC 27 1963

CONSOLIDATION
NO ACT 104

Approved: 153 WCR
Special Agent in Charge

Sent _____ M Per _____

68 FEB 5 1964

120042

FEB 5 - 1964

MO 157-416

It is noted that previous interviews with [REDACTED] and his salesman [REDACTED] were set out in FD-302s in report of SA [REDACTED] dated 10/9/63, Mobile. An FD-302 of additional interview with [REDACTED] on 11/18/63 was furnished to Birmingham by airtel dated 11/19/63.

In referenced report, it is set forth that [REDACTED]

It is further noted that the information contained in the enclosed insert and the information previously submitted in FD-302s as referred to in above report, that [REDACTED] was not at his lot at the time the 1958 Chevrolet was left there and the 1960 Chevrolet taken.

Notification to [REDACTED] concerning the recovery of the 1960 Chevrolet is being reported separately in the case entitled [REDACTED] aka.; EFP; ITSMV

XXXXXX
XXXXXX
XXXXXX

FEDERAL BUREAU OF INVESTIGATION FOIPA DELETED PAGE INFORMATION SHEET

 1 Page(s) withheld entirely at this location in the file. One or more of the following statements, where indicated, explain this deletion.

Deleted under exemption(s) (b)(7)(D) & (D) with no segregable material available for release to you.

Information pertained only to a third party with no reference to you or the subject of your request.

Information pertained only to a third party. Your name is listed in the title only.

Documents originated with another Government agency(ies). These documents were referred to that agency(ies) for review and direct response to you.

 Pages contain information furnished by another Government agency(ies). You will be advised by the FBI as to the releasability of this information following our consultation with the other agency(ies).

 Page(s) withheld for the following reason(s):

For your information: _____

The following number is to be used for reference regarding these pages:
157-1025-770 encl

XXXXXX
XXXXXX
XXXXXX

XXXXXXXXXXXXXXXXXXXXX
X DELETED PAGE(S) X
X NO DUPLICATION FEE X
X FOR THIS PAGE X
XXXXXXXXXXXXXXXXXXXXX

PAGE TWO.

b3
b7C
b7D

[REDACTED]

FOUR INTERVIEWS CONDUCTED. ABOUT TWENTY PENDING.

~~CORR PAGE ONE, LINE 8, WD 7, "SHRAPNEL"~~

END

8-16 PM OK FBI WA OS

TU CLR

DEC 52 3 02 PM '52

LPT
REC'D - [unclear]

PAGE TWO

SIX INTERVIEWS CONDUCTED. ABOUT THIRTY THREE REMAINING.

END AND ACK

WA 8-34 PM OK FBI WA RDR

TU CLR

DEC 28 8 02 AM '83

FBI
REC'D - CIA BOMLS

Mr. Burke Marshall
Assistant Attorney General

Director, FBI

December 26, 1963

- 1 - Mr. Belmont
- 1 - Mr. Rosen
- 1 - Mr. Malley
- 1 - Mr. McGowan
- 1 - Mr. Lavin

for

UNKNOWN SUBJECTS;
BOMBING OF SIXTEENTH
STREET BAPTIST CHURCH
BIRMINGHAM, ALABAMA
SEPTEMBER 15, 1963
BOMBING MATTERS

In connection with our investigation of the bombing of the Sixteenth Street Baptist Church in Birmingham, a source that we have developed who is familiar with Klan activity has advised that feeling is strong against the appointment of Mr. Elijah Hill, a Negro, to the position of Deputy United States Marshal. Our source has indicated that he fears violence may occur since Mr. Hill's name and address were published in local newspapers in Birmingham.

We have advised the Chief of Police of the Birmingham Police Department, Jamie Moore, and Chief Deputy United States Marshal Dan Moore of the above information.

The above information was also telephonically furnished to Mr. David R. Owen of the Civil Rights Division of the Department on December 24, 1963.

DEC 26 12 05 PM '63
REC'D-READING ROOM
FBI

RECEIVED

157-1025-773

19 DEC 27 1963

MAILED 7
DEC 26 1963
COMM-FBI

RBL:nkr
(8) *nkr*

SEE ROSEN TO BELMONT MEMO, 12/24/63, SAME CAPTION,
RBL:nkr.

- Tolson
- Belmont
- Mohr
- Casper
- Callahan
- Conrad
- DeLoach
- Evans
- Gale
- Rosen
- Sullivan
- Tavel
- Trotter
- Tele. Room
- Holmes
- Gandy

com/...

see...

DEC 26 10 28 AM '63

DEC 26 10 28 AM '63

DEC 26 10 28 AM '63

MAIL ROOM TELETYPE UNIT

FEDERAL BUREAU OF INVESTIGATION
U. S. DEPARTMENT OF JUSTICE
COMMUNICATIONS SECTION

DEC 26 1963

TELETYPE

URGENT 12-26-63 10-19 PM CST WCR

TO DIRECTOR /157-1025/

FROM SAC, BIRMINGHAM /157-352/ 2P

BAPBOMB.

DAILY SUMMARY

Mr. Tolson	
Mr. Belmont	
Mr. Mohr	
Mr. Casper	
Mr. Callahan	
Mr. Conrad	
Mr. DeLoach	
Mr. Evans	
Mr. Gale	
Mr. Rosen	
Mr. Sullivan	
Mr. Tavel	
Mr. Trotter	
Tele. Room	
Miss Holmes	
Miss Gandy	

McGowan
T. J. [unclear]

[REDACTED]

END PAGE ONE

REC-25 157-1025-974

DEC 27 1963

CC: Pavin 6-87

60 JAN 2 1964

F229

REC-25

UNITED STATES GOVERNMENT

Memorandum

Tolson	_____
Belmont	_____
Mohr	_____
Casper	_____
Callahan	_____
Conrad	_____
DeLoach	_____
Evans	_____
Gale	_____
Rosen	_____
Sullivan	_____
Tavel	_____
Trotter	_____
Tele. Room	_____
Holmes	_____
Gandy	_____

TO : Mr. Belmont

DATE: December 24, 1963

FROM : A. Rosen

SUBJECT: UNKNOWN SUBJECTS;
BOMBING OF SIXTEENTH
STREET BAPTIST CHURCH
BIRMINGHAM, ALABAMA
SEPTEMBER 15, 1963
BOMBING MATTERS

[REDACTED]

Chief of Police Jamie Moore (NA), Birmingham, Alabama, and Chief Deputy U. S. Marshal Dan Moore have been furnished the above information.

[REDACTED]

ACTION:

The Civil Rights Division of the Department has been advised and confirmation* is being made in writing to Assistant Attorney General Burke Marshall.

attached
EX-115
267
see also

RBL:nkr
(6)

REC-16

157-1025-775
6/2

Enclosure sent 12-26-63

DEC 27 1963

59 JAN 7 1964

XEROX

DEC 30 1963

UNRECORDED COPY FILED IN 77-92953

FEDERAL BUREAU OF INVESTIGATION

REPORTING OFFICE BIRMINGHAM	OFFICE OF ORIGIN BIRMINGHAM	DATE 12/20/63	INVESTIGATIVE PERIOD 11/17 - 12/18/63
TITLE OF CASE UNKNOWN SUBJECTS; BOMBING OF SIXTEENTH STREET BAPTIST CHURCH, BIRMINGHAM, ALABAMA		REPORT MADE BY SA [REDACTED]	TYPED BY etc and as indicated
SEPTEMBER 15, 1963 ALL INFORMATION CONTAINED HEREIN IS UNCLASSIFIED DATE 5-3-86 BY SP4 EHL/OW		CHARACTER OF CASE BOMBING MATTERS	1 copies made 2-21-78 for review at FBIEQ by HSCA re 1-21-78 request (See Bufile #62-117290 dated

REFERENCES: Report of SA [REDACTED] December 1, 1963, at Birmingham, Alabama.

LEADS: *14 copies of pg. 1 + 22-38 to no further info to EP - P - 11/4/64*

An information copy designated for Mobile due to reciprocal interest in Racial and Klan Matters with the Birmingham Division.

ADMINISTRATIVE:

Leads as they have arisen during the period covered in this report have been handled on an expedite basis either locally or by means of interoffice communications. Negative information received as a result thereof is not being set forth in this report. This consists primarily of results of automobile license plate checks and miscellaneous interviews regarding unknown suspects, the reporting of which would be of no benefit in this matter. Material included in this report consists of that which has been typed as of December 18, 1963, but does not reflect all investigation conducted prior to that date. There, of course, is some

APPROVED *[Signature]* SPECIAL AGENT IN CHARGE

COPIES MADE:
 3-Bureau (157-1025)
 1-Mobile (Info)
 4-Birmingham (157-352)
100 Dry Bank

DO NOT WRITE IN SPACES BELOW

57-1025-1776 REC-56
 1 DEC 24 1963
 REC

DISSEMINATION RECORD OF ATTACHED REPORT

AGENCY	<i>Orin</i>	<i>Bank</i>		
REQUEST RECD.				
DATE FWD.	<i>6/26/64</i>			
HOW FWD.	<i>6-94B</i>			
BY	<i>2-11-64</i>	<i>104</i>	<i>not by</i>	

NOTATIONS
McDowell
STATS
RECT

BH 157-352

overlapping of investigative periods reported herein which has occurred prior to submission of the referenced report.

43c
Daily contact has been maintained with [REDACTED] Jefferson County Sheriff's Office, and with [REDACTED] Birmingham Police Department, both of whom are co-operative and vitally interested in the solution of this case.

Frequent contacts have been maintained with informants who have been furnishing reliable information regarding main suspects in this matter.

As has been reported previously, any information developed during the course of this investigation which has any bearing on the shrapnel bombing which occurred at Birmingham on the night of September 25, 1963, is being reported in this file in order to eliminate duplicate reporting.

An index for inclusion in this report will be furnished at a later date.

Almost daily spot surveillances have been conducted of the prime suspects either from their residences to their places of employment, if gainfully employed, or vice versa in order that the activities of those suspects might be known. There have been no instances noted in conducting such surveillances during the period of this report which would reflect any unusual activities on the part of such suspects.

42
An additional suspect, one [REDACTED] has been developed. This individual resides at [REDACTED]

Another suspect has been added [REDACTED] based on information furnished by [REDACTED]

BH 157-352

42c
Suspect, [redacted] a suburb of Birmingham, Alabama, continues to be employed at the [redacted] and works regularly on the 7:00 a.m. to 3:30 p.m. shift.

Suspect [redacted] has recently been employed since December 3, 1963, at the [redacted] a suburb of Birmingham, with working hours of 8:00 a.m. to 4:30 p.m. He is very conscious of any surveillances conducted on him and frequently resorts to tactics while driving to and from work in an effort to determine whether he is being followed.

As of the date of this report, investigative attention is being given to the following of suspects in this matter who are considered main suspects, either as to the instant bombing or to related bombings in the Birmingham area. For ready reference, their addresses and telephone numbers, if subscribed to, are set forth.

NAME, RESIDENCE ADDRESS & TELEPHONE NO.	BIRMINGHAM FILE NO.
1. ROBERT E. CHAMBLISS <i>aka: Robert Chambliss, Bob</i> 2505 - 32nd Avenue, North, Birmingham, Ala. Residence Telephone No. 323-5140	157-390

42 3. [redacted]
[redacted]
157-383

4 [redacted]
[redacted]
157-361

BH 157-352

b7c
11. [REDACTED]

12. [REDACTED]

b7c
On December 6, 1963, a conference was had by Special Agent in Charge, RAY L. FAISST, Assistant Special Agent in Charge ROBERT G. JENSEN, and Agents assigned to this matter with [REDACTED] Jefferson County Sheriff's Office. At that time, [REDACTED] advised that he was endeavoring to develop a new source of information regarding the CHAMBLISS group of suspects. Although [REDACTED] did not at that time desire to reveal the identity of this new source of information, it is believed that the source may either be [REDACTED]

[REDACTED]

UNITED STATES DEPARTMENT OF JUSTICE
FEDERAL BUREAU OF INVESTIGATION

247,392
ALL INFORMATION CONTAINED
HEREIN IS UNCLASSIFIED
DATE 3-5-86 BY SP4 EHL/BN

Copy to: *53*

Report of: SA [REDACTED]
Date: 12/20/63

Office: Birmingham

Field Office File #: BH 157-352

Bureau File #: 157-1025

Title: UNKNOWN SUBJECTS;
BOMBING OF THE SIXTEENTH STREET BAPTIST CHURCH
BIRMINGHAM, ALABAMA, SEPTEMBER 15, 1963

Character: BOMBING MATTERS

Synopsis: Continued investigation of activities of suspects in this matter unproductive as to securing positive evidence implicating them in instant bombing or related ones in Birmingham area. Additional relatives and in-laws interviewed and unable to furnish information of value regarding main suspects. Further efforts to identify source of 1940 - 1942 HUDSON clutch plate used in "shrapnel" bomb unproductive. All officers, Birmingham Police Department, who had worked in area of instant bombing throughout evening prior thereto, and on morning of, interviewed without positive information being received.

[REDACTED]

157-352-1-D

XEROX
JUL 13 1964

BH 157-352

[REDACTED]

Further interviews of former and present Klan members in Birmingham and Tuscaloosa areas conducted without positive results. INVESTIGATION REFLECTS MANY MEMBERS OF KLAN AND SEGREGATION-TYPE GROUPS CARRY SOME TYPE OF WEAPON. ALL SUCH INDIVIDUALS ARE, THEREFORE, TO BE CONSIDERED ARMED AND EXTREMELY DANGEROUS.

- P -

DETAILS:

BH 157-352

TABLE OF CONTENTS

ADMINISTRATIVE -----	COVER PAGES "A" - "G"
INFORMANTS-----	COVER PAGES "H" - "S"
INVESTIGATION REGARDING 1940 - 1942 HUDSON CLUTCH PLATE USED IN SHRAPNEL BOMBING -----	PAGES 4 - 11
<u>SUSPECTS:</u>	
	PAGES
[REDACTED] -----	41; 50 - 52
[REDACTED] -----	13 - 21
ROBERT E. CHAMBLISS -----	4 - 12; 41
[REDACTED] -----	39 - 43
[REDACTED] -----	22 - 38
[REDACTED] -----	41; 44-47
[REDACTED] -----	53 - 57
[REDACTED] -----	41
[REDACTED] -----	58 - 66
[REDACTED] -----	41
[REDACTED] -----	48 - 49
KLAN MEMBERS, BIRMINGHAM, ALABAMA, AREA -----	67 - 82
KLAN MEMBERS, TUSCALOOSA, ALABAMA, AREA -----	83 - 99
KLAN MEMBERS, BESSEMER AREA -----	100 - 119
KLAN MEMBERS, WARRIOR AREA -----	120 - 121
NATIONAL STATES RIGHTS PARTY -----	122 - 124
BIRMINGHAM POLICE DEPARTMENT OFFICERS ON DUTY NIGHT PREVIOUS AND MORNING OF BOMBING -----	125 - 143
OBSERVATIONS OF [REDACTED] -----	
[REDACTED] -----	144 - 146
BIRMINGHAM POLICE DEPARTMENT OFFICERS ON DUTY TIME OF SHRAPNEL BOMB, SEPTEMBER 25, 1963 -----	147
NEIGHBORHOOD -----	148 - 150

1

MO 157-416

BH 157-352

fc

The following investigation was conducted by SAS
[redacted] and [redacted] on November 7, 1963:

A search of the City Dump, Tallassee, Alabama,
failed to locate a wet type clutch plate for a Hudson
automobile.

[redacted]

[redacted]

[redacted]

b7c 1A

XXXXXX
XXXXXX
XXXXXX

FEDERAL BUREAU OF INVESTIGATION
FOIPA DELETED PAGE INFORMATION SHEET

161

Page(s) withheld entirely at this location in the file. One or more of the following statements, where indicated, explain this deletion.

Deleted under exemption(s) (b) (6), (b) (7) (C) and (D) with no segregable material available for release to you.

Information pertained only to a third party with no reference to you or the subject of your request.

Information pertained only to a third party. Your name is listed in the title only.

Documents originated with another Government agency(ies). These documents were referred to that agency(ies) for review and direct response to you.

_____ Pages contain information furnished by another Government agency(ies). You will be advised by the FBI as to the releasability of this information following our consultation with the other agency(ies).

_____ Page(s) withheld for the following reason(s):

For your information: _____

The following number is to be used for reference regarding these pages:
157-1025-776

XXXXXX
XXXXXX
XXXXXX

XXXXXXXXXXXXXXXXXXXXX
X DELETED PAGE(S) X
X NO DUPLICATION FEE X
X FOR THIS PAGE X
XXXXXXXXXXXXXXXXXXXXX