

THIS FILE IS MADE AVAILABLE THROUGH THE DECLASSIFICATION EFFORTS AND RESEARCH OF:

# THE BLACK VAULT

THE BLACK VAULT IS THE LARGEST ONLINE FREEDOM OF INFORMATION ACT / GOVERNMENT RECORD CLEARING HOUSE IN THE WORLD. THE RESEARCH EFFORTS HERE ARE RESPONSIBLE FOR THE DECLASSIFICATION OF THOUSANDS OF DOCUMENTS THROUGHOUT THE U.S. GOVERNMENT, AND ALL CAN BE DOWNLOADED BY VISITING:

[HTTP://WWW.BLACKVAULT.COM](http://www.blackvault.com)

YOU ARE ENCOURAGED TO FORWARD THIS DOCUMENT TO YOUR FRIENDS, BUT PLEASE KEEP THIS IDENTIFYING IMAGE AT THE TOP OF THE .PDF SO OTHERS CAN DOWNLOAD MORE!

23 MAR 1994

Ref: 93-F-0479

Mr. Mark A. Sauter  
American Journal  
402 East 76th Street  
New York, NY 10021

Dear Mr. Sauter:

This responds to your September 26 1993, Freedom of Information Act (FOIA) request pertaining to live-fire tests on the C-17 cargo plane. The Air Force referred your request to this Directorate, along with records under Office of the Secretary of Defense cognizance. Our February 22 interim response refers.

The enclosed records are provided as responsive to your request. There are no chargeable costs associated with processing this request in this instance.

Sincerely,

**SIGNED**

W. M. McDonald  
Director  
Freedom of Information  
and Security Review

Enclosures

FOI:Kahn:gvk:4F0379L1:03/23/94:gr✓pk\_y1\_wh\_

*RR 10/15*

*940323  
jm*

*#589*



# C-17 FLIGHT TEST PROGRAM

#589

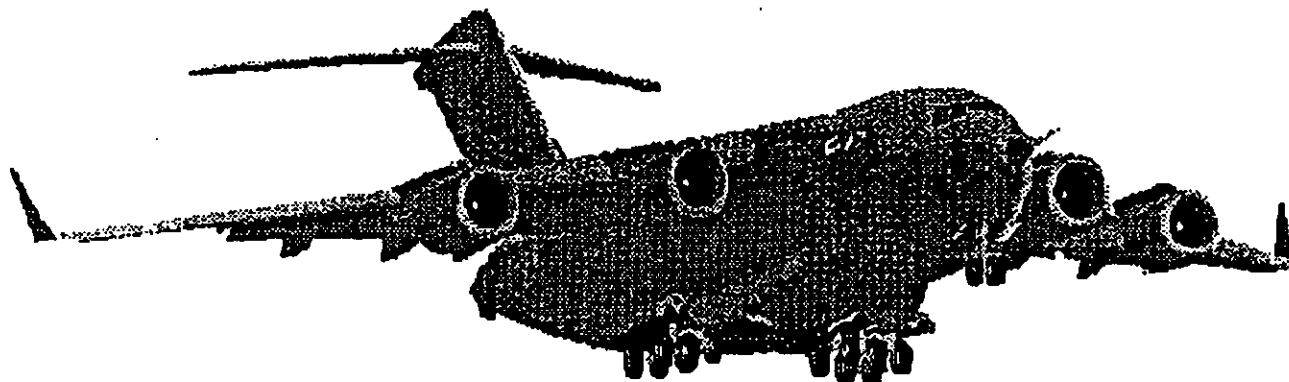

**DECISION BRIEF TO PEO  
ON  
USING STATIC WING ARTICLE  
FOR  
LIVE FIRE TEST**

**20 OCT 93**



## **LFT TEAM MEMBERS**

**YCA - CAPT MATEOS**

**YCD - LT BARNES**

**YCE - MR DOW, MR DOWEL, MR CONDRON**

**YCF - MS MATTEIS**

**YCK - MS GRIFFITH**

**YCL - LT COL BURKE**

**YCT - MAJ GUZOWSKI**

**YCS - CAPT GORMAN**

**WL/FIVS - MR MURPHY, MR LAUZZE**

**PLUS: MDA (WEST) COUNTERPARTS**

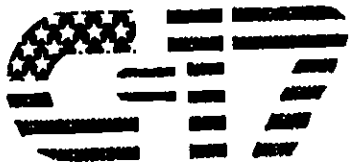

# **LIVE FIRE TEST (LFT) THE LAW**

- **SECTION 2366, TITLE 10 REQUIRES SURVIVABILITY TEST OF COVERED SYSTEM PRIOR TO MSIII**
- **FY 93 AUTHORIZATION ACT SPECIFIED C-17 AS COVERED SYSTEM**
- **SECDEF MAY WAIVE "FULL UP TEST"**
- **SECDEF MUST CERTIFY TO CONGRESS IT IS UNREASONABLY EXPENSIVE**
- **ALTERNATE STRATEGY TO EVALUATE VULNERABILITY MUST BE IN WAIVER PACKAGE**

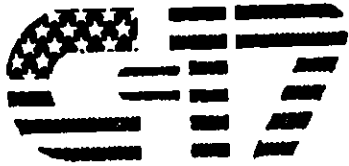

## **LFT DEFINITIONS**

### **1. REALISTIC SURVIVABILITY TESTING:**

**“... TESTING FOR VULNERABILITY AND SURVIVABILITY OF THE SYSTEM IN COMBAT BY FIRING MUNITIONS LIKELY TO BE ENCOUNTERED IN COMBAT AT THE SYSTEM CONFIGURED FOR COMBAT, WITH THE PRIMARY EMPHASIS ON TESTING VULNERABILITY WITH RESPECT TO POTENTIAL USER CASUALTIES AND TAKING INTO EQUAL CONSIDERATION THE OPERATIONAL REQUIREMENTS AND COMBAT PERFORMANCE OF THE SYSTEM.”**

**2. CONFIGURED FOR COMBAT: “... LOADED OR EQUIPPED WITH ALL DANGEROUS MATERIALS (INCLUDING ALL FLAMMABLES AND EXPLOSIVES) THAT WOULD NORMALLY BE ON BOARD IN COMBAT”**

**SOURCE: SECTION 2366, TITLE 10, US CODE**

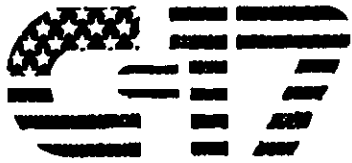

## **C-17 LFT DIRECTION**

**28 DEC 92 - OSD LETTER TO SAF/AQ DIRECTING TEST OF  
"PRODUCTION REPRESENTATIVE WINGS" VS 14.5mm API & HEI  
AND 12.7mm API & HEI**

**29 APR 93 - C-17 TEMP APPROVED BY OSD THAT INCLUDED A  
REVISED APPENDIX F, "C-17 SURVIVABILITY TESTING," WHICH  
INCORPORATED DIRECTION FROM 28 DEC 92 OSD LETTER.**

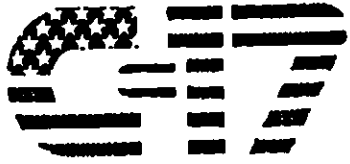

## **LIVE FIRE TEST (LFT) OSD POSITION**

- EVALUATE EFFECTS OF HYDRODYNAMIC RAM**
- CONFIRM FUEL TANK INERTING AND OTHER FIXES**
- EVALUATE VULNERABILITY OF WING PYLON**
- EVALUATE SURVIVABILITY OF INTEGRATED WING SYSTEMS**
- CONFIRM LEADING EDGE DRY BAY RESULTS**
- INVESTIGATE TRAILING EDGE DRY BAY VULNERABILITY**



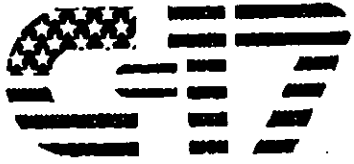

## **LFT WAIVER PROCESS**

- 1. AGREEMENT REACHED ON DISPOSITION OF  
"PRODUCTION REPRESENTATIVE" WING REQUIREMENT  
FROM 28 DEC 92 FRASER LETTER**
- 2. AF RESUBMITS WAIVER PACKAGE TO CSD IF CHANGES  
ARE REQUIRED**
- 3. SECDEF APPROVES WAIVER & CERTIFIES TO CONGRESS  
THAT FULL-UP TESTING OF A COMPLETE C-17 IS  
UNREASONABLY EXPENSIVE AND IMPRACTICAL**

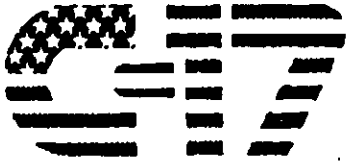

# **C-17 OMNIBUS SETTLEMENT LANGUAGE FOR LFT**

- **UNDER SECRETARY OF DEFENSE FOR ACQUISITION TO:**
  - **INITIATE WAIVER FOR STATUTORY REQUIREMENT FOR LFT OF C-17**
  - **ADDITIONALLY, ALTERNATIVE LFT STRATEGY FOR TESTING PRODUCTION REPRESENTATIVE C-17 WING IS UNDER REVIEW**



# LIVE FIRE TEST SPECTRUM

ISSUES	THREAT CLASSES				
	MANPAD, OTHER IR SAMS	AAA PROJECTILES, SMALL ARMS, AUTOMATIC WEAPONS	FAE	LOW POWER LASER	MED/HIGH POWER LASER
FUEL SYSTEM DRY BAY FIRE	ANALYSIS  BASED  ON  PAST  TESTS  AND  25 VVA	BALLISTIC TEST IN WLE ARTICLE			
ULLAGE		OBIGGS TESTS (OTIS IN PROGRESS)			
RAM INDUCED STRUCTURAL FAILURE		BALLISTIC TEST ON C-17A STATIC WING			
PROPULSION FIRE		DEMONSTRATION (FIRE BOTTLE OTIS)			
UNCONTAINED FAILURE		ANALYSIS BASED ON 25VVA (AVS 8711151)			
ENGINE-FLAP SYNERGISM		ANALYSIS BASED ON PAST TEST COMPLETED (MDC REPORT K4497) (FLYING QUALITIES)			
FLIGHT CONTROLS SEPARATION		DEMONSTRATION COMPLETED (MDC REPORT K4497)			
DEGRADATION		ANALYSIS TESTS AS REQUIRED COMPLETED 25VVA (MDC REPORT 1926) (VULNERABILITY ASSESSMENT REPORTS)			
STRUCTURE/CONTROL SURFACES (COMPOSITE)		ANALYSIS (ASGXRESV)			
USER CASUALTIES		AND			
CARGO	ANALYSIS (ASGXRESV)			NOT APPLICABLE	
DELIVERY AREA	ANALYSIS (25VVA)				
UNIDENTIFIED	ANALYSIS (25VVA)				

THESE ISSUES GENERALLY  
NOT APPLICABLE TO  
THESE THREATS.  
PERTINENT ISSUES NEED  
TO BE IDENTIFIED

\$ SPENT ON ANALYSIS AND QUALIFICATION TESTING \$7.5M

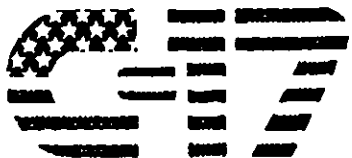

# BALLISTIC TESTS ACCOMPLISHED

TEST ARTICLE	THREAT (SMALL ARMS & AAA)							
	DIRECTED BY DR FRASER				OPTIONAL		IDA SUGGESTED	
	12.7 MM		14.5 MM		23 MM		30MM	
	API	HEI	API	HEI	API	HEI	API	HEI
COMPOSITE PANEL	DEC 92	PLANNED ROUNDS NOT AVAILABLE		JUN 93		JUN 93		
COMPONENT LFTS: OBIGGS/BOTTLE CREW ARMOR FLAP HINGE, RAMP ACCUMLATOR UPPER WING SKIN FIREX BOTTLE	NOV 91 FEB 89 OCT 88 FEB 92 NOV 92 ON GOING							
C-130 FUEL TANK						MAR 93		
B-707 FUEL TANK						APR 93		
WING LEADING EDGE ARTICLE	SEP 93	PLANNED ROUNDS NOT AVAILABLE		OCT 93		OCT 93		
STATIC WING TEST ARTICLE								

\$ SPENT ON BALLISTIC TESTS \$4.5M  
TOTAL SPENT TO DATE ON LFT \$12M

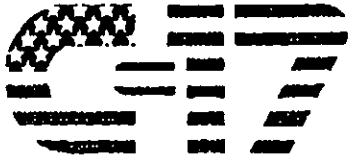

## **TEST CONCEPT OF OPERATIONS**

- **OBTAIN MOA'S WITH WRIGHT LABS, 4950TH & CHINA LAKE**
  - **DETERMINE RESPONSIBILITIES**
  - **ENSURE TEST RANGES ARE AVAILABLE/CAPABLE**
- **DEVELOP TEST PLANS**
  - **DETERMINE SHOT LINES, LOCATIONS AND PRIORITIES**
    - » **DEVELOP CONTINGENCY PLANS**
- **INITIATE TEST ARTICLE DESIGN**
- **ASSESS STATIC ARTICLE**
  - **ASSEMBLY INDEPENDENT TEAM TO DETERMINE**
    - » **STATIC WING SUITABILITY FOR TEST**
    - » **MODIFICATIONS FOR PRODUCTION REPRESENTATIVE CONFIGURATION**
- **DISASSEMBLE WING FROM STATIC FIXTURE**
- **SHIP STATIC ARTICLE TO REFURISH/TEST SITES**

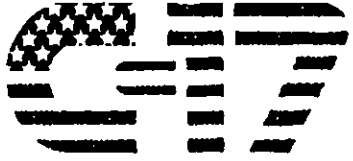

## **TEST CONCEPT OF OPERATIONS (CON'T)**

- **ORDER TEST ARTICLE COMPONENTS AND MATERIALS**
- **FABRICATE UNIQUE PARTS**
- **INSTALL COMPONENTS & PARTS AND REFURBISH TEST ARTICLE**
- **PROCURE LFT 12.7MM AND 14.5MM AMMUNITION**
- **TRANSPORT TEST ARTICLE TO TEST FIXTURE**
- **CONDUCT TEST SHOTS**
  - **ASSUMES**
    - » **8 SHOTS PER ARTICLE**
    - » **ARTICLES TO BE REFURBISHED BETWEEN SHOTS UNTIL UNREPAIRABLE**
- **DISPOSAL OF TEST ARTICLE**
- **REDUCE DATA AND WRITE REPORTS**
- **FEEDBACK TEST RESULTS TO DESIGN ENGINEERS AS REQUIRED**

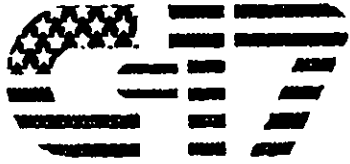

## STATIC ARTICLE LFT OPTIONS

- TEST PLAN IS TO PRIMARILY USE RIGHT WING WITH LEFT WING AS A POTENTIAL BACKUP
  - 1A - #3 INBOARD TANK, SEAL TANK, NO SYSTEMS
  - 1B - #3 AND #4 TANKS, SEAL TANKS, NO SYSTEMS
  - 2A - #3 INBOARD TANK WITH INTERNAL SYSTEMS
    - » COMPONENTS - NORMAL LEAD TIME & ROB FROM PRODUCTION
  - 2B - #3 AND #4 TANKS WITH INTERNAL SYSTEMS
    - » COMPONENTS - NORMAL LEAD TIME & ROB FROM PRODUCTION
  - 3A - #3 TANK WITH INTERNAL AND TRAILING EDGE SYSTEMS
  - 3B - TWO TEST ARTICLES: RAM TEST ARTICLE AND TANK WITH TRAILING EDGE SYSTEMS
    - » COMPONENTS - NORMAL LEAD TIME & ROB FROM PRODUCTION
- 4 - TWO TEST ARTICLES: RAM TEST ARTICLE AND TANK WITH LEADING AND TRAILING EDGE SYSTEMS
- 5 - RIGHT HAND WING WITH ALL SYSTEMS & 1 ENGINE PYLON

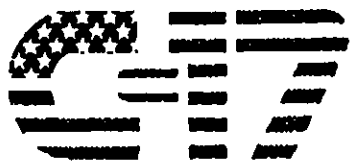

# STATIC WING LET ARTICLE OPTION 1A

- RAM TEST #3 TANK  
-TANK TO BE SEALED

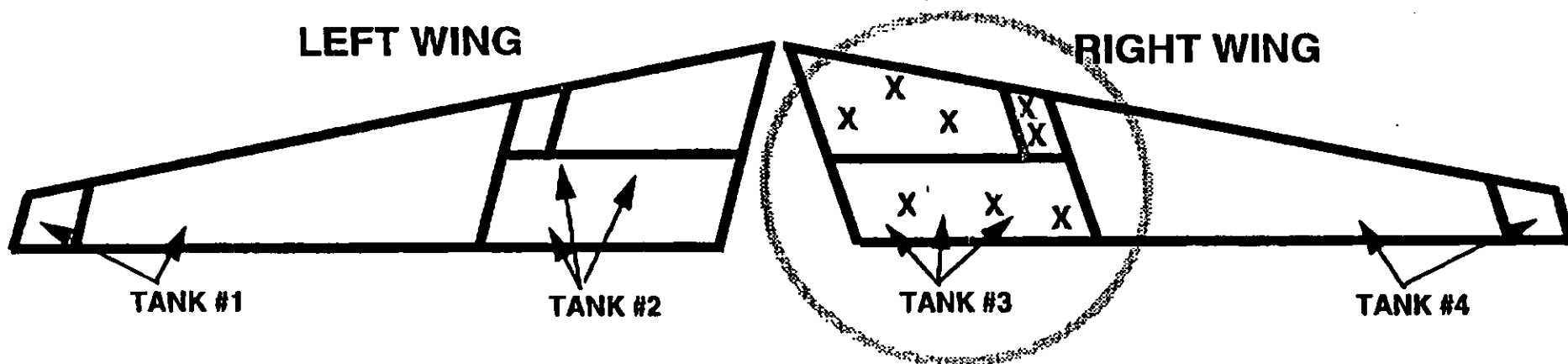

X - PROPOSED SHOT LOCATIONS



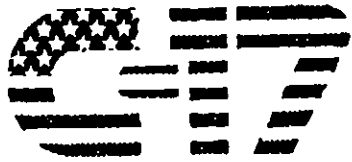

# STATIC WING LFT ARTICLE OPTION 1B

- RAM TEST #3 & #4 TANKS  
- TANKS TO BE SEALED

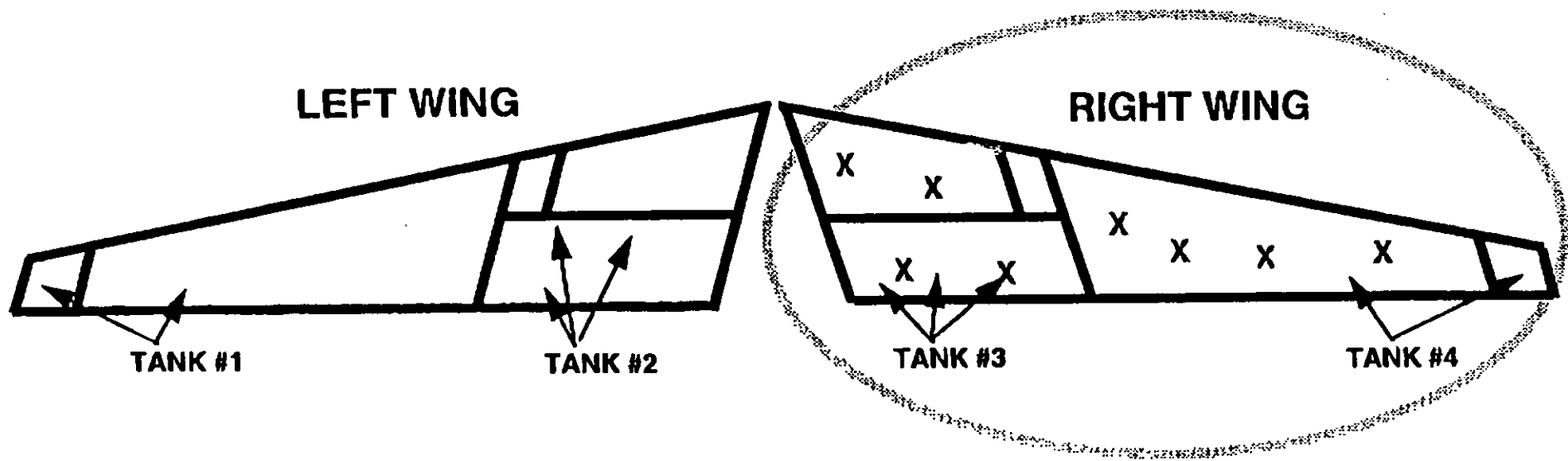

X - PROPOSED SHOT LOCATIONS

OCT 20 '93 11:58AM



# STATIC WING LEFT ARTICLE OPTION 2A

OCT 20 '93 11:30AM

- RAM TEST #3 TANK
  - INTERNAL SYSTEMS INSTALLED
  - TANK SEALED

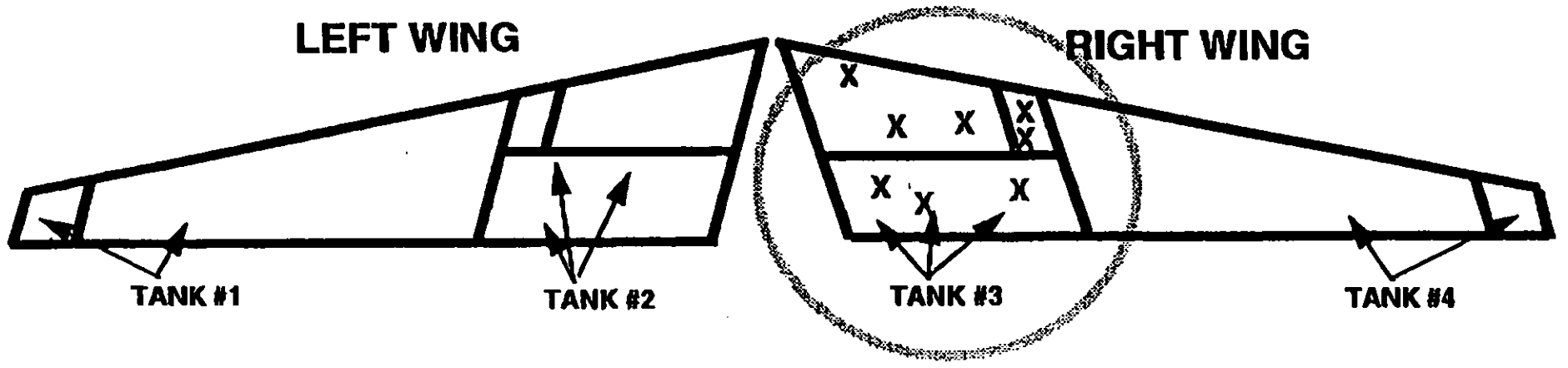

X - PROPOSED SHOT LOCATIONS

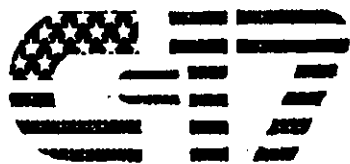

# STATIC WING LFT ARTICLE OPTION 2B

OCT 20 '93 11:30AM

- RAM TEST #3 & #4 TANKS
  - INTERNAL SYSTEMS INSTALLED
  - TANKS SEALED

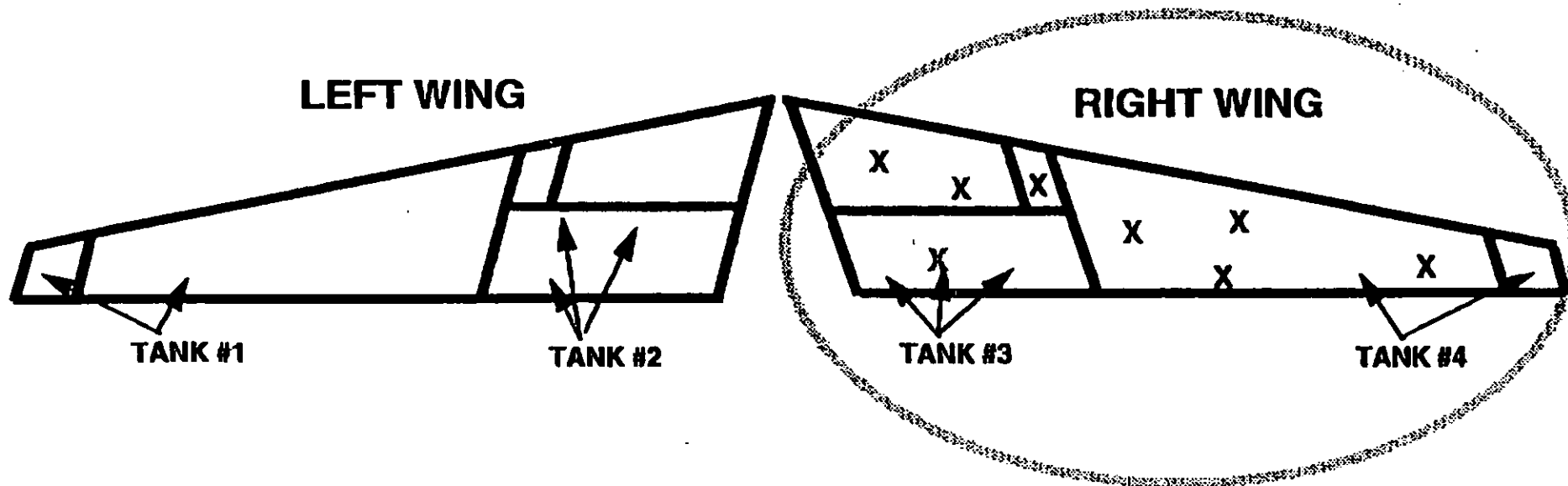

X - PROPOSED SHOT LOCATIONS



# STATIC WING LET ARTICLE OPTION 3A

OCT 20 '93 11:31AM

- **RAM AND TE TESTING**
  - #3 TANK WITH INTERNAL AND TRAILING EDGE SYSTEMS
  - TANK SEALED

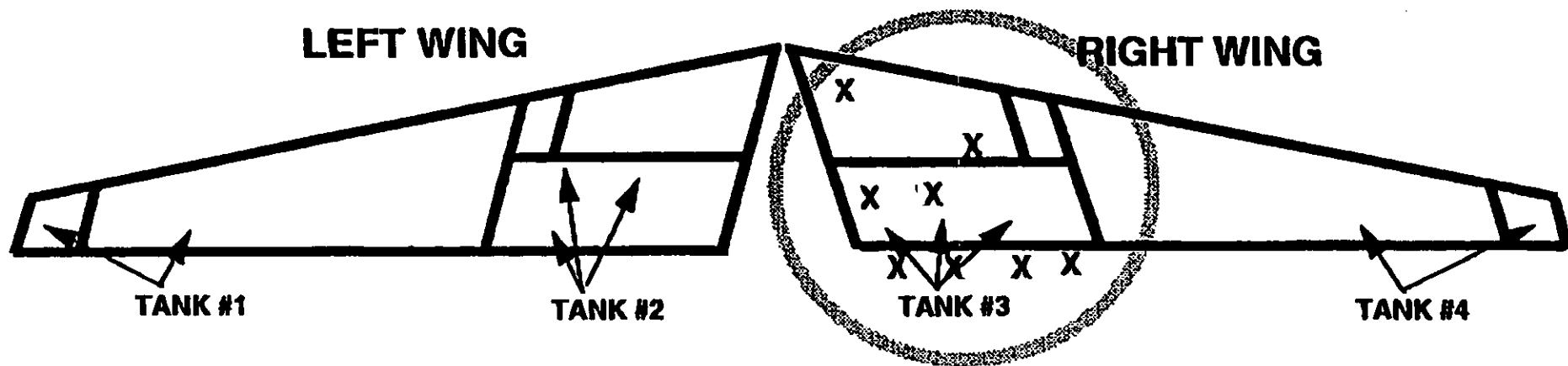

X - PROPOSED SHOT LOCATIONS

P.4

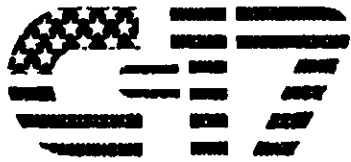

# STATIC WING LEFT ARTICLE OPTION 3B

## TWO TEST ARTICLES

- TE SYSTEMS TEST #2 TANK
- TE SYSTEMS INSTALLED

- RAM TEST #3 TANK
- INTERNAL SYSTEMS INSTALLED
- TANK SEALED

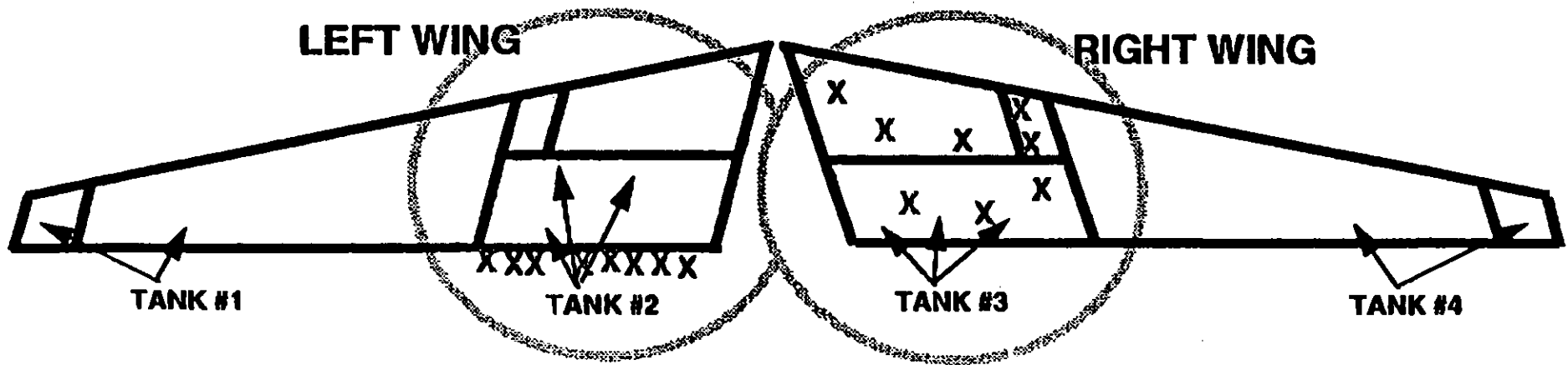

X - PROPOSED SHOT LOCATIONS

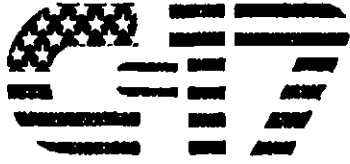

# STATIC WING LEFT ARTICLE OPTION 4

OCT 20 '93 11:32AM

## TWO TEST ARTICLES

- LE & TE SYSTEMS TEST #2 TANK
  - LE & TE SYSTEMS INSTALLED

- RAM TEST #3 TANK
  - INTERNAL SYSTEMS INSTALLED
  - TANK SEALED

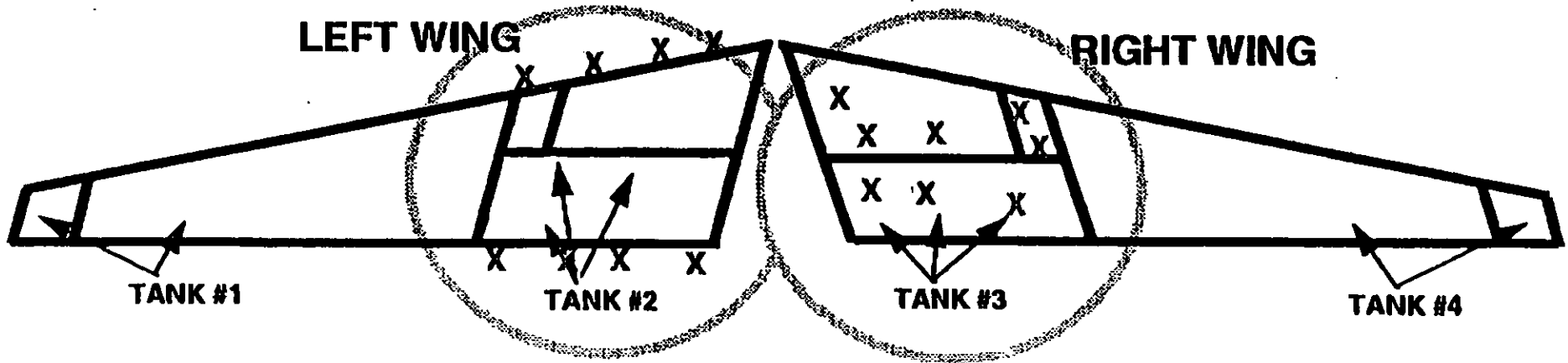

X - PROPOSED SHOT LOCATIONS

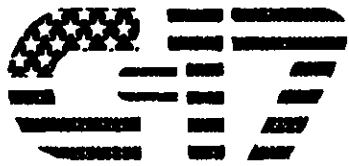

# STATIC WING LEFT ARTICLE OPTION 5

OCT 20 '93 11:33AM

- RAM TEST #3 & #4 TANKS
  - ALL INTERNAL SYSTEMS INSTALLED
  - TANKS SEALED
- LE/TE TESTING
  - ALL LE & TE SYSTEMS INSTALLED
- ENGINE PYLON TESTING
  - ONE PYLON INSTALLED

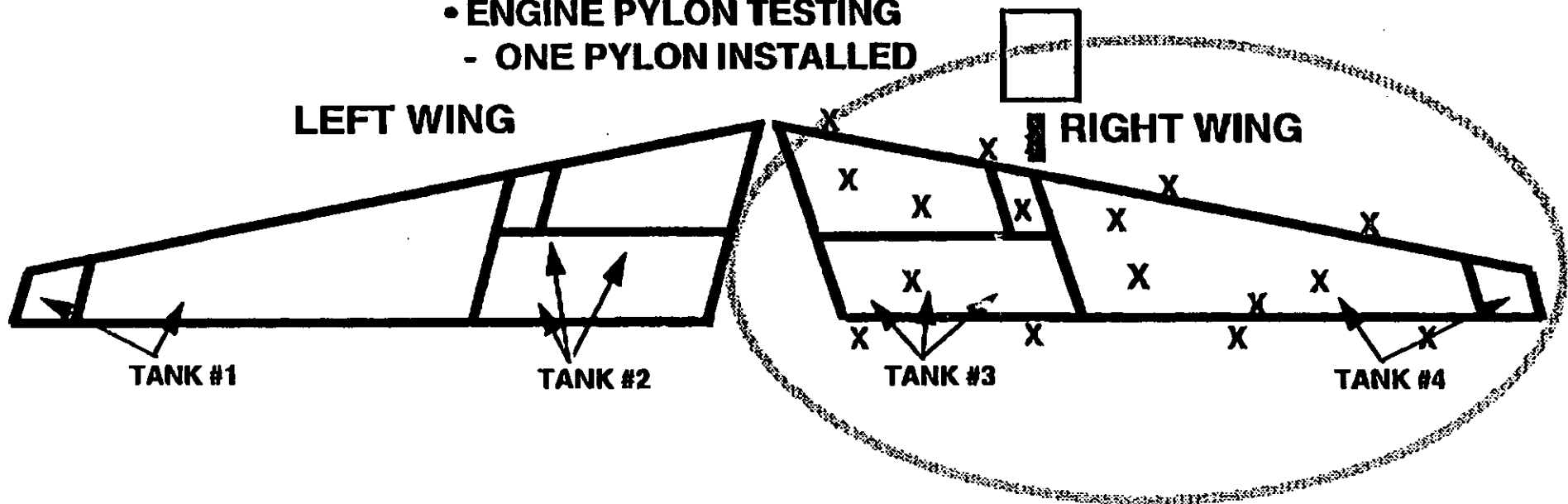

X - PROPOSED SHOT LOCATIONS

P.7

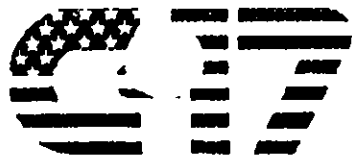

# PROPOSED STATIC ARTICLE LET DEMONSTRATIONS

UNCLASSIFIED

OPTIONS		THREAT (SMALL ARMS & AAA)							
		12.7 MM		14.5 MM		23 MM		30 MM	
		API	HEI	API	HEI	API	HEI	API	HEI
1A - TANK #3 RAM	<b>RAM</b>	X	X	X	X				
1B - TANKS #3 & #4 RAM									
2A - TANK #3 WITH INTERNAL SYSTEMS									
2B - TANKS #3 & #4 WITH INTERNAL SYSTEMS									
3A - TANK #3 WITH INTERNAL & TE SYSTEMS		X	X	X	X				
3B - TWO TEST ARTICLES	<b>RAM &amp; TE</b>	X	X	X	X				
A) RAM									
B) TE SYSTEMS									
4 - TWO TEST ARTICLES		X	X	X	X				
A) RAM	<b>RAM - TE &amp; LE</b>	X	X	X	X				
B) TE & LE SYSTEMS		X	X	X	X				
5 - RH WING WITH ALL SYSTEMS & 1 PYLON		X	X	X	X				
	<b>FULL SPECTRUM</b>	X	X	X	X				
		X	X	X	X				
		X	X	X	X				

X - TEST TO BE PERFORMED



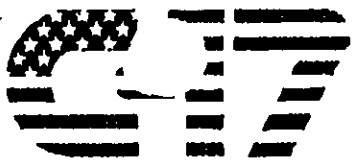

# PROPOSED STATIC ARTICLE LFT DEMONSTRATIONS

OCT 20 11:34AM

THREAT (SMALL ARMS & AAA)								
OPTIONS		12.7 MM		14.5 MM		COST		% PROD REPRESENT
		API	HEI	API	HEI	OPT	TY\$(M)	
1A - TANK #3 RAM	<b>RAM</b>	X	X	X	X	1A	2.01	70
1B - TANKS #3 & #4 RAM		A	A	A	A	1B	3.05	75
2A - TANK #3 WITH INTERNAL SYSTEMS		WLE	A	A	WLE	2A	2.27	78
2B - TANKS #3 & #4 WITH INTERNAL SYSTEMS		A	A	A	A	2B	4.43	85
3A - TANK #3 WITH INTERNAL & TE SYSTEMS		X	X	X	X	3A	6.82	88
3B - TWO TEST ARTICLES	<b>RAM &amp; TE</b>	X	X	X	X	3B	8.26	88
A) RAM		WLE	A	A	WLE			
B) TE SYSTEMS		A	A	A	A			
4 - TWO TEST ARTICLES		X	X	X	X	4	9.25	90
A) RAM	<b>RAM + TE &amp; LE</b>	X	X	X	X			
B) TE & LE SYSTEMS		X	X	X	X			
		A	A	A	A			
5 - RH WING WITH ALL SYSTEMS & 1 PYLON		X	X	X	X	5	15.71	95
	<b>FULL SPECTRUM</b>	X	X	X	X			
		X	X	X	X			
		X	X	X	X			

X - TEST TO BE PERFORMED

A - ANALYSIS

WLE - WING LEADING EDGE ARTICLE TESTS

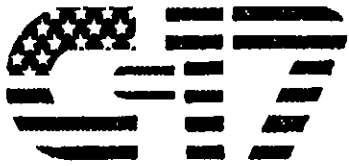

# **LIVE FIRE TEST (LFT) STATIC ARTICLE**

- LEFT WING DAMAGED DURING 2ND STATIC WING FAILURE**
  
- FURTHER TESTING ON STATIC ARTICLE IS REQUIRED**
  - MAX WING DOWN BENDING**
  - MAX PYLON LATERAL GUST LOAD**
  - BRAKED TURN DURING TAXI**
  
- CONDITION OF STATIC ARTICLE WILL NOT BE KNOWN UNTIL APR 94.**
  
- ADDITIONAL TESTING ON STATIC ARTICLE MAY BE REQUIRED BY DOD**
  - PENDING INDEPENDENT REVIEW TEAM FINDINGS**
  
- ARTICLE IS PRODUCTION REPRESENTATIVE FOR PLANNED SHOT LINES**

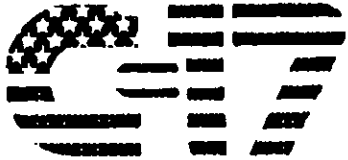

# STATIC WING LFT STRATEGY ASSUMPTIONS

1. **STATIC WING ARTICLE USEABLE IN POST STATIC TEST CONDITION**
  - WING WILL BE AVAILABLE 1 APR 94
2. **GOVERNMENT FACILITIES/SUPPORT AVAILABLE AND USED TO MAX EXTENT**
  - 4950TH MOD CENTER REFURBISH WING
  - CHINA LAKE/WL LIVE FIRE FACILITIES CAN SUPPORT THE SCHEDULE
3. **COMPLETED WLE ARTICLE DRY BAY LF AND COMPONENT TESTING DATA ACCEPTABLE**
4. **TANK INERTING CAPABILITY VERIFIED BY OBIGGS DT&E**
5. **TANK INERTED TO SIMULATE OPERATIONAL OBIGGS**
6. **WING PYLON EVALUATED BY ANALYSIS ON ALL BUT OPTION 5**
7. **SCHEDULES ASSUME NORMAL LEAD TIME FOR PARTS/COMPONENTS AS WELL AS ROBBING FROM PRODUCTION LINE**
8. **FY 94/95 FUNDING PROFILES WILL REQUIRE REPROGRAMMING WITH SOME OPTIONS**
9. **COSTS REFLECT OVERTIME FUNDING TO ENSURE SCHEDULE**

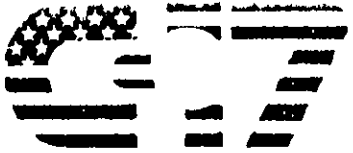

# LET OPTION COMPARISON

OCT 20 '93 11:36AM

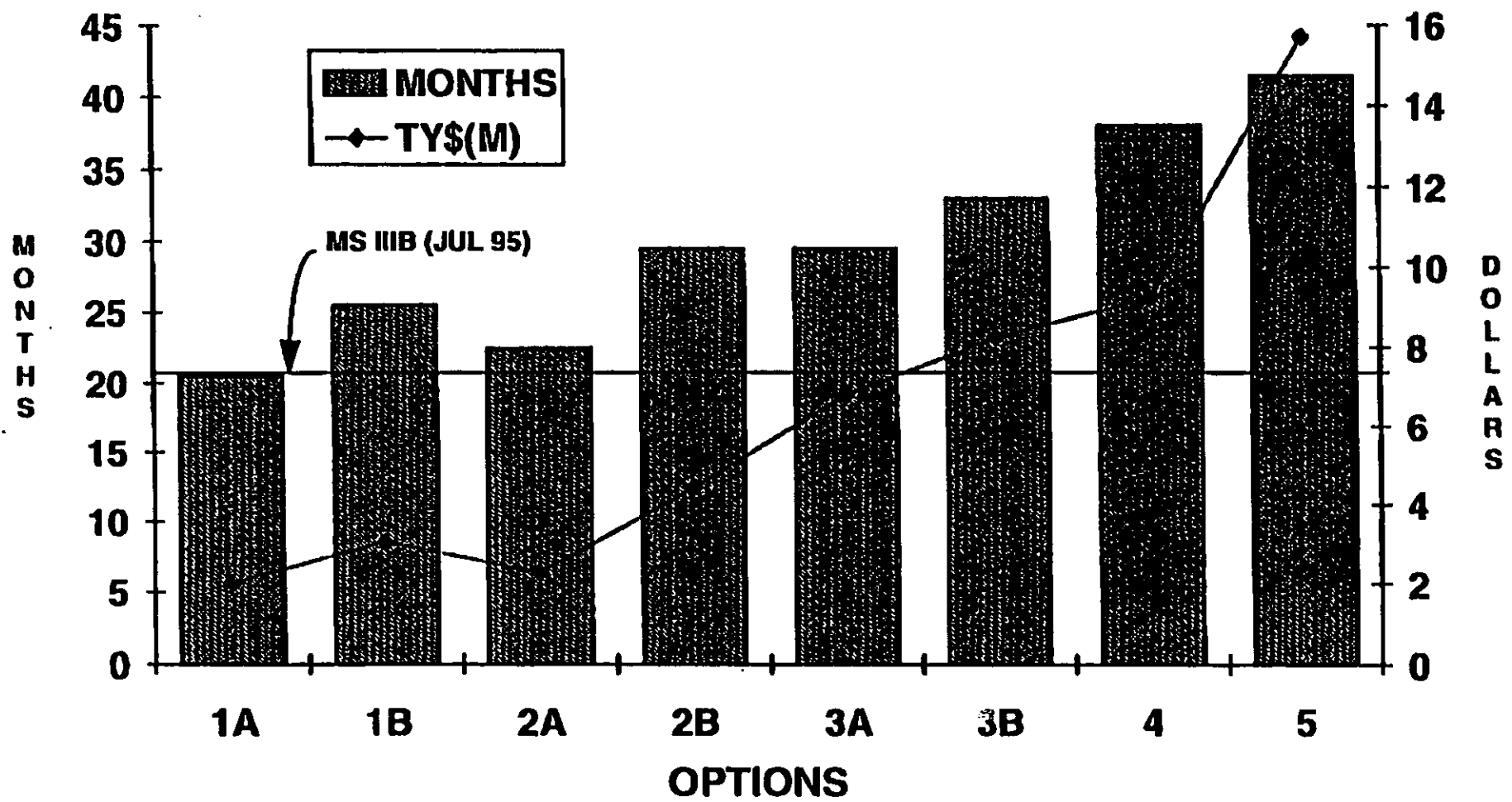

COST AND SCHEDULE ESTIMATES BASED ON PARTS BEING AVAILABLE WHEN ORDERED

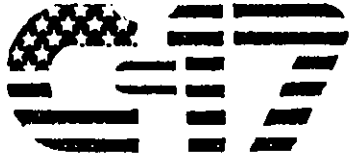

# OPTION COSTS STATIC WING ARTICLE LFT

OCT 20 '93 11:38AM

STATIC WING LFT COST DATA TY \$(M)	1A TANK #3 RAM	1B TANKS #3 & #4 RAM	2A TANK #3 WITH INTERNAL SYSTEMS	2B TANKS #3 & 4 WITH INTERNAL SYSTEMS	3A TANK #3 WITH INTERNAL SYSTEMS & TE	3B TWO TEST ARTICLES A) RAM B) TE SYSTEMS	4 TWO TEST ARTICLES A) RAM B) TE & LE SYSTEMS	5 RH WING WITH ALL SYSTEMS & 1 PYLON
DESIGN, FAB PLANNING	0.7	.97	0.76	1.13	1.75	2.26	2.56	4.51
TEARDOWN	0.09	0.05	0.09	0.05	0.09	0.10	0.10	0.10
TEST	0.64	1.12	0.64	1.12	0.72	1.20	1.20	2.43
COMPONENTS	0	0	0.14	.89	2.57	2.57	3.03	4.82
OGC	0.11	0.22	0.11	0.22	0.11	0.22	0.22	0.22
SUBTOTAL	1.54	2.36	1.74	3.41	5.24	6.35	7.11	12.08
SPD RES (30%)	.47	.69	.53	1.02	1.57	1.91	2.14	3.63
TOTAL	2.01	3.05	2.27	4.43	6.82	8.26	9.25	15.71
COMPLETION DATE								
NORM LDT ROB PROD	AUG 95 N/A	FEB 96 N/A	MAR 96 NOV 95	FEB 97 MAY 96	MAY 96 N/A	JUN 97 SEP 96	JAN 97 N/A	MAY 97 N/A

P.13

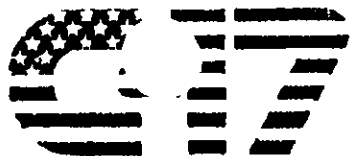

# **COST ESTIMATE MODEL CONSIDERATIONS**

- **DESIGN, FAB, PLANNING**
  - **DESIGN, FABRICATION AND PLANNING TO MAKE TEST ARTICLE REPRESENTATIVE**
    - » **ESTIMATED BY WRIGHT LABS**
- **TEARDOWN AND TRANSPORTATION**
  - **8 PERSON TEAM FROM SAN ANTONIO ALC/LAA**
    - » **DISASSEMBLY, CRATE AND TRANSPORT**
- **TEST**
  - **INSPECTION, SEALING, SET-UP, TESTING, TEARDOWN AND REPORTING**
    - » **ESTIMATED BY WRIGHT LABS**
- **COMPONENTS**
  - **PARTS NOT MANUFACTURED AT WRIGHT LABS**
  - **SUPPLIER DATA FOR CURRENT QUOTES**
  - **SPARES FOR TEST CONSUMABLES**
    - » **PARTS AND SPARE REQUIREMENTS ESTIMATED BY YCE**
  - **PARTS ASSUMED AVAILABLE**



## **PRODUCTION PARTS LEAD TIME**

- **64 PARTS IDENTIFIED AS HAVING LEAD TIMES > 6 MONTHS**
  - **FUEL & HYDRAULIC SYSTEMS; STRUCTURES**
- **LONGEST LEAD: 32 MONTHS (PYLON)**
- **MEAN LEAD TIME: 13 MONTHS**
- **WIRE HARNESSSES NOT YET ANALYZED FOR LEAD TIMES**

**IF PARTS ARE TAKEN FROM PRODUCTION LINE, UNQUANTIFIED DELAY & DISRUPTION COSTS WILL BE INCURRED**

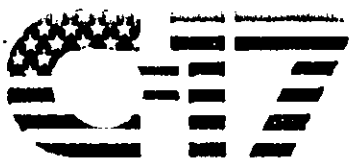

# LIVE FLIGHT TEST ISSUES

1. **RIGHT HAND WING USEABLE/SUITABLE** *What happens if wing broken*
2. **PARTS AVAILABILITY**
  - **PRODUCTION IMPACT**
3. **DEFINITION OF PRODUCTION REPRESENTATIVE**
4. **12.7 MM HEI AVAILABILITY**

OCT 20 '93 11:40AM



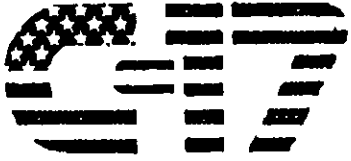

# **SPO LIVE FIRE TEST RECOMMENDATION**

- PROCEED WITH OPTION 1A**
  - PERFORM HYDRODYNAMIC RAM TESTING ON #3 INBOARD TANK**
- JUSTIFICATION**
  - LOWEST TECHNICAL RISK**
  - SCHEDULE ESTIMATE MEETS MS IIIB**
  - LOWEST COST**
  - NO PARTS/PRODUCTION IMPACT**
  - MEETS INTENT OF LFT LAW**
  - FULFILLS OUTSTANDING DATA REQUIREMENTS**

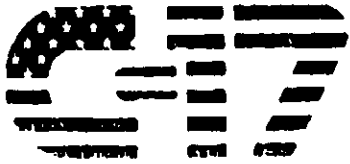

# STATIC TEST ARTICLE REPAIR L/H WING MODIFICATION

OCT 20 '93 11:41AM

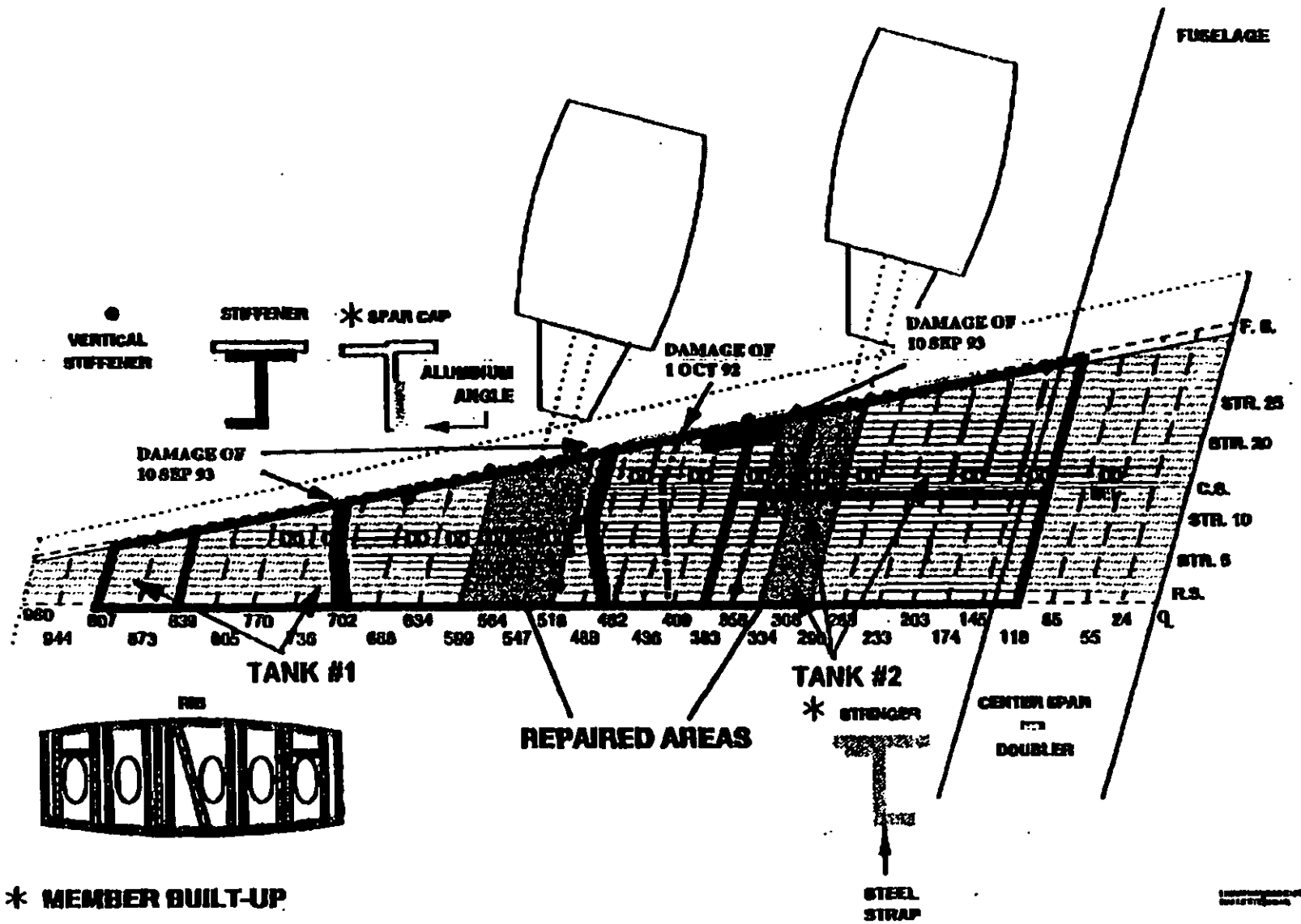

\* MEMBER BUILT-UP

P.18

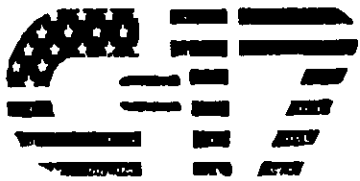

# STATIC TEST ARTICLE RETROFIT & INITIAL PRODUCTION R/H WING MODIFICATION

OCT 20 '93 11:41AM

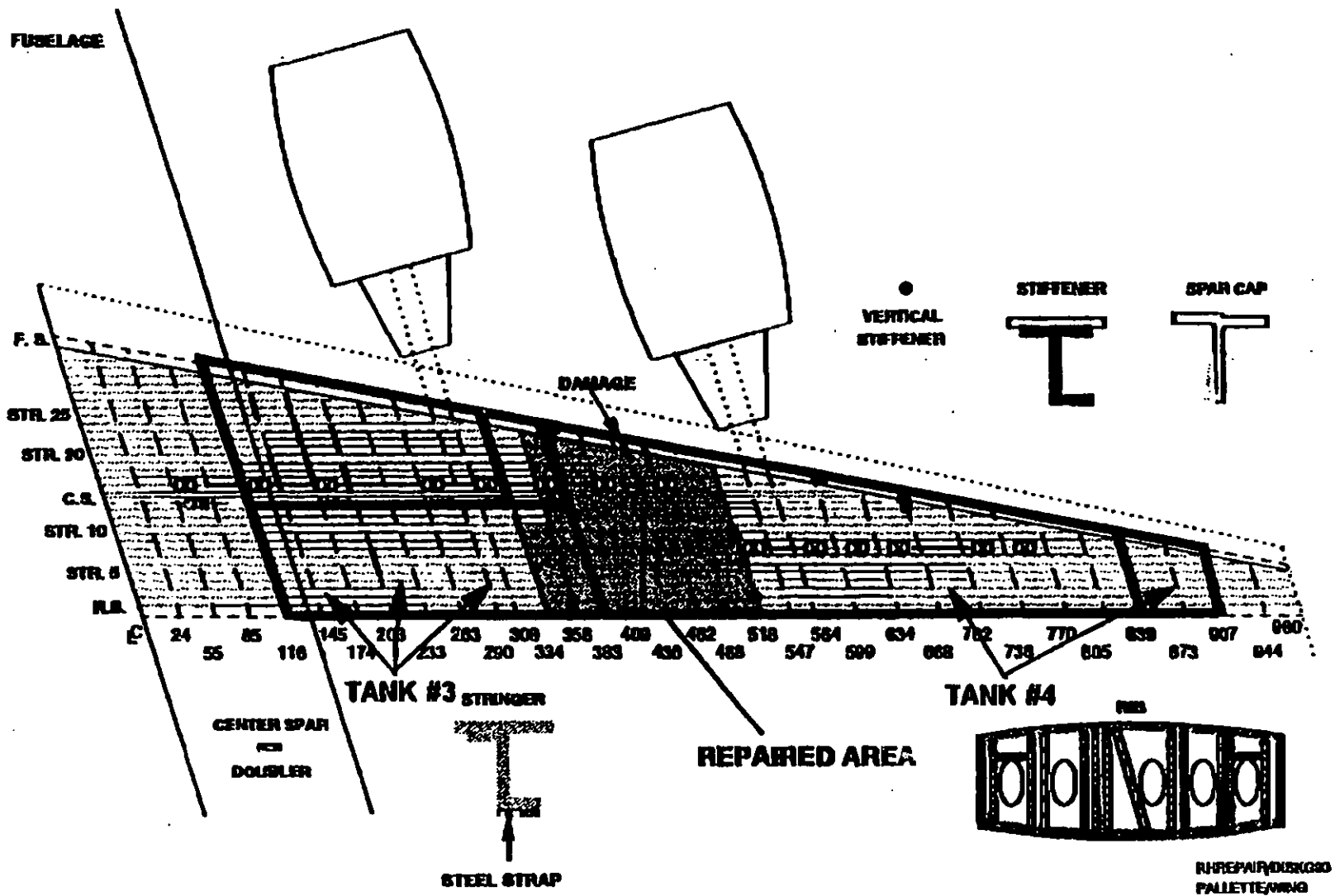

P.19

# LFT Option 1e "A"

## Structural Hydrodynamic Ram Test of Inboard Main Fuel Tank

OCT 20 '93 01:18PM

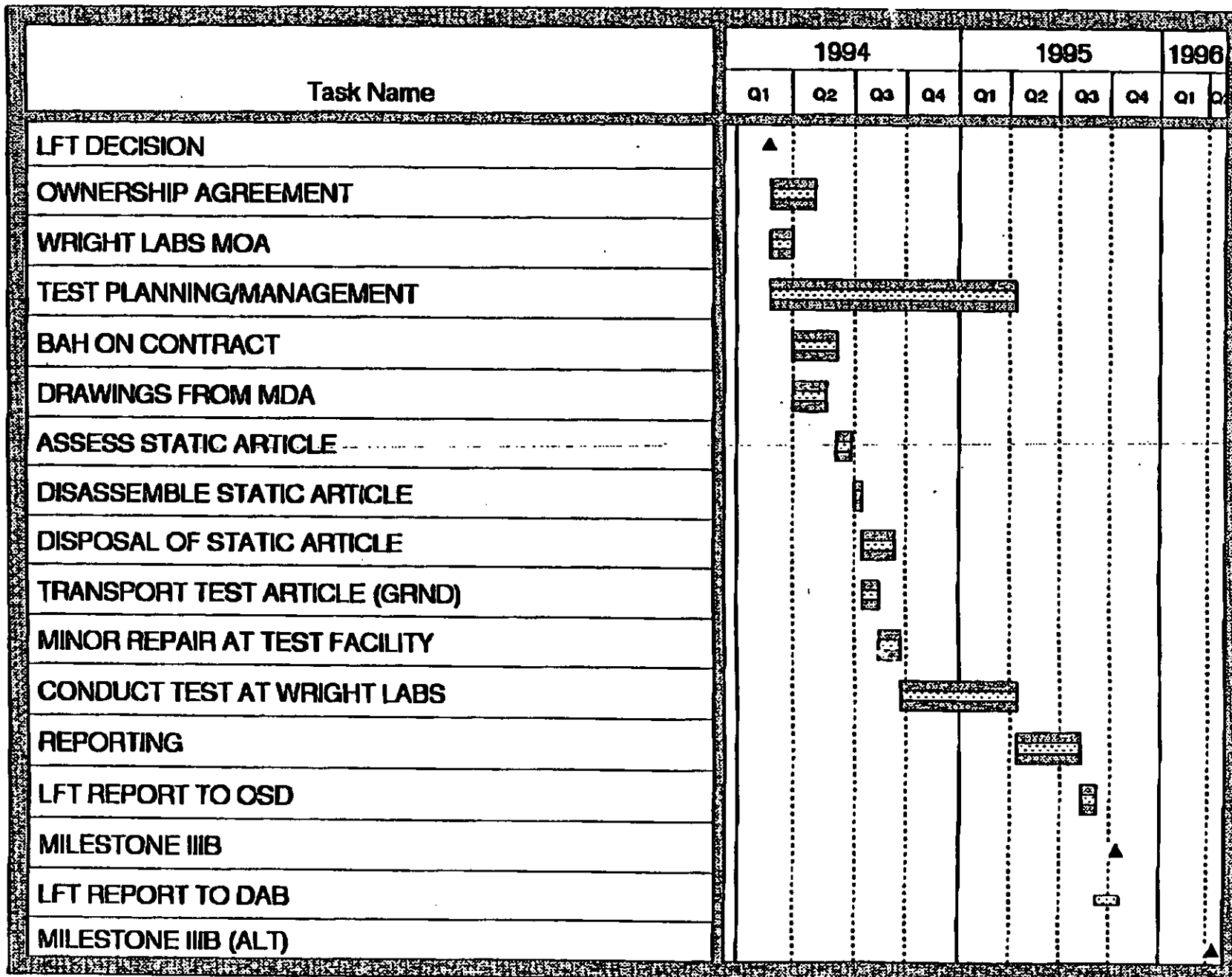

P.3

# LFT Op 1 One "B"

## Structural Hydrodynamic Ram Test of Semi-Span Inboard and Outboard Fuel Tanks

OCT 20 '93 01:19PM

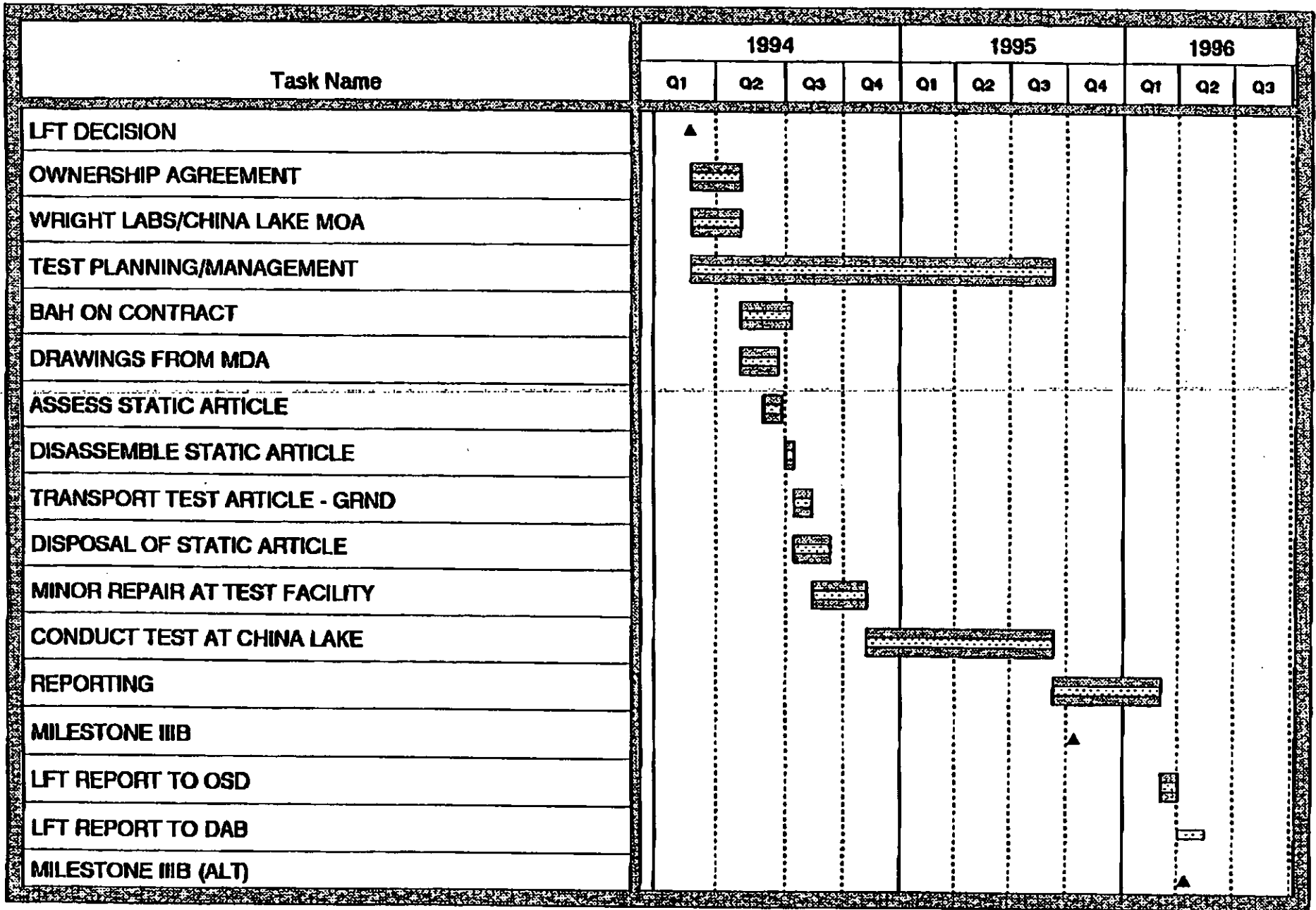

P. 4

# LFT Op 1 Two "A"

## Structural and Internal Systems Hydrodynamic Ram Test

### Inboard Main Fuel Tank (Parts from Production Available)

OCT 20 '93 01:19PM

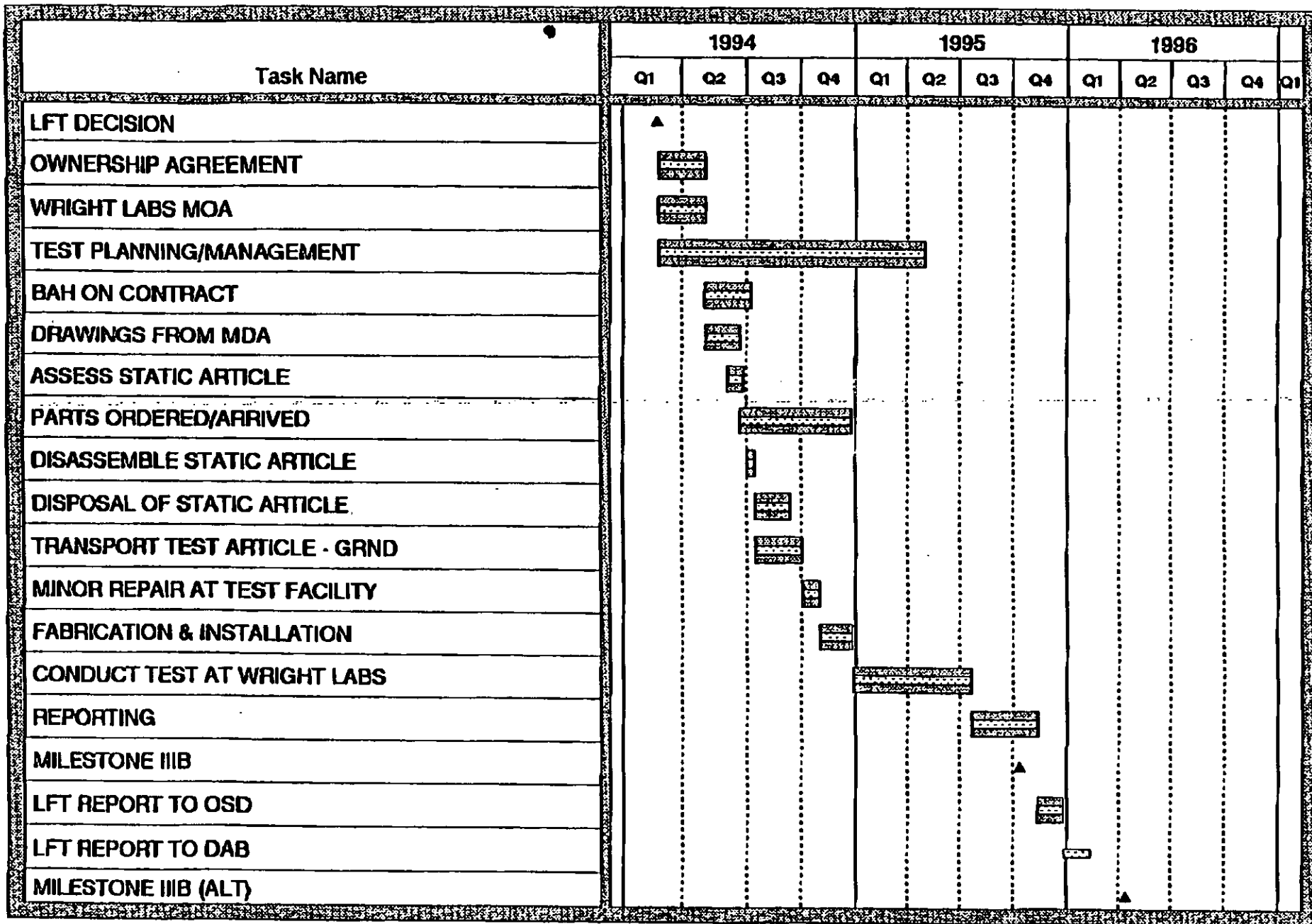

P.5

# LFT Op Two "A"

## Structural and Internal Systems Hydrodynamic Ram Test Inboard main Fuel Tank (Normal Lead Time)

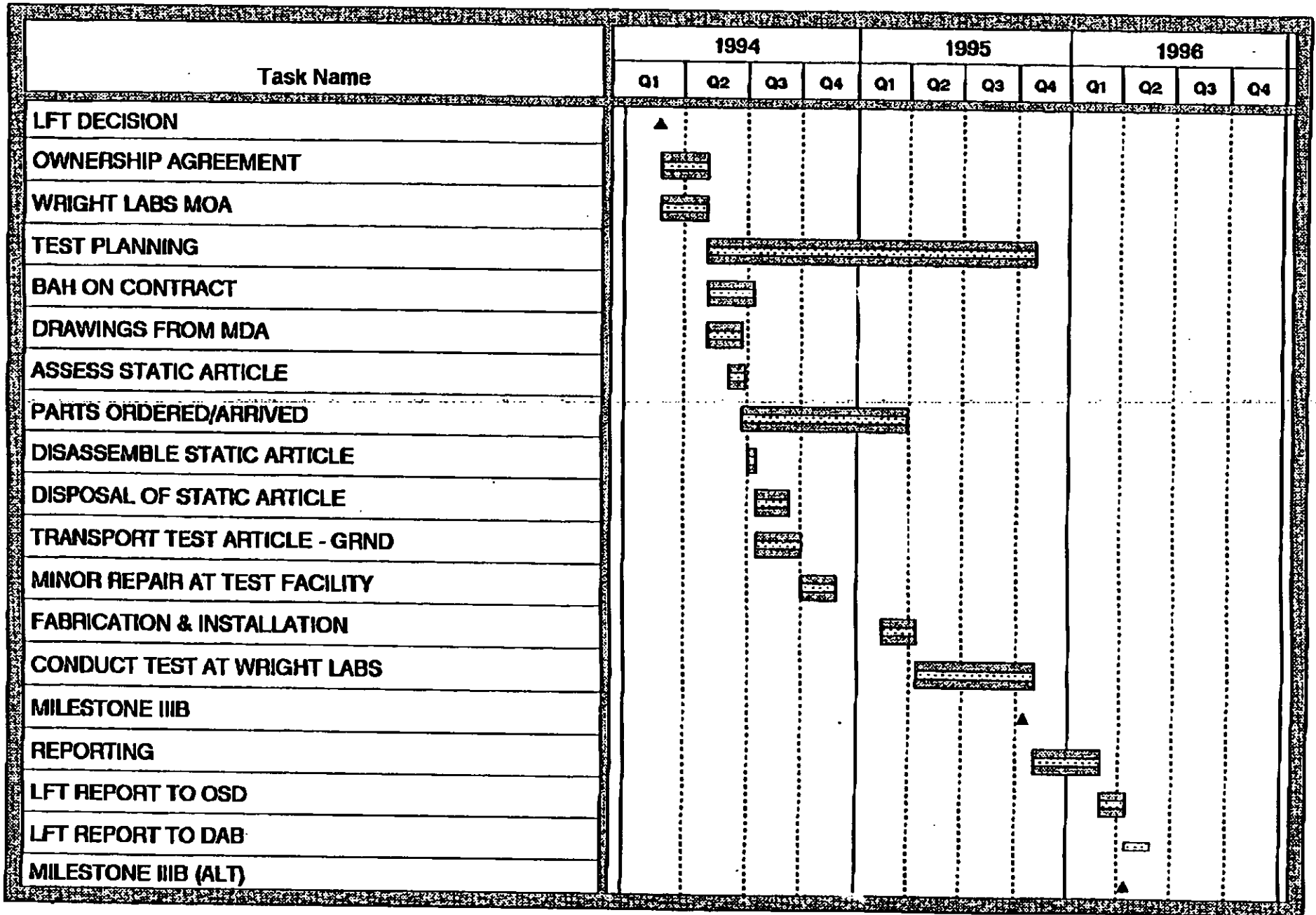

# LFT Option "B"

## Structural and Internal Systems Hydrodynamic Ram Test of Semi-Span Inboard and Outboard Fuel Tanks (Parts from Production Available)

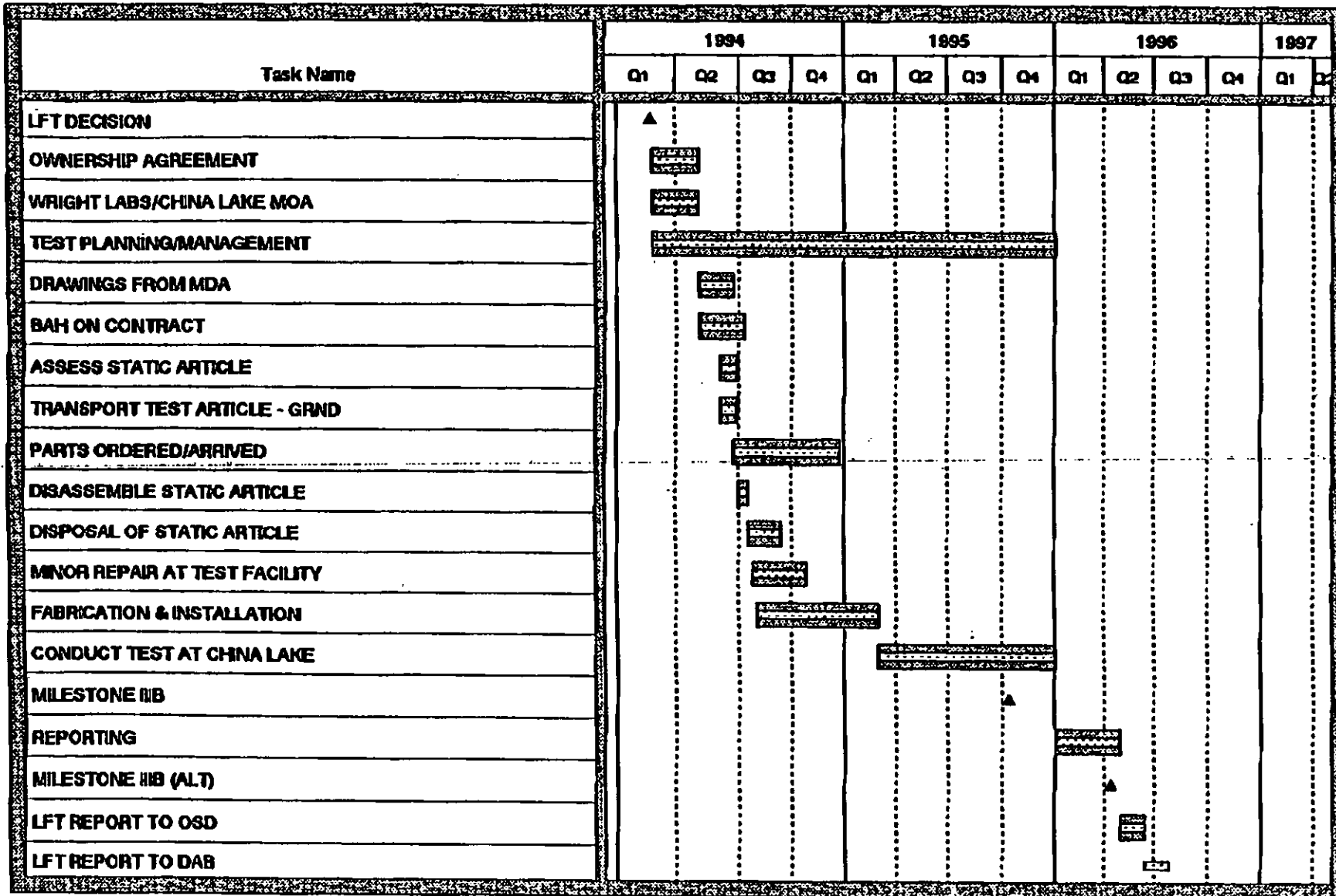

OCT 20 '93 01:20PM

P.7



# LFT Option "B"

## Structural and Internal Systems Hydrodynamic Ram Test of Semi-Span Inboard and Outboard Fuel Tanks (Normal Lead Time)

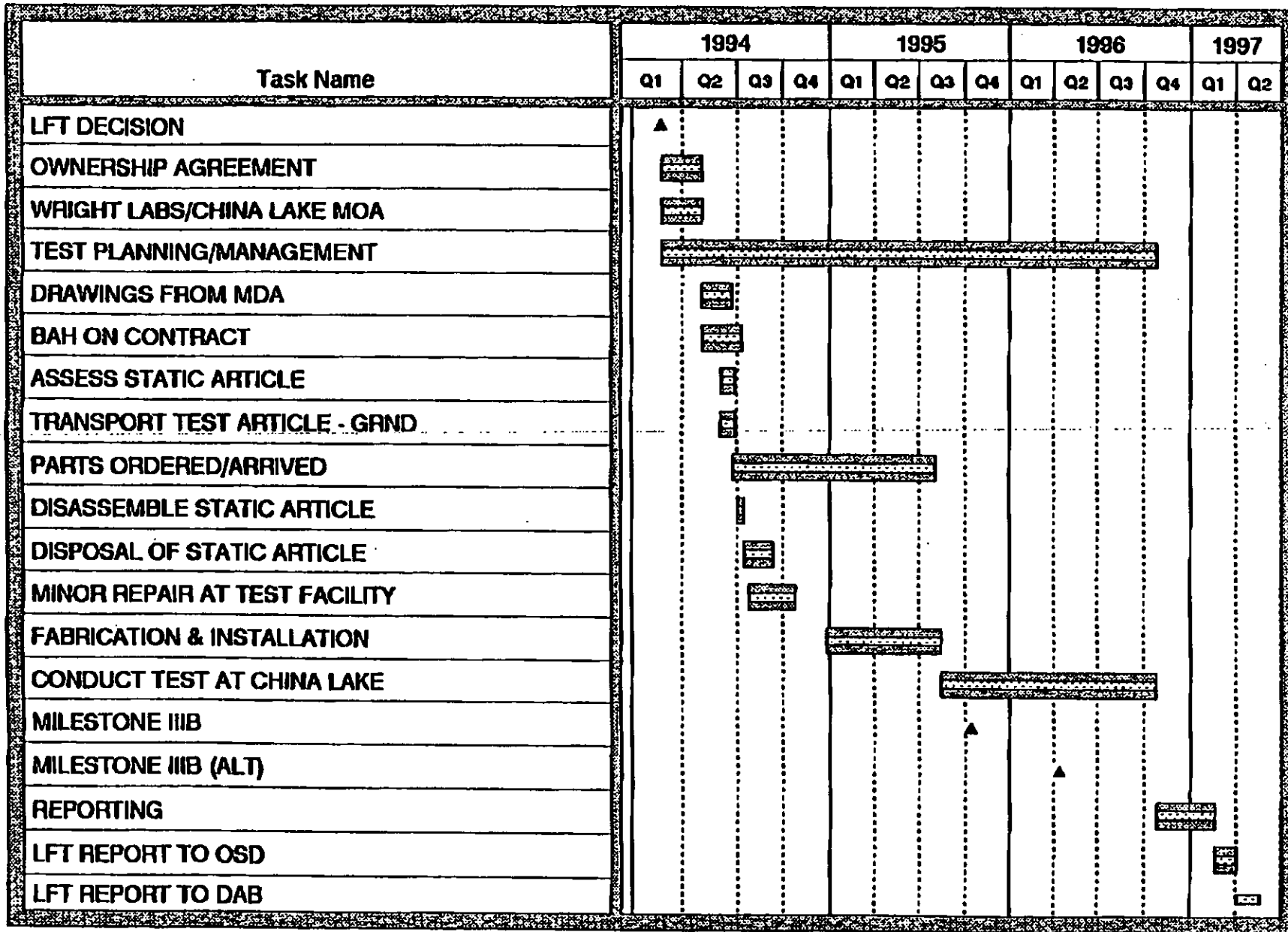

# Option Tree "A"

## Structural, Internal Systems Hydrodynamic Ram & Trailing Edge Dry Bay Test Inboard Fuel Tank

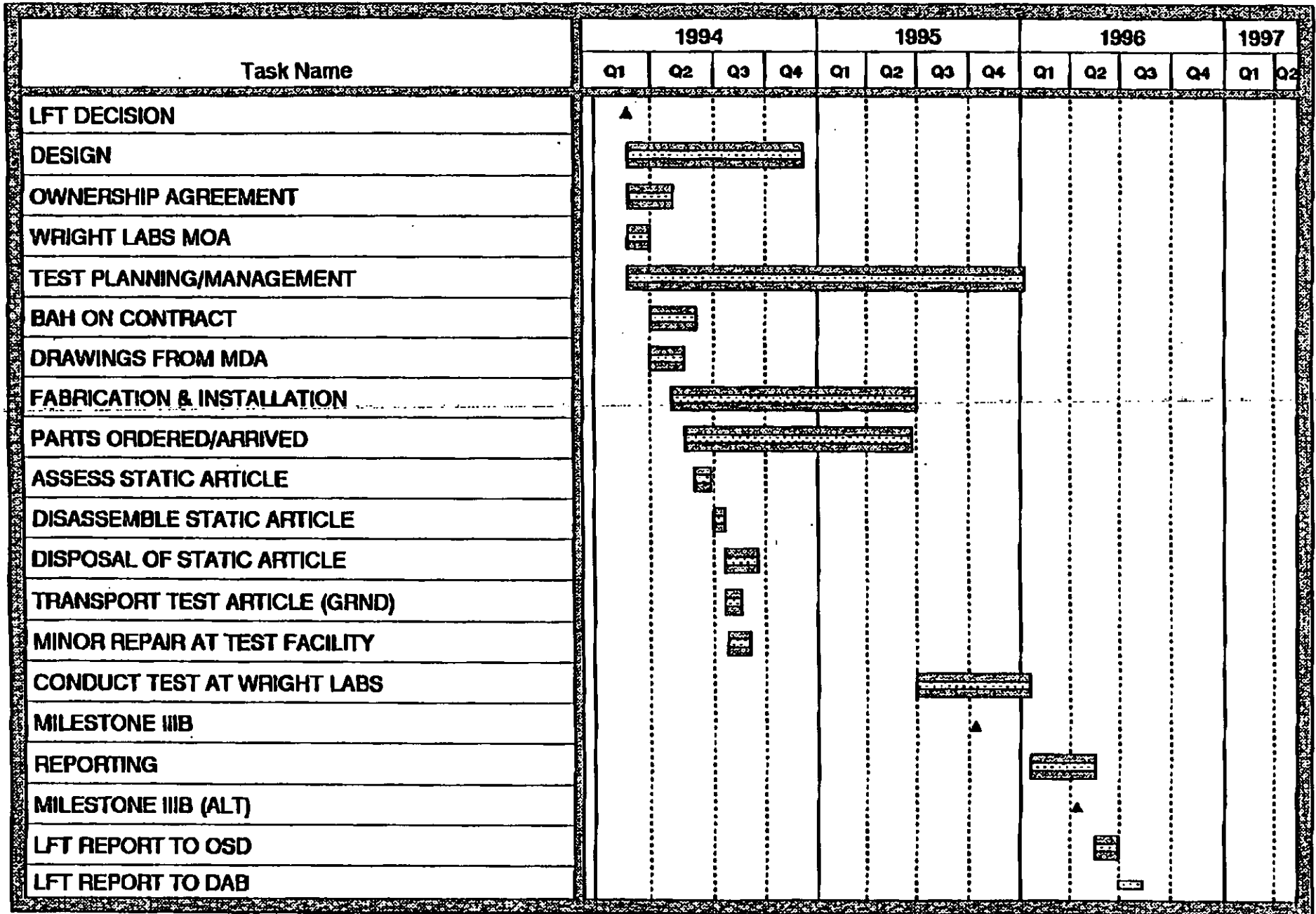

OCT 20 '93 01:22PM

P. 9

# LFT Opti Three "B"

Structural, Internal Systems Hydrodynamic Ram & Trailing Edge Dry Bay Test  
Both Inboard Fuel Tanks(Parts from Production Available)

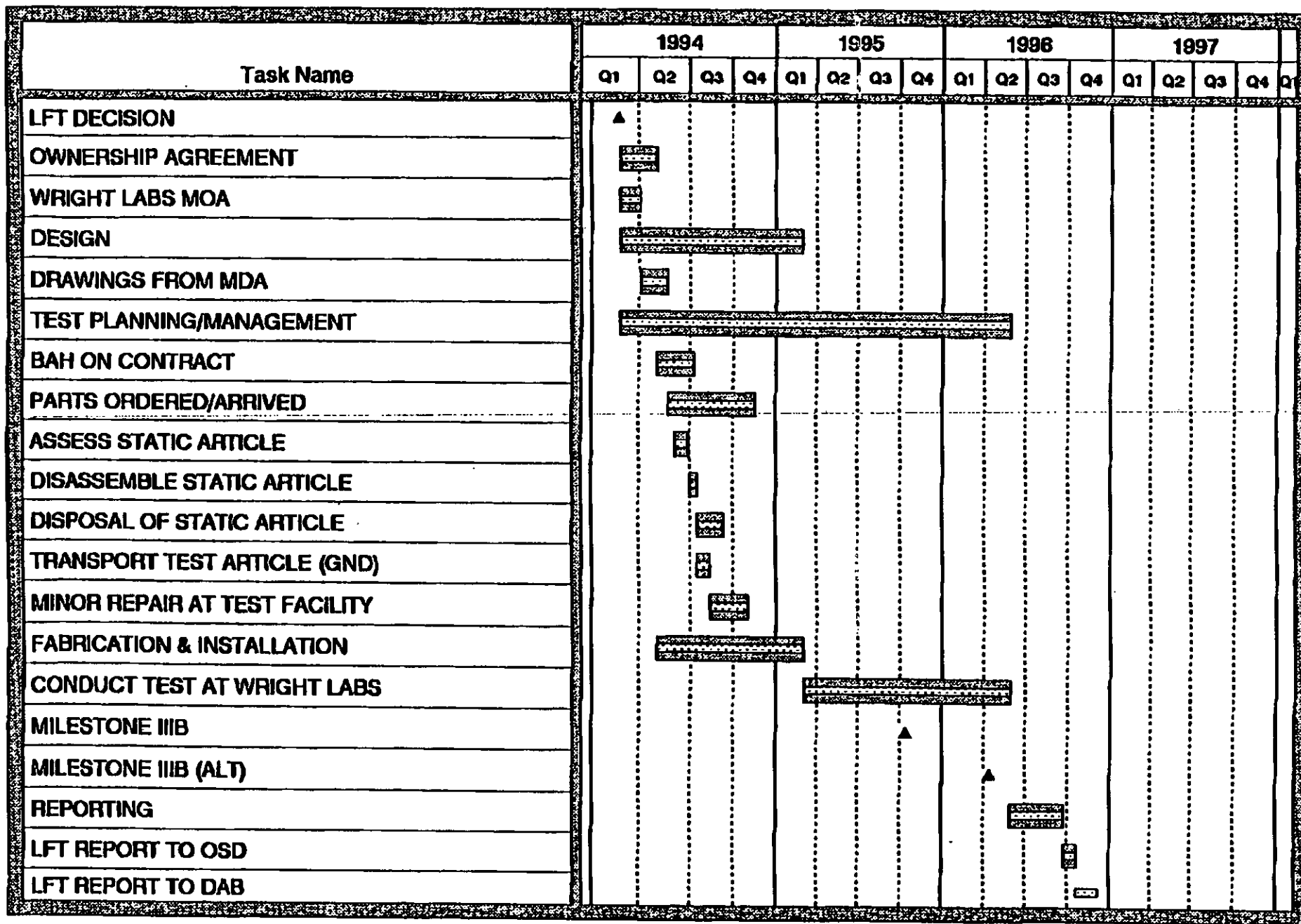

OCT 20 '93 01:22PM

P.10

# LFT Op<sup>r</sup> Three "B"

## Structural, Internal Systems Hydrodynamic Ram & Trailing Edge Dry Bay Test Both Inboard Fuel Tanks(Normal Lead Time)

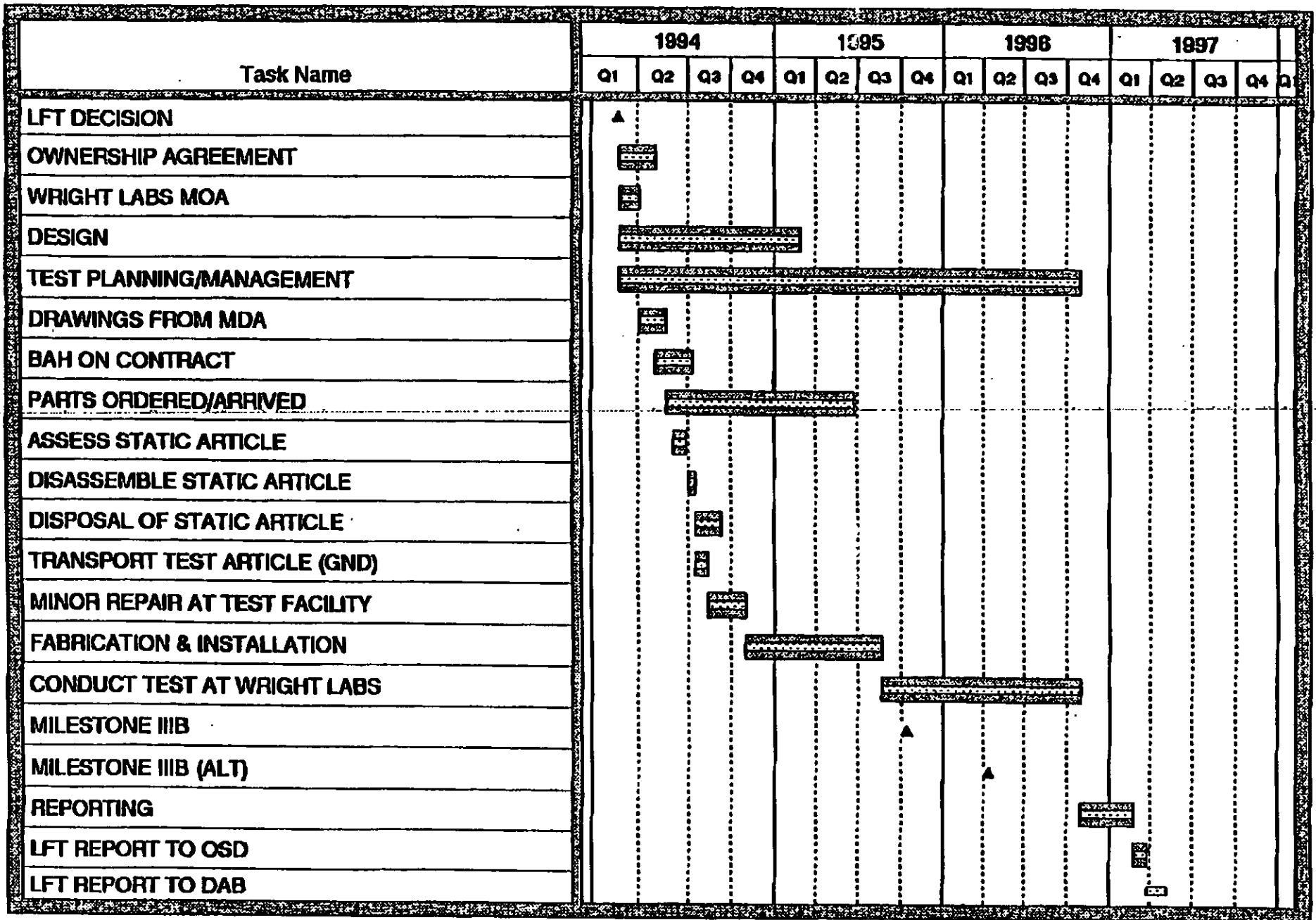

**LFT Optic Four**  
**Structural, Internal Systems & Dynamic Ram Testing**  
**Leading Edge & Trailing Edge Dry Bay Testing -- Both Inboard Fuel Tanks**

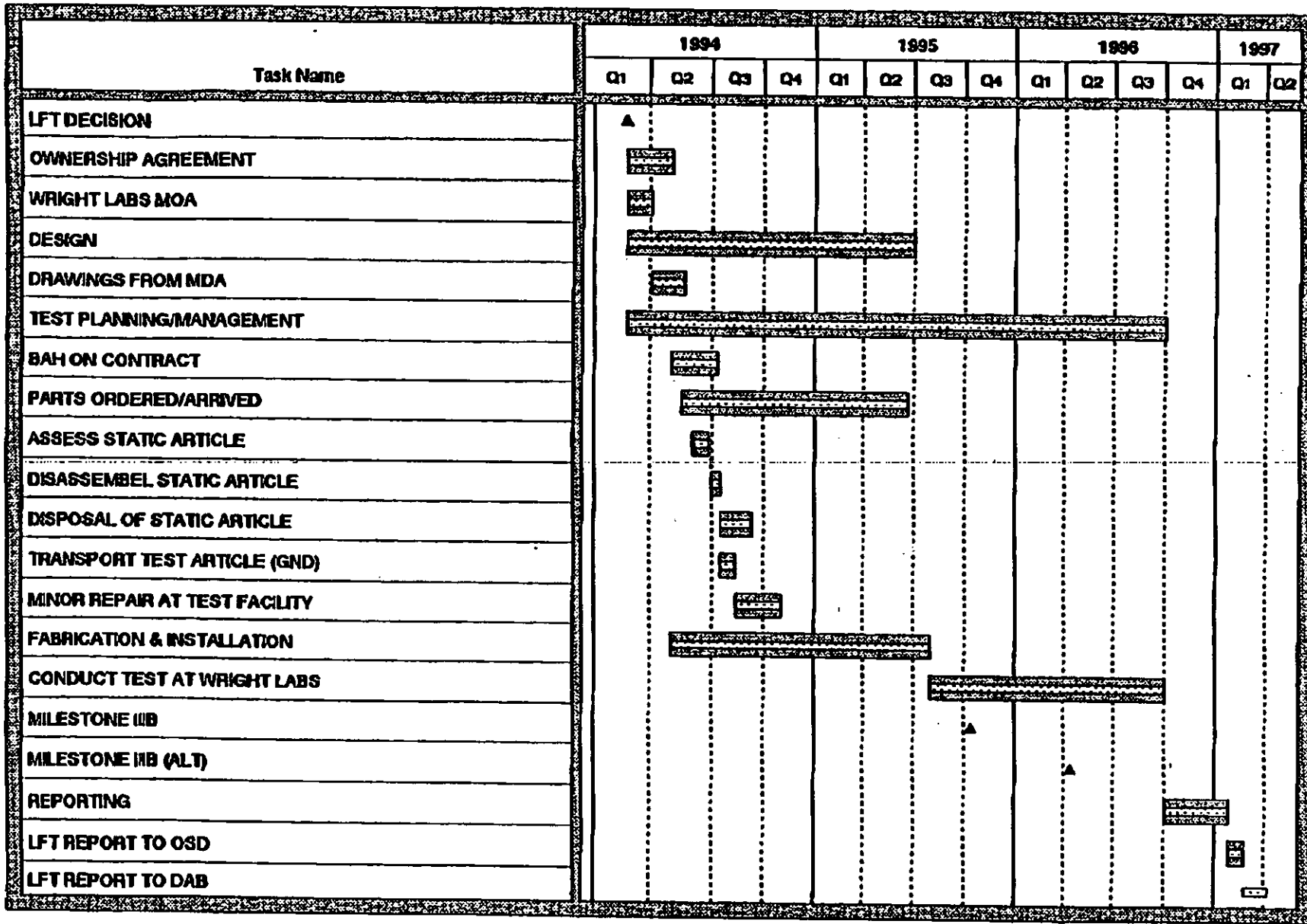

OCT 20 '93 01:24PM

P.12

B12

# LFT Opti Five

## RH Wing From Static Article Rebuilt With All Systems Hydrodynamic Ram, Leading & Trailing Edge Systems, and Pylon

OCT 20 '93 01:24PM

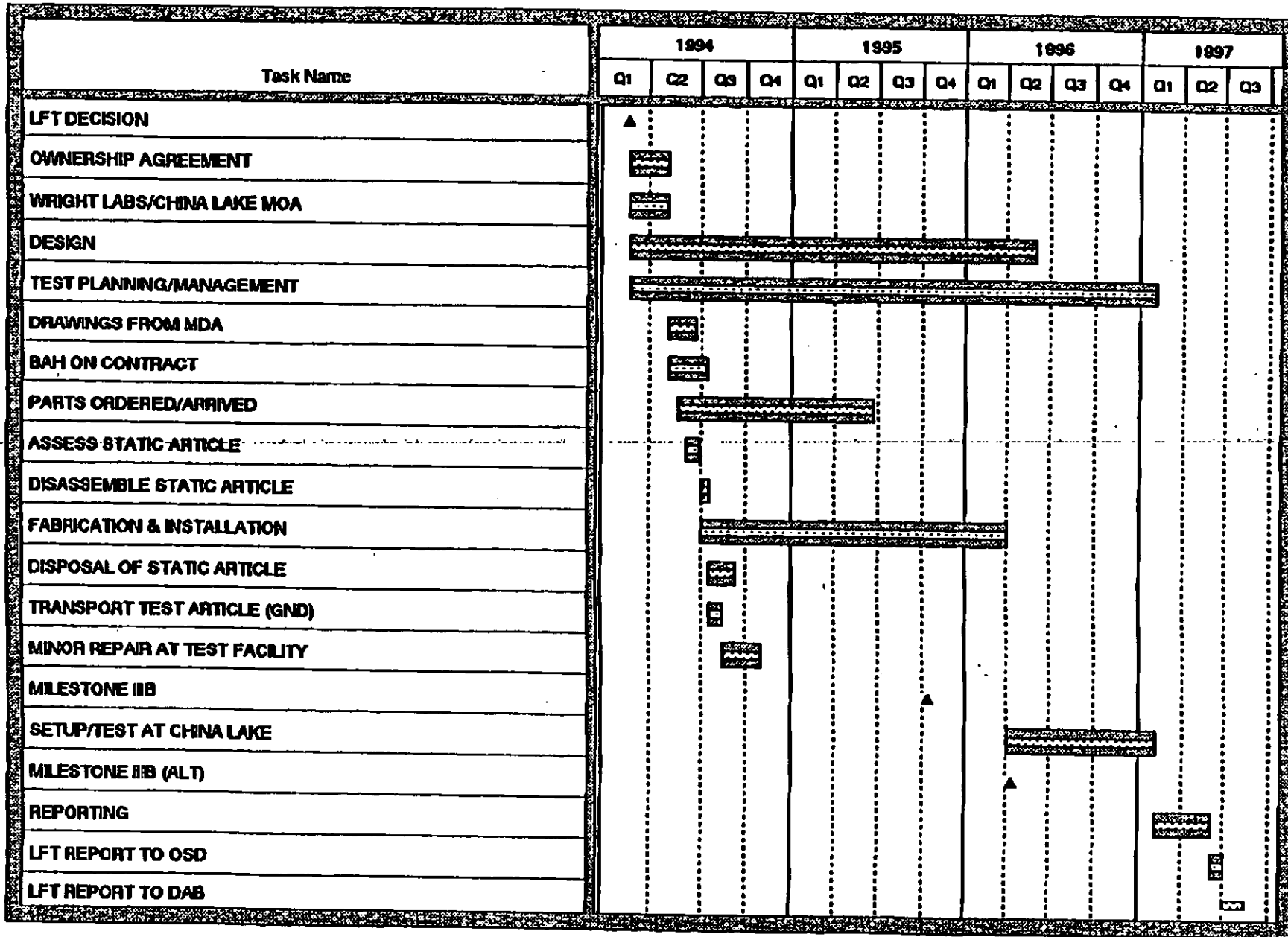

P.13



DEPARTMENT OF THE AIR FORCE  
WASHINGTON DC 20330-1000

OFFICE OF THE ASSISTANT SECRETARY

DEC 03 1992

SAF/AQ  
Pentagon RM 4E964  
Washington DC 20330-1000

MEMORANDUM FOR PRINCIPAL DEPUTY UNDER SECRETARY OF DEFENSE  
ACQUISITION

SUBJECT: C-17 Vulnerability Program

I am writing to provide the Air Force approach for assessing the vulnerability of the C-17 aircraft for your review and consideration. The design of the aircraft should have the highest practical level of protection against threats that cannot readily be detected, evaded, or countered, consistent with the planned operation of the C-17. In addition, test planning will take into account potential cost, schedule and performance implications. In this regard, testing will be limited to assessment of single shot vulnerabilities for which there are potential practical fixes of modest cost and minimal weight penalties.

The FY93 Authorization Act requires that, "... sufficiently large and realistic components and subsystems ..." be used in any C-17 Live Fire Test (LFT) program alternative. To date, we have been unable to reach agreement with the OSD staff on an acceptable plan. As a result, we have modified our phased LFT approach (outlined in the Aug 92 C-17 Test and Evaluation Master Plan) as described below to address the OSD concerns.

Testing will be accomplished on a production representative wing (probably the static test article wing with the leading and trailing edge dry bays reconfigured to include fuel, hydraulic, electrical and other systems). The tests will determine the vulnerability of the aircraft to 1) ram-induced structural failure and 2) dry bay fire initiation and sustainment in the wings. The test program will be conducted in two phases. The first will determine if potential vulnerabilities identified through analysis actually exist, and the second will test any proposed modifications to resolve the vulnerabilities, if the condition of the test article makes such testing practical. The wing will be subjected to 12.7mm API and HEI and then 14.5mm API and HEI projectile ballistic tests until the test article is rendered unsuitable for additional testing.

Since the scope of this testing is beyond what was previously planned for the C-17, we will provide a detailed implementation plan within 90 days of your concurrence on this approach which will include budget, required funding, schedule, and test range requirements.

A handwritten signature in black ink, appearing to read "G. Kim Wincup".

G. KIM WINCUP  
Assistant Secretary of the Air Force  
(Acquisition)

Notation System for Changes

~~additions~~

~~deletions~~

[rationale for change]

SAF/AQ

Pentagon RM 4E964

Washington DC 20330-1000

MEMORANDUM FOR PRINCIPAL DEPUTY UNDER SECRETARY OF DEFENSE  
ACQUISITION

SUBJECT: C-17 Vulnerability Program

I am writing to provide the Air Force approach for assessing the vulnerability of the C-17 aircraft for your review and consideration. The design of the aircraft should have the highest practical level of protection against threats that cannot readily be detected, evaded, or countered, consistent with the planned operation of the C-17. In addition, test planning will take into account potential cost, schedule and performance implications. In this regard, testing will be limited to assessment of single shot vulnerabilities for which there are potential practical fixes of modest cost and minimal weight ~~and fuel capacity~~ penalties [some of the fixes looked at may reduce fuel capacity, which will aggravate payload/range].

The FY93 Authorization Act requires that, "...sufficiently large and realistic components and subsystems..." be used in any C-17 Live Fire test (LFT) program alternative. To date, we have been unable to reach agreement with the OSD staff on an acceptable plan. As a result, we have modified our phased LFT approach (outlined in the Aug 92 C-17 Test and Evaluation Master Plan) as described below to address the OSD concerns.

Testing will be accomplished on a ~~C-17~~ production representative wing [to insure tests are done on a C-17 type wing precluding substitution of some other aircraft's wing] (probably the static test article wing with the leading and trailing edge dry bays reconfigured to include fuel, hydraulic, electrical and other systems). The tests will determine the vulnerability of the aircraft to 1) ram-induced structural failure and 2) dry bay fire initiation and sustainment in the wings. The test program will be conducted in two phases. The first will determine if potential vulnerabilities identified through analysis actually exist, and the second will test any proposed modifications to resolve the vulnerabilities, ~~if the condition of the test article makes such testing practical~~ [to restore test of fixes on some C-17 wing even if one of the two static half-wings cannot be used for testing fixes]. The wing will ~~first~~ be subjected to 12.7mm API ~~to verify contractual compliance~~ [to first determine if C-17



complies with contractual spec and then the other threats] and then to 12.7mm and HEI and 14.5mm API and HEI projectile ballistic tests until the test article is rendered unsuitable for additional testing. Upon completion of these tests, the Air Force, in consultation with your staff, will consider extending the tests to 20 and 23mm projectiles [to restore possibility of conducting higher caliber tests, including corresponding ram effects]

In addition to these tests, additional analyses will be performed to determine, when the aircraft is subjected to the 12.7 and 14.5mm projectiles above, vulnerability with respect to pylon fire, vulnerability with respect to potential user casualties, and whether catastrophic vulnerabilities exist (e.g., major structural damage due to detonation of selected flammables and explosives cargoes, disabling of the aircrew or the throttle quadrant) [although substantial analysis has been done, it did not include all of the projectiles types called for, or the impact of ammunition or fuel detonations affecting the aircraft structure, nor fully reflect requirements of the October 23, 1992, FY 93 Authorization Act, P. L. 102-484 regarding user casualties]

Since the scope of this testing is beyond what was previously planned for the C-17, we will provide an outline of the implementation plan and draft waiver language required by P. L. 102-484, section 132. (c) within 30 days and [to provide early information on Air Force planning and waiver per P. L. 102-484] a detailed implementation plan within 90 days of your concurrence on this approach which will include budget, required funding, schedule, and test range requirements.

Prepared by Dr. Milton J. Minneman, S&SS(AS), x53359, December 17, 1992

File: c17vair.b\* pg 14

SAF/AQ  
Pentagon RM 4E964  
Washington DC 20330-1000

MEMORANDUM FOR PRINCIPAL DEPUTY UNDER SECRETARY OF DEFENSE  
ACQUISITION

SUBJECT: C-17 Vulnerability Program

I am writing to provide the Air Force approach for assessing the vulnerability of the C-17 aircraft for your review and consideration. The design of the aircraft should have the highest practical level of protection against threats that cannot readily be detected, evaded, or countered, consistent with the planned operation of the C-17. In addition, test planning will take into account potential cost, schedule and performance implications. In this regard, testing will be limited to assessment of single shot vulnerabilities for which there are potential practical fixes of modest cost and minimal weight and fuel capacity penalties.

The FY93 Authorization Act requires that, "...sufficiently large and realistic components and subsystems..." be used in any C-17 Live Fire test (LFT) program alternative. To date, we have been unable to reach agreement with the OSD staff on an acceptable plan. As a result, we have modified our phased LFT approach (outlined in the Aug 92 C-17 Test and Evaluation Master Plan) as described below to address the OSD concerns.

Testing will be accomplished on a C-17 production representative wing (probably the static test article wing with the leading and trailing edge dry bays reconfigured to include fuel, hydraulic, electrical and other systems). The tests will determine the vulnerability of the aircraft to 1) ram-induced structural failure and 2) dry bay fire initiation and sustainment in the wings. The test program will be conducted in two phases. The first will determine if potential vulnerabilities identified through analysis actually exist, and the second will test any proposed modifications to resolve the vulnerabilities. The wing will first be subjected to 12.7mm API to verify contractual compliance and then to 12.7mm HEI and 14.5mm API and HEI projectile ballistic tests until the test article is rendered unsuitable for additional testing. Upon completion of these tests, the Air Force, in consultation with your staff, will consider extending the tests to 20 and 23mm projectiles.

In addition to these tests, additional analyses will be performed to determine, when the aircraft is subjected to the 12.7 and 14.5mm projectiles above, vulnerability with respect to pylon fire, vulnerability with respect to potential user casualties, and whether catastrophic vulnerabilities exist (e.g.,

major structural damage due to detonation of selected flammables and explosives cargoes, disabling of the aircrew or the throttle quadrant).

Since the scope of this testing is beyond what was previously planned for the C-17, we will provide an outline of the implementation plan and draft waiver language required by P. L. 102-484, section 132. (c) within 30 days and a detailed implementation plan within 90 days of your concurrence on this approach which will include budget, required funding, schedule, and test range requirements.

Prepared by Dr. Milton J. Minneman, S&SS(AS), x53359, December 17, 1992

File: c17vulnr.bit pg 20

**C-17 LIVE FIRE TEST AND  
EVALUATION DETAILED TEST PLAN  
HYDRODYNAMIC RAM TEST**

**9 NOVEMBER 1992**

**PREPARED BY:**

**APPROVED BY:**

  
KURT R. LEE, 1st Lt, USAF  
Test Engineer  
Survivability Enhancement Branch

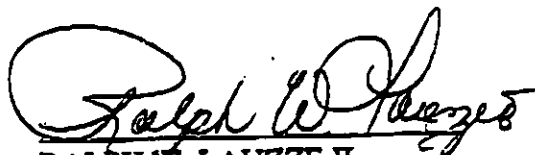
  
RALPH W. LAUZZE II  
WL LFT Director  
Vehicle Subsystems Division

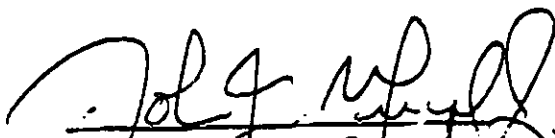
  
JOHN J. MURPHY, Jr.  
WL C-17 LFT Program Manager  
Survivability Enhancement Branch

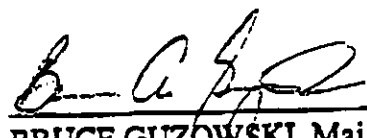
  
BRUCE GUZOWSKI, Maj, USAF  
Live Fire Test Manager  
C-17 SPO

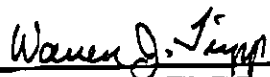
  
WARREN J TRIPP  
Systems Integration Engineer  
C-17 SPO

## TABLE OF CONTENTS

1.	INTRODUCTION .....	1
2.	TEST AND EVALUATION ISSUE .....	2
	2.1 Issue .....	2
	2.2 Measure of Evaluation .....	2
3.	TEST AND EVALUATION APPROACH .....	3
	3.1 Analytical Method .....	3
	3.2 Empirical Method .....	4
	3.3 Test Objective .....	5
	3.3.1 Phase I Test Objective .....	5
	3.3.2 Phase II Test Objective .....	5
	3.4 Data Requirements .....	5
	3.4.1 Data Requirements Associated with Phase I MOE .....	5
	3.4.2 Phase I Instrumentation .....	6
	3.4.3 Phase I Optical and Audio Records .....	12
	3.4.4 Data Requirements Associated with Phase II MOE .....	12
	3.4.5 Phase II Instrumentation .....	12
	3.4.6 Phase II Optical and Audio Records .....	12
	3.4.7 Damage Assessment Records .....	12
	3.5 Test Setup .....	13
	3.5.1 Threat Characteristics and Specifications .....	13
	3.5.2 Phase I Target Characteristics .....	13
	3.5.3 Phase I Test Conditions and Matrix .....	14
	3.5.4 Phase II Target Characteristics .....	14
	3.5.5 Phase II Test Conditions and Matrix .....	14
	3.6 Analytical/Evaluation Assessment Procedures .....	14
4.	DOCUMENTATION .....	15
5.	REFERENCES .....	16

**LIST OF FIGURES**

Figure 3.1 Pressure Probes Through Upper Wing Skin. . . . . 7

Figure 3.2 Pressure Probes Through Front Spar. . . . . 8

Figure 3.3 Upper and Lower Wing Skin Strain Gage Locations. . . . . 9

Figure 3.4 Internal Frame Strain Gage Locations. . . . . 10

Figure 3.5 Bulkhead Strain Gage Locations. . . . . 10

Figure 3.6 Spar Strain Gage Locations. . . . . 11

Figure 3.7 Test Article Mounting. . . . . 13

**LIST OF TABLES**

Table 3.1 Phase I Shot Matrix. . . . . 14

## 1. INTRODUCTION

Chapter 139 of Title 10, United States Code, Section 2366, states, "a covered system may not proceed beyond low-rate initial production until realistic survivability testing is completed . . ." As requested by the C-17 System Program Office (SPO), HQ AFSC designated the Vehicle Subsystems Division, Flight Dynamics Directorate, Wright Laboratory (WL/FIV) the Responsible Test Organization for the C-17 Live Fire Test (LFT) program. The C-17 LFT program will be conducted at the Aircraft Survivability Research Facility, Wright Patterson AFB, OH and other government test ranges as necessary.

This test plan details supplemental testing to the C-17 LFT program to address a concern that catastrophic structural damage may be inflicted on the structure of a wing from the pressure and fragmentation effects of the 23mm High Explosive Incendiary - Tracer (HEI-T) antiaircraft projectile. While there is a large data base on the performance of the 23mm HEI-T, only limited information is available on the damage that can be inflicted by the fragmentation and blast of a 23mm HEI-T round on a large wing tank.

The pressure effects of an HEI-T projectile in a fluid filled container are often generically referred to as "hydrodynamic ram". Two types of pressure effects are typically observed with the detonation of a high explosive projectile, however, and the contribution of each effect to the global damage of the wing tank is important. The extremely rapid pressure build up associated with the detonation of the projectile generates a blast (pressure) wave in the fluid. This wave initially propagates at a velocity greater than the speed of sound in the fluid (supersonic) and is characterized by a nearly instantaneous pressure rise to a peak pressure, followed by an exponential decay of pressure as the wave passes. This blast wave can have peak overpressures well in excess of 1000 psi several feet from the detonation point (for a 23mm HEI-T projectile), but the duration of the pressure pulse is measured in milliseconds. The effect of the blast wave on tank wall structure is not affected by the amount of venting or ullage in the tank, since the blast wave is not influenced by fluid conditions behind the shock.

After the detonation, a bubble of expanding combustion products begins to exert another pressure force in the liquid. The expansion of the combustion product gasses leads to a condition sometimes referred to as the quasi-static pressure, a uniform, subsonic pressure event. Since the buildup of the quasi static pressure is a much slower event than the blast wave, it is affected by both the vent area of the container and the compressibility of medium within the tank.

In addition to the pressure effects of the HEI-T detonation, the projectile can cause structural damage by the removal of material through impact of its fragmented explosive casing. Fragments from the 23mm HEI-T are relatively small, usually well below 0.05 lbs and are irregular in shape. Because of their irregular shape, the fragment of a 23mm HEI-T do not travel well through liquid (high drag) and there is some evidence that several feet of water is sufficient to effectively stop them (Reference 1).

## **2. TEST AND EVALUATION ISSUE**

### **2.1 Issue**

Is the C-17 wing vulnerable to structural damage from a 23mm high explosive incendiary - tracer (HEI-T) projectile impacting a wing fuel tank?

### **2.2 Measure of Evaluation (MOE)**

The measure of evaluation will be the likelihood of a reduction of load carrying capability or failure of the C-17 wing resulting from (1) loads analytically applied to the C-17 wing which have been derived from the results of C-130 and Boeing 707 testing and (2) damage analytically applied directly to the C-17 wing which have been collected from the results of C-130 and Boeing 707 testing.



### 3. TEST AND EVALUATION APPROACH

Three damage mechanisms can be expected from the 23mm HEI-T projectile impacting a C-17 wing tank: impulsive shock pressure loading to tank structural surfaces from the blast wave, "quasi-static" uniform pressure loading within the tank from expansion of detonation products, and removal/failure of structure from fragment impact. The effect of each failure mechanism on a large wing tank will be investigated using C-130 and Boeing 707 wing tanks as surrogates for the C-17 wing tanks. The approach of this test and analysis program is to test C-130 and Boeing 707 wing tanks against the 23mm HEI-T threat, measure the resulting damage, pressure history, and structural response in order to determine by comparison and detailed analysis, the vulnerability of the C-17 wing tank under the same conditions. There are two methods in this approach that will be conducted concurrently using the same ballistic test shots: an empirical and an analytical method.

#### 3.1 Analytical Method

The first, analytical method, is to use the surrogate tests to generate data that will be used to develop a prediction model of damage to the C-17 wing. There are seven steps to this method:

- STEP 1: The analytical method will begin with ballistic tests of a 23mm HEI-T against a C-130 wing tank. The pressure history inside of the C-130 wing tank, the response of the tank structure to this pressure, and the damage caused by all mechanisms of the 23mm HEI-T will be measured and analyzed along with existing data on pressure effects in fluid and structural response.
- STEP 2: The second step of the analytical method is to build a model, from the data taken in step 1, for predicting hydrodynamic loads from a 23mm HEI-T projectile detonating in a large wing tank. The model will be used to predict damage to a 707 wing tank under conditions similar to the 707 ballistic tests.
- STEP 3: The third step of the analytical method is ballistic testing of a Boeing 707 wing tank to collect data on the pressure history inside of the tank, the response of the tank structure to this pressure, and the damage caused by all mechanisms to the wing tank.
- STEP 4: The data generated in the 707 ballistic tests will be compared to the predictions to provide an assessment of the model accuracy.
- STEP 5: The model will be modified, if necessary, using the data generated from the 707 tests.
- STEP 6: The model will be applied to the C-17 wing to analytically determine the hydrodynamic loads, structural response, and damage calculated for a 23mm HEI-T impacting and detonating in the wing tank of a C-17.

**STEP 7:** The damage results determined by the model will be input into a finite element analysis of the C-17 wing to determine any loss of structural load capability.

### **3.2 Empirical Method**

The second method of the approach, the empirical method, is to demonstrate that the C-130 and 707 wings are less structurally robust than the C-17 wing. Then, by applying the damage measured from C-130 and 707 wing testing to a finite element analysis of the C-17, any loss of structural load capability can be determined. Any loss of load capability will be conservative due to the C-17 being more structurally robust than either the C-130 or 707. There are six steps to the empirical method:

- STEP 1:** The first step in this method will be to conduct a detailed study to analyze all of the structural features of the C-130, 707, and C-17 wing tanks to assess the relative structural robustness of each wing tank. This will include comparison of all structural members such as the spar, skin, internal frames, bulkheads, etc. as well as the overall loading capability of the wing. It is expected that the C-17 wing tanks will prove to be more structurally robust than either the C-130 or 707 wing tanks.
- STEP 2:** The next step in the empirical method is to test the 23mm HEI-T against a C-130 inboard wing tank and measure the resulting damage physical damage to the tank structure. This data will be obtained concurrently with the analytical method pressure and strain data utilizing the same C-130 wing tank shots described in section 3.1.
- STEP 3:** Damage collected in the C-130 wing tank tests will be applied to the C-17 finite element analysis to determine the structural response of the wing with this level of damage.
- STEP 4:** The next step in the empirical method will be to test the 23mm HEI-T against a 707 inboard wing tank and measure the resulting damage physical damage to the tank structure. This data will be obtained concurrently with the analytical method pressure and strain data utilizing the same 707 wing tank shots as described in section 3.1.
- STEP 5:** Damage collected in the 707 wing tank tests will be applied to the C-17 finite element analysis to determine the structural response of the wing with this level of damage.
- STEP 6:** The final step in the empirical method is to analyze the finite element analysis response of the C-17 wing to damage collected during the C-130 and 707 wing tanks tests. Any loss of structural capability will be considered conservative (for vulnerability of the wing) based on the study outlined in the first step.

### 3.3 Test Objective

The test program objective is to collect data on the pressure distribution on the surfaces of the tank from the impact and detonation of a 23mm HEI-T, the strain response in the structure to this loading, and physical damage to the tank from all effects of the threat. There will be two phases of the test program: Phase I will be the C-130 wing tank tests and Phase II will be the Boeing 707 wing tank tests.

#### 3.3.1 Phase I Test Objective

The objective of Phase I is to collect data on the pressure distribution on the surfaces of a C-130 inboard wing tank from the impact and detonation of a 23mm HEI-T, the strain response in the structure to this loading, and the physical damage to the tank from all effects of the threat.

#### 3.3.2 Phase II Test Objective

The objective of Phase II is to collect data on the pressure distribution on the surfaces of a Boeing 707 wing tank from the impact and detonation of a 23mm HEI-T, the strain response in the structure to this loading, and the physical damage to the tank from all effects of the threat.

### 3.4 Data Requirements

#### 3.4.1 Data Requirements Associated with Phase I MOE

Removal of structure by fragments, pressure within the tank, and response of the tank to pressure are believed to be the primary failure mechanisms that will occur from the ballistic event.

The dynamic pressure at locations within the tank and near tank surfaces (described in section 3.4.2) is needed to quantify the maximum overpressure and total impulse of the blast wave that reaches structural wing tank members from the detonation of the 23mm HEI-T round.

The static pressure within the ullage and fluid of the tank are needed to determine the build up of static pressure within the tank and the loading that this pressure exerts on the tank structure.

The strain in the structural members of the wing tank (locations described in section 4.2.2) is needed to quantify the response of the wing tank structure to the pressures within the tank.

The location and amount of wing tank material damaged or removed by fragments from the 23mm HEI-T round is needed to quantify the loss of structure of the tank section.

The velocity of the round is needed to calculate the distance the round will travel into the tank before detonation and confirm proper impact conditions/round function.

A baseline pressure and strain response is necessary to understand how the tank begins to respond to a static pressure load, so a pretest pressurization to 1.5 times the operating pressure of the tank will be recorded.

### 3.4.2 Phase I Instrumentation

Specific data requirements and gage locations have been determined only for the first shot of Phase I and will be adjusted after analysis of the data from the first shot.

A series of dynamic pressure transducers will be mounted to record the pressure history at locations within the wing tank. Kistler pressure transducers, with a  $1.0 \times 10^{-5}$  response time and 0 - 5000 psi pressure range, will be sampled at 1 MegaHZ for 0.05 seconds (from -0.01 to 0.04 seconds after projectile impact) and then at 20 KHZ from 0.04 to 0.74 seconds). The transducers will be mounted on probes placed through the tank walls and attached to a rigid frame in Range 3 to decouple the acceleration of the tank structure from the gage response. The transducer probes will be bent into position with a large radius to minimize acceleration affects of the shock wave on the probe. The transducers themselves will be oriented towards the calculated detonation point of the round in order to measure pressure normal to the shock wave.

A total of fourteen dynamic pressure transducer probes will be placed through the upper wing skin to record the pressure at locations described in Figure 3.1. The two transducers at the 1/2 chord point (one at 63 inches from the inboard edge, one at 81 inches) and the two transducers located six inches from the front spar, will measure pressure at a depth of 1.0 inch from the upper wing skin. The remaining two transducers at the 1/2 chord point will measure pressure at a depth of 1/2 of the tank (for each respective location). The eight transducers located along the WS 54 and 72 frames, 1/3 chord points, will measure pressure at a depth of 6 inches below the upper wing skin and 6 inches above the lower wing skin respectively.

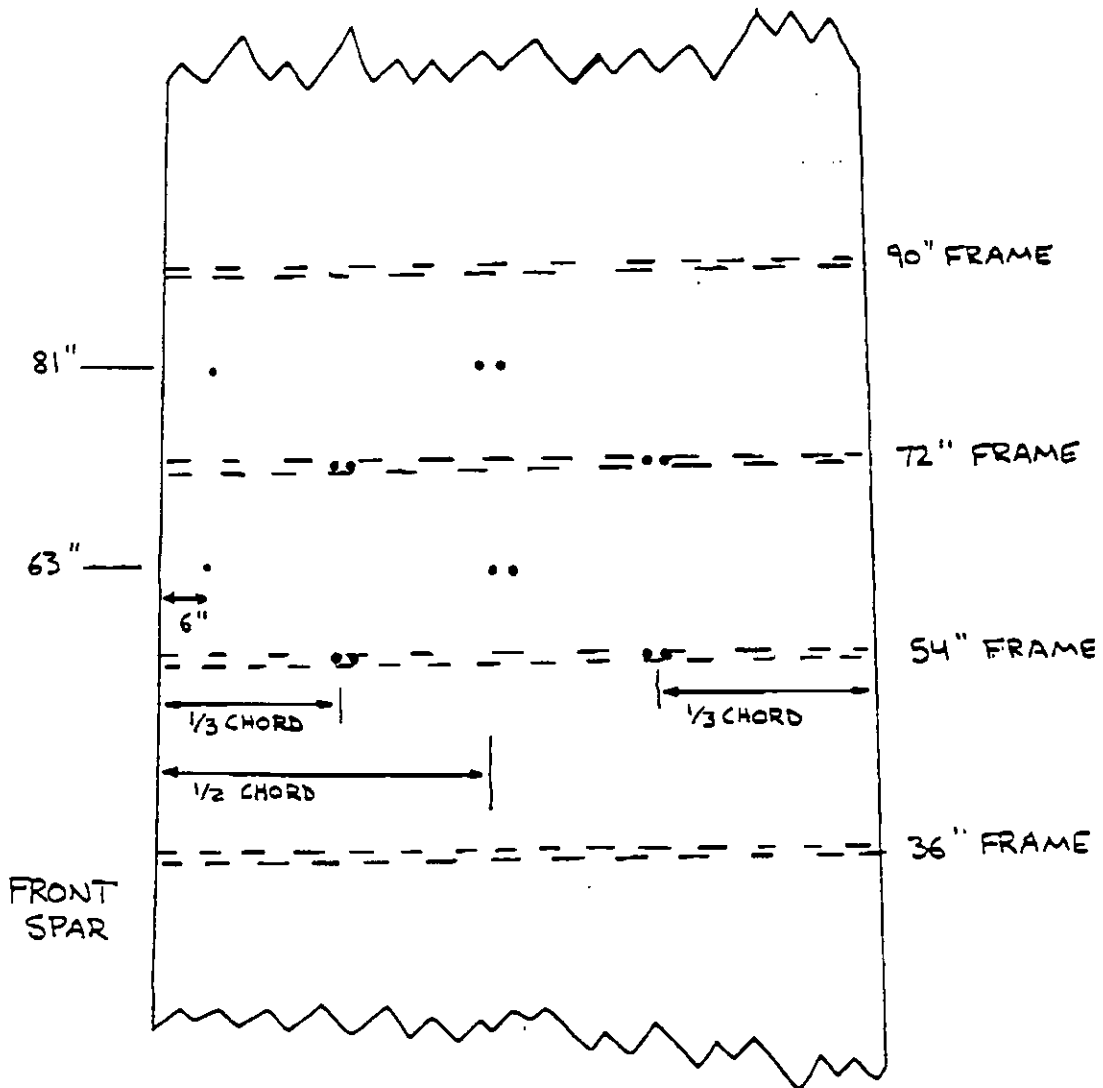

Figure 3.1 Pressure Probes Through Upper Wing Skin.

One dynamic pressure transducer will be placed through the center of each bulkhead to measure the pressure at 0.5 inch from the bulkhead surface. Two dynamic pressure transducers will be placed 0.5 inch through the front spar at 63 inches and 81 inches from the inboard shown in Figure 3.2.

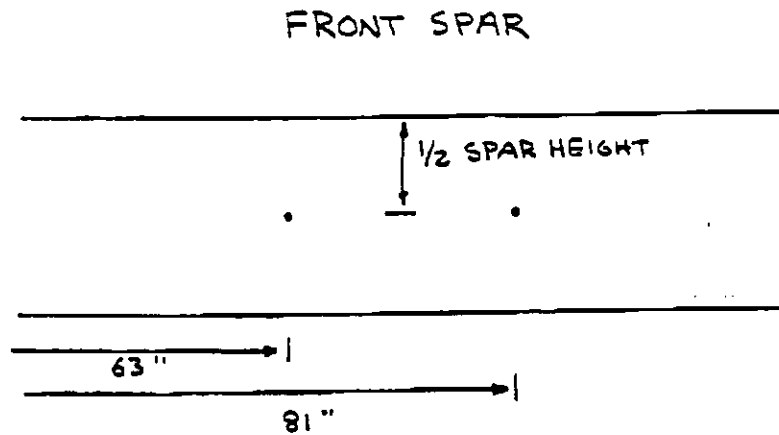

Figure 3.2 Pressure Probes Through Front Spar.

Two static (strain gage) transducers will be mounted on the inboard bulkhead of the tank and sampled at 1-5 KHZ. The top transducer will be used to measure static pressure in the ullage of the tank and the lower transducer will measure static pressure in the liquid.

A total of 80 of strain gages will be mounted on the surfaces of the wing tank and selected internal frames. 40 of the gages (circled) will be sampled at 1 MegaHZ. The remainder of the gages will be sampled at 1-5 KHZ. A series of 22 strain gages will be mounted on both the upper and lower wing surfaces as shown in Figure 3.3.

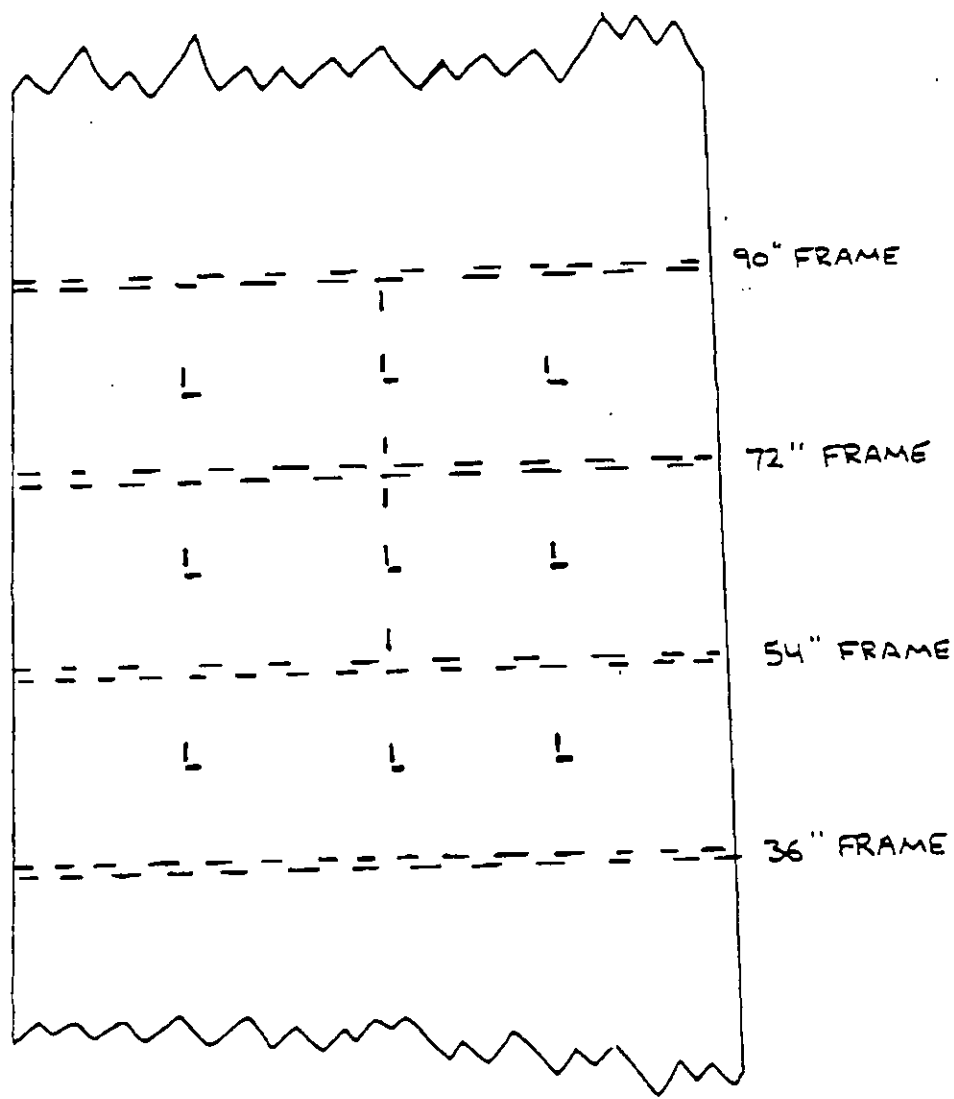

Figure 3.3 Upper and Lower Wing Skin Strain Gage Locations.

A series of 12 strain gages will be located inside of the tank on the upper and lower sections of the frames at WS 54 and 72 as shown in Figure 3.4.

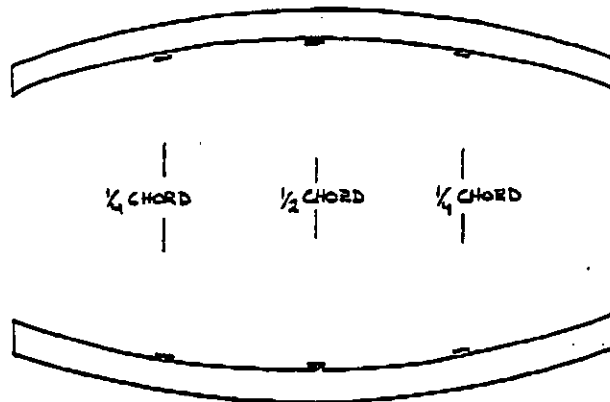

Figure 3.4 Internal Frame Strain Gage Locations.

Six strain gages will be mounted on each bulkhead of the tank as shown in Figure 3.5.

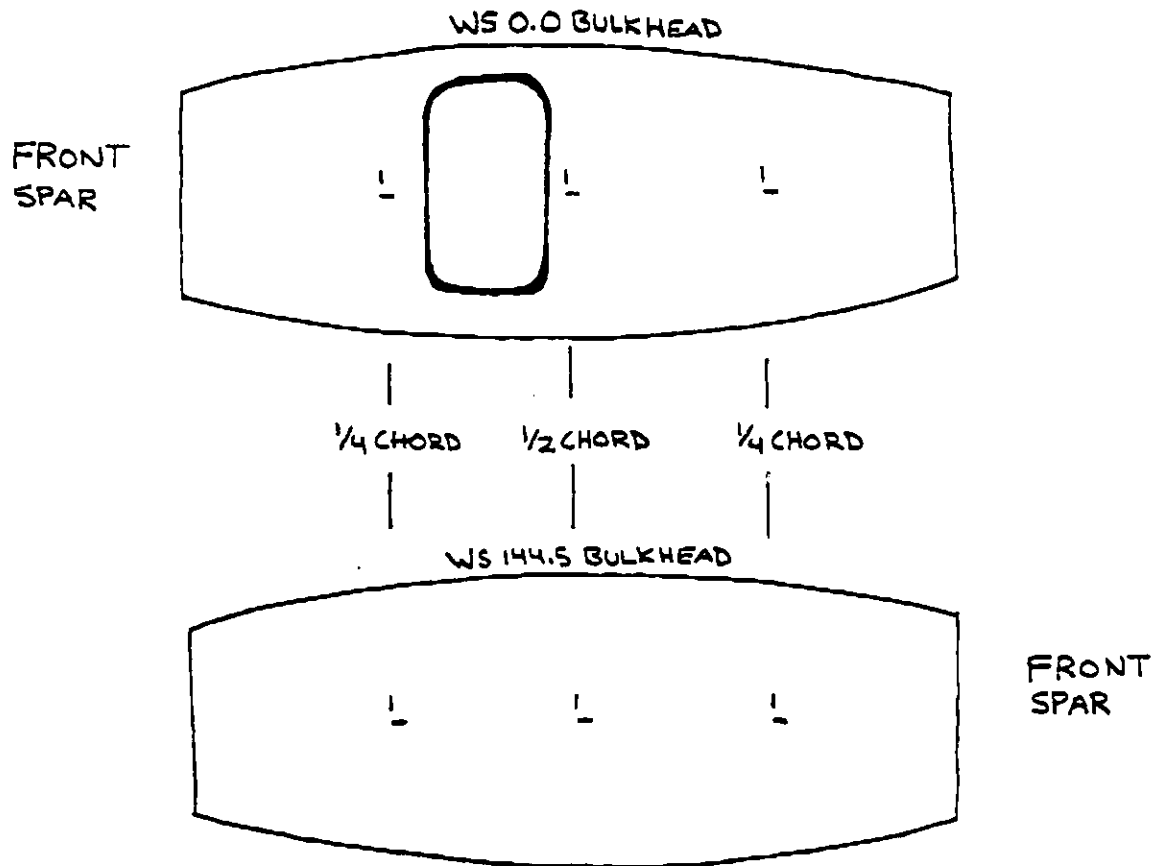

Figure 3.5 Bulkhead Strain Gage Locations.



Six strain gages will be mounted on each spar of the tank as shown in Figure 3.6.

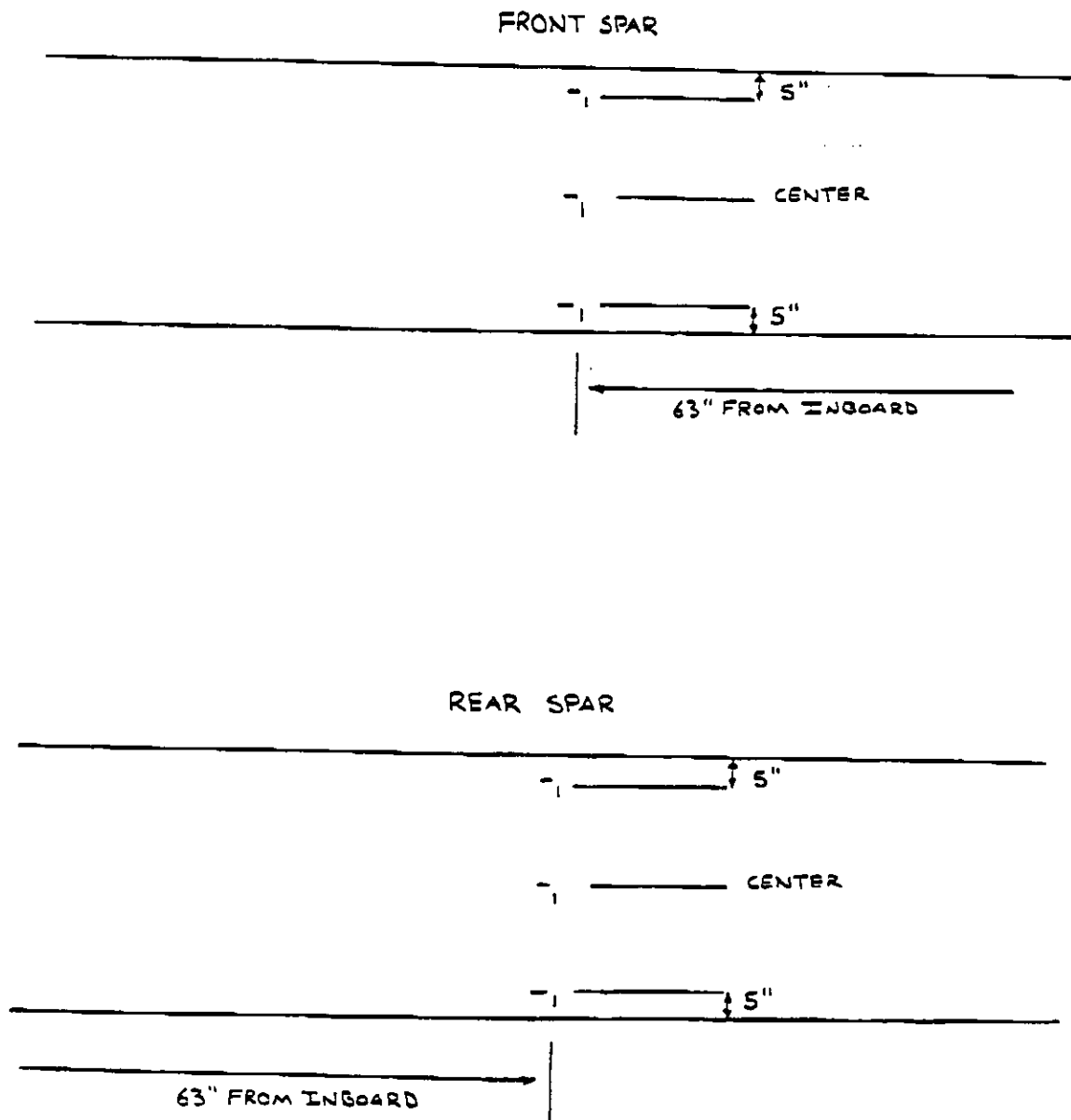

Figure 3.6 Spar Strain Gage Locations.

A breakwire placed through the rifling of the barrel and a breakpaper on the impact point of the lower wing skin will be recorded to measure the velocity of the round. The breakpaper on the tank will also trigger the data collection sequence for the other instruments.

#### **3.4.3 Phase I Optical and Audio Records**

Two video cameras will record the events of each shot. The first camera will view the lower wing skin and impact area. The second camera will view the upper wing skin of the tank.

Still photographs of the wing tank and set up will be taken before and detailed damage photographs after each shot.

#### **3.4.4 Data Requirements Associated with Phase II MOE**

Data requirements for Phase II will be determined after detailed analysis of the data collected during Phase I.

#### **3.4.5 Phase II Instrumentation**

Instrumentation for Phase II will be determined after detailed analysis of the data collected during Phase I.

#### **3.4.6 Phase II Optical and Audio Records**

Optical and audio for Phase II will be determined after detailed analysis of the data collected during Phase I.

#### **3.4.7 Damage Assessment Records**

Damage assessment records for both phases of this test program will consist of a comprehensive visual assessment of physical damage to the test article after each shot. All sections of the test article will be carefully searched for any removal of material by fragment damage, cracking, denting, or any other permanent physical distortion. Any observed damage will be measured and recorded along with its location on the overall structure. Photographs of each damage area will be taken.

### 3.5 Test Setup

#### 3.5.1 Threat Characteristics and Specifications

The threat munition that will be used for both phases of this test program will be the Soviet 23mm High Explosive Incendiary - Tracer (HEI-T) (Soviet Designation BZT) antiaircraft artillery projectile fuzeed with a MG-25 (ground-to-air, delayed) fuze. The projectile is typically fired from single or multiple barrel antiaircraft artillery pieces including the Soviet ZSU-23-4. The projectiles will be fired from a laboratory barrel and downloaded to achieve an impact velocity of 2200 ft/s. Specific details on the performance of the 23mm HEI-T are classified SECRET and can be found in Reference 2.

#### 3.5.2 Phase I Target Characteristics

The Phase I target will be a right hand C-130 inboard wing tank bounded spanwise between the WS 0.0 and WS 144.5 bulkheads, chordwise by the two (front and rear) wing spars, and top and bottom by the upper and lower wing skins. The wing tank will be plumbed to hold up to 100% water and a pressure of up to 5 psi. The tank will be bolted to Range 3 at the inboard edge and cradled at the outboard edge as shown in Figure 3.7.

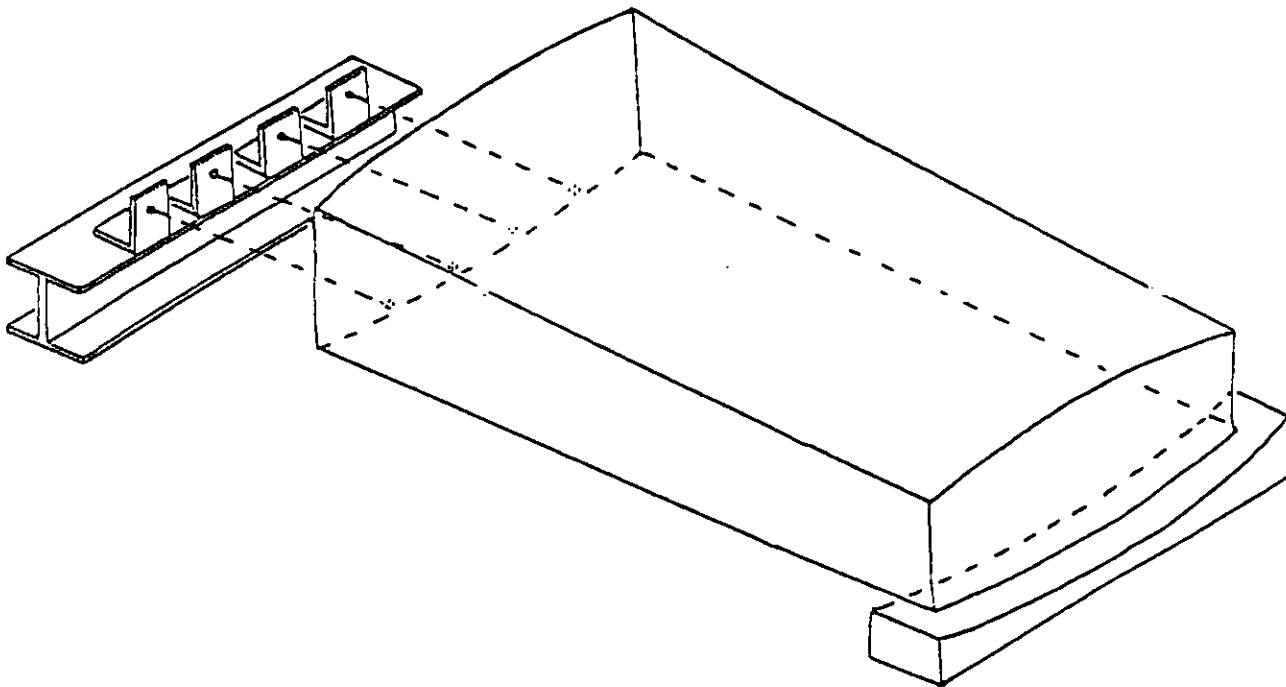

Figure 3.7 Test Article Mounting.

### 3.5.3 Phase I Test Conditions and Matrix

Three shots are planned for Phase I and are described in Table 3.1.

TABLE 3.1  
Phase I Shot Matrix.

	SHOT #1	SHOT #2	SHOT #3
Impact Location	WS 63 Chord 1/2	WS 99 Chord 1/2	WS 63 aft of front spar 2"
Threat	23mm HEI-T MG-25 Fuze	23mm HEI-T MG-25 Fuze	23mm HEI-T MG-25 Fuze
Obliquity	0°	0°	0°
Impact Velocity	2200 ft/s	2200 ft/s	2200 ft/s
Tank Fluid Level	65%	100%	100%
Tank Pressure	0 psi	0 psi	0 psi

### 3.5.4 Phase II Target Characteristics

The Phase II target(s) will be one or more 707 wing tanks that will be determined by Phase II data requirements and the results of Phase I.

### 3.5.5 Phase II Test Conditions and Matrix

Phase II tests conditions and matrix will be determined by Phase II data requirements. The scope and shot matrix will most likely be similar to the Phase I shot matrix.

### 3.6 Analytical/Evaluation Assessment Procedures

Analytical/evaluation assessment procedures will be developed by Douglas Aircraft Company under contract to the C-17 Program Office.

#### 4. DOCUMENTATION

All data collected during both phases of the program will be recorded and documented within one week of each test. Analysis of the data and comparison to the C-17 aircraft will be the responsibility of the C-17 Program Office. A draft final report will be prepared by WL/FTVS and submitted to the C-17 Program Office 30 days after the receipt of the data analysis from the C-17 office.

## 5. REFERENCES

- <sup>1</sup> USAAMRDL-TR-75-32, "Reduction of Army Helicopter Fuel Tank Vulnerability to 23mm HEI-T Projectile", U.S. Army Air Mobility Research and Development Laboratory, August 1975.
- <sup>2</sup> TB-381-5-1, "Foreign Materiel Catalog, Volume I - Conventional Ordnance Materiel", Dept of Army Technical Bulletin, 10 September 1971.

MEMO TO: ASC/YCT <sup>(M)</sup>  
YC  
AFPEO/TA  
IN TURN

09 NOV 1992

**SUBJECT: Closure of OSD Concerns Regarding C-17 Live Fire Test Article**

1. Reference OUSD(A)/DDDR&E (LFT) memorandum, dated 15 July 1992 (attached).

2. The intent of this memo is to status the issues raised in the referenced memo regarding the adequacy of the C-17 Wing Leading Edge (WLE) test article to a 12.7mm API test threat:

a. **External Airflow:** External pressure distributions in the area of projectile impact will be replicated as required to obtain valid test results to the extent that the test facility will allow. Airflow fences will be used to adjust pressure distributions, as required. Pressure rakes will be used to verify pressures. (Closed)

b. **Internal Airflow:** Internal airflow is extremely difficult to measure or model. However, internal airflow will be duplicated "in the macro sense" by duplicating on the test article the open space associated with the piano hinge on the maintenance access panels found on the fixed leading edge (this area has been identified as the primary air entry point on the fixed leading edge). The engineering analysis of the C-17 WLE dry bay internal airflow was presented to IDA representatives on 5 Nov, as was the plan to replicate this airflow in the WLE test article. (Closed)

c. **Spar Web Thickness:** Suggested test will be accomplished. Testing commenced 26 October 1992. (Closed)

d. **Stiffener Cross Section:** Analyses have been conducted and given to Mr Tom Julian of OUSD(A)/DDDR&E (LFT) on 26 August 1992. Discussions are ongoing. (Open)

e. **Incendiary Functioning through Titanium:** Data from ASD TR 77-19 Vol II shows no impact on round functioning if impact obliquity is less than 30 degrees. No shotlines require greater than 30 degree obliquity through the titanium slat skin. (Closed)

f. **Front Spar Material:** The alloy used in the test article will be the same as that found in the production wing. (Closed)

3. The C-17 SPO intends to close item 2d. prior to testing the WLE article with 12.7mm API. The full-up WLE test is scheduled to commence 29 January 93.

4. Regarding the other issues raised in the referenced memo (hydrodynamic ram, larger test threats), the C-17 System Program Office intends to address these concerns through a separate set of tests and analyses.

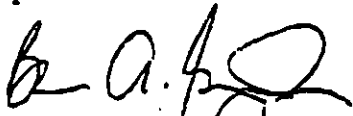

**BRUCE A. GUZOWSKI**  
Acting Branch Chief, Test and Evaluation  
C-17 SPO

1 Atch  
15 Jul 92 Memo





ACQUISITION

OFFICE OF THE UNDER SECRETARY OF DEFENSE  
WASHINGTON, DC 20301

15 July 1992

MEMORANDUM FOR AIR FORCE PROGRAM EXECUTIVE OFFICER FOR TACTICAL  
AND AIRLIFT PROGRAMS (AFPEO/TA)  
THROUGH: DIRECTOR, TEST AND EVALUATION, OUSD(A)

SUBJECT: Suitability of C-17A Wing Leading Edge Surrogate for  
Vulnerability Testing for Dry Bay Fires

We have received your July 1, 1992 memorandum, same subject (attached). It lists the changes that have recently been made to the C-17A leading edge test article currently being constructed at WPAFB, OH. It also revealed one additional difference in construction between the test article and the actual wing which we were not aware of before (front spar material). At your request, we have assessed the impact of these changes on the adequacy of the test article in the assessment of the vulnerability of the C-17 to dry bay fires.

It is our opinion that the referenced changes will not lessen the testing risks already described in our earlier correspondence. However, the test article would continue to be of some use in helping determine the wing leading edge dry bay fire vulnerability of the aircraft to 12.7 mm API rounds under the conditions described in our earlier correspondence. The test article is not suitable for 23 mm and larger API rounds, nor for HEI rounds of any caliber. In addition, the test article is not suitable for determining hydrodynamic ram effects.

Although the test article may be suitable for use with 12.7 mm API rounds, there is still some risk associated with this assessment for the 12.7 mm itself. To reduce this risk, we suggest that:

- The external airflow (or pressure) at the point of entry of the projectile, and at other major openings to the dry bay, should be duplicated as closely as possible during the test. The airflow internal to the dry bay should also be duplicated, at least in a macro sense.

- A separate test series should be run to determine the effect of various spar thicknesses on the wound size suffered by the spar upon impact with the projectile. This test series is necessary because the spar web thickness used in the proposed test article is an average of the spar thicknesses used on the

actual C-17A wing. The tests would resolve whether the thickness of the spar is an important factor in how much damage it sustains upon projectile impact, and on the resultant fuel leak.

- Prior to the using the test article, the Air Force should demonstrate by pre-test or fully documented engineering calculations that variances in API round functioning and wound size due to stiffener cross section, shape, and contact area differences between the test article and the actual C-17A wing will have insignificant impact on the test results.

- The Air Force should document that the API round's incendiary functioning on the titanium slat skin will be the same in the test article as on an actual C-17A slat.

- The Air Force should verify that the front spar material on the test article is identical to that on the actual wing. (Until we received your July 1 memorandum stating that this material would be changed from 6061-T6 to 7075-T6511, it was our understanding that the test article spar material was the same as that on the actual wing.)

It continues to be our concern that the Air Force is focusing its interest too narrowly: on a portion of the wing leading edge, on dry bay fire as a damage mechanism, and on 12.7 mm AP<sup>T</sup> rounds as the threat. Note that all of the above concerns relate to test article's adequacy for assessing only 12.7 mm AP<sup>T</sup>, for only dry bay fire initiation and only for a small portion of the highly variable geometry of the leading (and trailing) edge. Although the proposed test could be a part of a well-rounded vulnerability assessment program, it is not an adequate substitute for one.

To adequately address the vulnerability of the C-17A, larger threats must be assessed using a more production-representative test article. This article could be used not only to address larger expected threats, but other damage mechanisms (such as hydrodynamic ram) and fire initiation in locations on the aircraft other than in the wing leading edge.



James F. O'Bryon  
Deputy Director  
Test & Evaluation  
Live Fire Testing



OFFICE OF THE UNDER SECRETARY OF DEFENSE

WASHINGTON, DC 20301-3000

ACQUISITION

EXECUTIVE SUMMARY

MEMORANDUM FOR DEPUTY UNDER SECRETARY OF DEFENSE (ACQUISITION)

FROM: DIRECTOR, STRATEGIC AND SPACE SYSTEMS *BR Schmitt 10/25/92*  
DIRECTOR, TEST AND EVALUATION *10/23* *Adolphi*

SUBJECT: C-17 Live Fire Test (LFT)

PURPOSE: ACTION--To forward memorandum specifying Air Force requirements for C-17 LFT.

DISCUSSION.

- o The FY93 Authorization Act identifies the C-17 as a system requiring LFT, and states "the Secretary of Defense shall require that sufficiently large and realistic components and subsystems that could affect the survivability of the C-17 system be made available for any alternative [to a full aircraft] live fire test program."
- o S&SS/T&E position is that the Air Force must use a production representative wing for LFT. The Air Force proposed surrogate (C-141, etc, see informal Air Force proposal at attachment 2) is not an appropriate substitution, nor is the specially built nine foot section of wing at Wright-Patterson AFB.
- o Cost for this production representative wing is within the Service's BES for LFT (\$41 million in FY93-94). Attachment 3 presents costs for a production wing (Option 2) or a static test article wing (Option 3), which are less than the BES. Attachment 4 shows vulnerability reduction fixes, if required, including costs\* and the impact on the aircraft.  
*\* Not funded in BES, necessarily. BSS*
- o The wing is to be subjected to 12.7mm and 14.5mm API & HEI projectile ballistic tests. Consideration should be given by the Air Force to testing with 20mm and 23mm projectiles. The Air Force concurs with this approach for projectiles.

RECOMMENDATION:

Sign the memorandum to the Air Force (TAB 1).

PREPARED BY: Dr. Milton J. Minneman/S&SS(AS)/X56188 *MJM*  
LTC Lewis/T&E(A&SP)/X57245/October 23, 1992

APPROVED BY: DD S&SS(AS) *10/23*  
DD T&E(A&SP) *10/23*



ACQUISITION

THE DEPUTY UNDER SECRETARY OF DEFENSE  
WASHINGTON, DC 20301

MEMORANDUM FOR THE SECRETARY OF THE AIR FORCE  
ATTENTION: AIR FORCE ACQUISITION EXECUTIVE

SUBJECT: C-17 Vulnerability Program

I have completed my review of the Air Force's plans for assessing the vulnerability of the C-17 aircraft. In doing so, I have taken into account the threat to the C-17 and the C-17 specification for survivability/vulnerability.

I have concluded that the limited testing currently planned by the Air Force (12.7mm API at a wing leading edge surrogate test article) is insufficient.

The design and configuration of the aircraft should have the highest practical level of protection against threats that cannot readily be detected, evaded, or countered, consistent with the planned operation of the C-17, as well as cost, schedule, and performance implications. In this regard, testing should be limited to assessment of those "cheap kill" single-shot vulnerabilities for which there are potential practical fixes of modest cost and minimal weight and fuel reduction penalties.

The tests would determine the vulnerability of the aircraft to (1) ram-induced structural failure and (2) dry bay fire initiation and sustainment in the wings. The test program should be in two phases: The first would establish whether vulnerabilities exist. If vulnerabilities do exist, the second phase would test the proposed modifications to address them. The wing is to be subjected to 12.7mm and 14.5mm API & HEI projectile ballistic tests, in accordance with the threat described above. Testing is to be performed first with 12.7mm API, then HEI, and those higher caliber projectiles in ascending order until the test article has been rendered unsuitable for additional testing in the opinion of the Director, Test and Evaluation, OUSD(A). Consideration should also be given to testing with 20 and 23 mm projectiles.

The testing should therefore be accomplished on a larger, more production-representative C-17 test article, to address priority vulnerability issues for the expected threat. Use of the static test article, with the dry bays reconfigured to be representative of a production wing, offers one option to enable testing of the priority issues at a reasonable cost and potential return on investment. All systems present on an actual operating aircraft in the leading edge dry bays and trailing edge dry bays would need to be installed into the test article. Use of this

static test article rather than a new C-17 production wing is contingent upon a prior acceptance of the static test article as adequately representing the C-17 wing for this ballistic testing. If the static test article is inadequate for this purpose, you should test a C-17 production wing.

In addition to these tests, analyses should be performed to assess the vulnerability of the aircraft configured with its representative operational cargo loads, as well as casualties to personnel.

I request that you submit to me within 30 days implementation plans to accomplish the above including budget, funding plan, schedule, and test range requirements.

MEMORANDUM FOR THE SECRETARY OF THE AIR FORCE  
ATTENTION: AIR FORCE ACQUISITION EXECUTIVE

SUBJECT: C-17 Vulnerability Program

I have completed my review of the Air Force's plans for assessing the vulnerability of the C-17 aircraft. In doing so, I have taken into account the threat to the C-17 and the C-17 specification for survivability/vulnerability.

I have concluded that the limited testing currently planned by the Air Force (12.7 mm API at a wing leading edge surrogate test article) is insufficient.

The design and configuration of the aircraft should have the highest practical level of protection against threats that cannot readily be detected, evaded, or countered, consistent with the planned operation of the C-17, as well as cost, schedule, and performance implications. In this regard, testing should be limited to assessment of those "cheap kill" single-shot vulnerabilities for which there are potential practical fixes of modest cost and minimal weight and fuel reduction penalties.

The tests would determine the vulnerability of the aircraft to (1) ram-induced structural failure and (2) dry bay fire initiation and sustainment in the wings. The test program should be in two phases: The first would establish whether vulnerabilities exist. If vulnerabilities do exist, the second phase would test the proposed modifications to address them. The wing should be subjected to 12.7 and 14.5 mm API & HEI projectile ballistic tests, in accordance with the threat described above. Consideration should also be given to testing with 20 and 23 mm projectiles.

Since there is no current ability to analyze ram induced structural failure, this determination must be done via actual test. As a first step, recommend the use of a surrogate wing for the following reasons; several large aircraft wings are available, cost would be low, provides near term results and gives a good basis for follow on C-17 tests if deemed necessary. Once surrogate tests are complete, request you provide an assessment of test results and your recommendation for C-17 tests if required.

If the analysis indicates the need for testing on a larger, more production-representative test article than the planned wing leading edge mock up, consider the static test article. Its use with the dry bays reconfigured to be representative of a production wing, offers one option to enable testing of the priority issues at a reasonable cost and potential return on investment. All systems present on an actual operating aircraft in the leading edge dry bays and trailing edge dry bays would need to be installed into the test article. Use of the static test article rather than a new production wing is contingent upon acceptance of the static test article as adequately representing the wing for this ballistic testing. If the static test article is inadequate for this purpose, you should consider procuring and testing a production wing.

(cargo and passengers) ← Need to be here

I request that you submit to me within 90 days implementation plans to accomplish the above to include budget, funding plan, schedule, and test range requirements.

# ADDITIONAL C-17A VULNERABILITY TEST OPTIONS BENEFITS — COSTS

OPTION	BENEFITS	COSTS* (FY 93 \$M)	
		TEST ARTICLE	TEST CONDUCT
PRODUCTION WING WITH PYLONS	ADDRESSES ISSUES: RAM Induced wing failure, dry bay fire, and pylon fire initiation/propagation  WITH HIGH FIDELITY	37.5	6.2
PRODUCTION WING WITHOUT PYLONS	ADDRESSES ISSUES: RAM Induced wing failure and dry bay fire  WITH HIGH FIDELITY	32.8	5.4
SECTION OF PRODUCTION WING WITH INBOARD FUEL TANK AND RESIDENT SYSTEMS	ADDRESSES ISSUES: RAM Induced wing failure and dry bay fire  WITH HIGH FIDELITY BUT LIMITED TO INBOARD TANK AND ITS ADJACENT DRY BAYS; WILL NOT INCLUDE VARIATION IN TANKS AND DRY BAYS IN REMAINDER OF WING	30.8	3.8
WING FROM STATIC TEST ARTICLE WITH SYSTEMS ADDED TO DRY BAYS	ADDRESSES ISSUES: RAM Induced wing failure and dry bay fire  BUT THERE ARE RISKS TEST ARTICLE WILL BE: - Irreparably damaged from static tests - Not fully production representative	13.3	5.4
WING FROM STATIC TEST ARTICLE WITHOUT SYSTEMS	ADDRESSES ISSUE: RAM Induced wing failure  BUT THERE ARE RISKS TEST ARTICLE WILL BE: - Irreparably damaged from static tests - Not fully production representative	4.0	3.4

\* In order of magnitude cost estimates include spares and contractor support.

# EXAMPLE VULNERABILITY REDUCTION SYSTEMS COST SUMMARY

POTENTIAL VULNERABILITY	EXAMPLE SOLUTION	SYSTEM WEIGHT ESTIMATES AND (CHANGE IN FUEL CAPACITY)	LIFE CYCLE COSTS* FOR 120 AIRCRAFT FLEET (FY 93 \$M)
HYDRODYNAMIC RAM INDUCED STRUCTURAL DAMAGE TO WING	FUEL MANAGEMENT PROGRAM FOR COMBAT MISSIONS	60 LBS.	\$16.7
	RAM ATTENUATION LINER FOR FRONT SPAR IN ALL TANKS	130 LBS. (-190 LBS. FUEL)	\$27.1
	FUEL MANAGEMENT PROGRAM FOR COMBAT MISSIONS + RAM ATTENUATION LINER IN FEED AND RESERVOIR TANKS	100 LBS. (-60 LBS. FUEL)	\$26.5
DRY BAY FIRES	AUTOMATIC FIRE EXTNGUISHERS	150 LBS.	\$30.7
PYLON FIRES	AUTOMATIC FIRE EXTINGUISHERS	15 LBS.	\$2.5

\*Rough order of magnitude cost estimates to equip all 120 aircraft assuming installation at production.



Basic disagreement between AF and OSD is over the adequacy of the test articles.

AF wants to test dry bay fire initiation using a 9ft <sup>mock up</sup> surrogate section of the wing. Test will start in Jan 93.

OSD says this is insufficient, and that the test must be done on a full-size, production representative wing.  
*not production representative*

With respect to ram-induced structural failure testing, the AF wants to first test a surrogate wing (e.g. C-130) to determine if additional testing on a larger more production representative C-17 wing is necessary.

OSD will only accept results from testing a production representative C-17 wing.

We are still convinced that the AF phased approach is reasonable and prudent. However, the FY93 Authorization Act requires SECDEF to determine what are sufficiently large and realistic components and subsystems for Live Fire Testing.

## C-17 Live Fire Test

The Live Fire Test (LFT) program originated in 1983

- OSD Director for Defense Testing & Evaluation proposed a new joint test and evaluation initiative
- Joint Live Fire program chartered by OSD in 1984 for US Army programs
- Chapter 139 of Title 10, US Code calls out weapon system testing requirements
  - Serves as a basis to define objectives of Live Fire Test and Evaluation (LFT&E)
  - Requires timely and thorough assessment of vulnerability/lethality of a system as it progresses through development
- C-17 was nominated in Jun 87 by the Air Force in response to an OSD request for live fire test candidates
- C-17 Vulnerability Analysis included as part of the program R&D contract
  - Assessed various threats as part of a comprehensive analytical computer model
  - The entire aircraft was modeled using Military Airlift Command (MAC) developed mission profiles
  - The model simulated threats/hostile environments and determined most vulnerable areas
  - This assessment was then used to help determine, as part of the aircraft design process, the physical location in the aircraft of critical components and separation required to enhance survivability
- C-17 LFT strategy was approved by OSD in Oct 89
  - Strategy based on building a full-scale test section of the aircraft wing
    - Actual production drawings and materials to be used for wing mock up
    - Mock up will include all fully operational subsystems (pressurized fuel lines, hydraulic lines, electrical wire bundles, ect)
  - Wright Research and Development Center (WRDC) at Wright-Patterson AFB is building the wing test article, accomplishing the tests, analyzing the data and reporting the test results
  - C-17 LFT incorporated into and is directed in the C-17 Program Management Directive (PMD)
  - LFT approved strategy is part of the C-17 Test and Evaluation Master Plan (TEMP) as directed by OSD
- Technical concerns and issues on LFT continue to be raised by OSD DDDR&E(LFT) and are being worked
  - Current concern over the MAC C-17 Concept of Operations and the commitment to deploy the aircraft into a "medium threat" environment
  - Identified threats in the new C-17 System Threat Assessment Report, 29 Mar 91, are inconsistent with approved LFT strategy
  - 8 Jul 91, Air Force responded to the most recent OSD concerns -- OSD review underway
  - C-17 LFT subsystem testing is currently ongoing
- OSD's 1 Nov 91 memo states it is not expected that a full up combat loaded aircraft will be subjected to LFT
  - Components and C-17 sections will be subjected to LFT on a prudent basis of expected benefit of the test weighed against the test cost
  - Level of testing in regard to threat munition and the size of the test sections is still under review

**POINT PAPER**  
**ON**  
**ADDITIONAL C-17 LIVE FIRE TEST FUNDING REQUIREMENTS**

- Current funded and budgeted C-17 R&D program does not include funds required to meet additional tests of full-scale production representative aircraft wing
- Proposed plan, which is still in the early stages of formulation, initially calls for testing of a surrogate wing section (not C-17) to assess hydrodynamic ram effects on large aircraft wing
  - Would provide a basis for determining if further testing would be required
  - Data collected would be analyzed and used to model C-17
  - Evaluation of surrogate and model would provide basis for establishing follow-on test approach and requirements
- C-17 program FY93 R&D funds expected to be used to complete surrogate wing testing -- estimate \$1M
- If follow-on hydrodynamic testing on a C-17 wing is determined to be required, use of the static test article wing after static tests are completed is seen as a cost effective alternative
- Initial assessment of the funds required to support hydrodynamic tests of a fully configured static wing -- estimate \$40M FY94 through FY96
  - FY94/95: Static wing repair and configuration to production like wing and test instrumentation installation -- \$18M for FY94, \$18M for FY95
  - FY 96: Transportation to test site, set up, tests with different size munitions, repair and reconfiguration, retests, data reduction and analysis, and final test report -- \$4M
  - Planned test completion third quarter FY96
- If determination is made that static wing is unacceptable or unable to be reconfigured to adequately represent a full-up production wing, an actual production wing from the assembly line would be required
  - Significant cost increase to procure an additional wing for follow-on tests
  - Delay/disruption of production aircraft if wing is pulled off assembly line to meet test schedule

BRIEFED  
TO  
AFPEO/TA

AUG 03 '92 13:06 DEPUTY FOR C17 WPAFB



# C-17 S/V PROGRAM REVIEW

27 JULY 1992

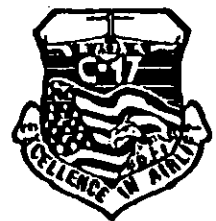

## **C-17 S/V PROGRAM**

**COMBAT/BALLISTIC TEST DATA SURVEY**  
**14.5 MM HEI PROJECTILE EVALUATION**  
**23 MM HEI SENSITIVITY STUDY**  
**RESPONSE TO OSD LETTER**  
**ACTIONS PENDING OUTCOME OF TECH ISSUES**

- **SUPPLEMENTAL TEST/ANALYSIS**
- **SURROGATE TANK TEST**
- **STATIC ARTICLE WING TEST**

**COMPLETE 23 MM HEI STRUCTURAL ANALYSIS**  
**(DAC)**



# COMBAT/BALLISTIC TEST DATA SURVEY

**PURPOSE: TO COLLECT & EVALUATE DATA TO ASSIST IN  
VALIDATING C-17 LFT PROGRAM**

**APPROACH (SURVIAC TASK):**

- SURVEY COMBAT DATA
- SURVEY BALLISTIC TEST DATA
- EVALUATE 'SIMILAR' DATA
- HELP TO DEFINE EXPECTED LFT RESULTS

**RESULTS: 'REAL LIFE' & PREVIOUS TEST INPUTS**

**PRODUCT: ANNOTATED BRIEFING & DATA INPUTS**

**SCHEDULE: 3 MONTHS EFFORT + 1 MONTH FOR REPORT**

**CONTRACT START DATE: 1 SEPTEMBER**

**WORK COMPLETION DATE: 1 DECEMBER**



## 14.5 MM HEI PROJECTILE EVALUATION

**PURPOSE: CHARACTERIZE ROUND & DETERMINE TEST SUITABILITY**

**(NOTE: PROGRAM REQUIRES 100 ROUNDS TO CONDUCT)**

**(SERIES A: 6 SHOTS - 3 AL, 3 - COMPOSITE TARGET)**

- **FUZE FUNCTIONING DETERMINATION**

**IF YES ON AL - 10 SHOTS TO CHARACTERIZE FUNCTION**

**IF YES ON COMPOSITE - 10 SHOTS TO CHARACTERIZE FUNCTION**

**SERIES B: CHARACTERIZATION OF ROUND**

**DATA: FRAGMENT MASS, VELOCITY, ANGLE  
DISTRIBUTION, BLAST OVERPRESSURE, FIREBALL  
INTENSITY & DURATION**

**SERIES C: SELECTED 23 MM HEI COMPARISON SHOTS**

**PRODUCTS: (1) DATA FOR ASSESSMENT OF SPECIMEN  
ADEQUACY**

**(2) DATA TO SUPPORT VULNERABILITY ANALYSIS**

**TESTS COMPLETED: 6 WEEKS AFTER ARRIVAL OF ROUNDS**



# 14.5MM HEI PROJECTILE EVALUATION WING LEADING EDGE SPECIMEN ASSESSMENT

**PURPOSE: ASSESS WLE SPECIMEN ADEQUACY FOR THREAT**

**APPROACH: (SURVIAC TASK SUPPORT)**

- REVIEW CHARACTERIZATION DATA
- FOR SELECTED SHOTLINES:
  - PREDICT DETONATION POINT
  - PREDICT DAMAGE
- ASSESS RESULTS

**PRODUCTS: (1) EVALUATION OF TEST ARTICLE ADEQUACY**

**(2) PREDICTED DAMAGES**

**(3) SUGGESTED TEST CONDITIONS**

**ANALYSIS COMPLETED: 2 WEEKS AFTER RECEIPT OF TEST DATA**





# **C-17 VULNERABILITY REDUCTION TRADE STUDY 23 MM HEI SENSITIVITY**

**PURPOSE: TO EVALUATE POSSIBLE VULNERABILITY  
REDUCTIONS (23 MM HEI PROJECTILE THREAT)**

**APPROACH (DAC CONTRACT):**

- **EVALUATE BASELINE VULNERABILITIES**
  - **23 MM HEI - 6 IMPACT ORIENTATIONS**
  - **3 KILL/DAMAGE CATEGORIES**
- **REEVALUATE WITH AT LEAST 1 DESIGN 'FIX'**
  - **CALCULATE VULNERABILITY INCREMENT**
  - **CALCULATE COST, WEIGHT, PERFORMANCE, R & M**

**PRODUCT: REPORT & RECOMMENDATIONS**

**SCHEDULE: CONTRACT START - 15 SEPTEMBER  
STUDY COMPLETE - FEBRUARY 93**



## TEST ARTICLE FIDELITY

### OSD LFT PARTIAL RESPONSE

- **CURRENT TEST ARTICLE NOT SUITABLE FOR 23 MM AND LARGER API ROUNDS NOR HEI ROUNDS OF ANY CALIBER**
  - **SPO - NEED GUIDANCE ON THREAT**
- **EXTERNAL AIRFLOW SHOULD BE DUPLICATED AS CLOSE AS POSSIBLE**
  - **SPO - WILL DUPLICATE AS CLOSE AS PRACTICAL**
- **NEED SEPARATE TEST TO EVALUATE SPAR THICKNESS VARIATION**
  - **SPO - WILL ACCOMPLISH**
- **AF NEEDS TO FULLY DOCUMENT CALCULATIONS TO VERIFY NO SIGNIFICANT IMPACT DUE TO STIFFENER SHAPE AND CONTACT AREA**
  - **SPO - DONE, WILL FORWARD TO OSD**
- **AF SHOULD DOCUMENT SAME FUNCTIONING OF API ROUNDS FOR TEST ARTICLE AND PRODUCTION SLAT SKIN**
  - **SPO - BETWEEN SLAT RIBS THICKNESS AND MATERIAL IDENTICAL**
- **AF VERIFY FRONT SPAR MATERIAL SAME AS PRODUCTION**
  - **SPO - MATERIAL IS THE SAME, PREVIOUSLY STIFFENER WAS DIFFERENT**

# TEST ARTICLE FIDELITY (CONT'D)



**SPO RESPONSE BY 29 JUL 92**

**NOT ADDRESSED BY OSD**

- **SURROGATE RAM TESTING (IDA HAS PROPOSED A RESPONSE)**

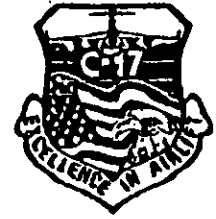

## **C-17 LFT PROGRAM WING LEADING EDGE ARTICLE**

### **MAINTAIN CURRENT WLE TEST ARTICLE DESIGN**

- **NO MODIFICATIONS**

- **STIFFENER MATERIAL CHANGE MADE MAY 92**

### **SUPPLEMENTAL ANALYSIS AND TESTING TO ADDRESS ISSUES:**

**"WHAT EFFECT DOES WEB THICKNESS, TANK SIZE AND STIFFNESS HAVE ON WOUND SIZE AND FUEL PRESSURE (LEAK RATE)"**

- **ANALYSIS COMPLETED**

- **WOUND SIZE AND LEAK RATE UNAFFECTED BY TANK SIZE AND STIFFNESS (FOR THE TIME OF INTEREST)**

- **WEB THICKNESS EFFECTS INCONCLUSIVE**

- **ANALYSIS TO BE FORWARDED TO OSD/LFT AND IDA**

### **TEST TO EVALUATE WEB THICKNESS EFFECTS ON WOUND SIZE**

- **SCHEDULE: INITIATE 1 AUG 92 FOR 3 MONTHS**

- **COST: \$60K**



# **C-17 LFT PROGRAM PROPOSED SURROGATE WING HYDRODYNAMIC RAM TESTING**

**REVIEW & COMPARE C-130, 707 WITH C-17 STRUCTURAL DETAILS**

- **MATERIALS, CONFIGURATIONS, DESIGN STRENGTHS, ETC**

**INSTRUMENT & TEST C-130 WING (23 MM HEI ?)**

**ANALYZE C-130 TEST RESULTS**

- **UTILIZE RESULTS TO PREDICT 707 RESPONSE**
- **INPUT C-130 DAMAGE INTO C-17 NASTRAN CODE TO PREDICT RESIDUAL STRENGTH (EXPECT TO BE CONSERVATIVE)**

**INSTRUMENT & TEST 707 WING**

**COMPARE RESULTS WITH PREDICTION**

**INPUT RESULTS INTO C-17 MODEL TO PREDICT C-17 RESPONSE,  
RESIDUAL STRENGTH**

**SCHEDULE: INITIATE 1 AUG FOR 8 MONTHS**

**COST: \$550K + ANALYSIS (\$300K)**



# **C-17 LFT PROGRAM PROPOSED STATIC WING TESTING**

**UTILIZE C-17 STATIC WING SEMI-SPAN TO EVALUATE**

- **HYDRODYNAMIC RAM AND LEADING EDGE FIRE**

**TEST ARTICLE PREPARATION**

- **REWORK WING AS NEEDED**
- **INSTALL LEADING EDGE SYSTEMS**
- **ONE COMPLETE SET OF SPARES**
  - **LEADING EDGE SYSTEMS, PANELS, DOORS, ETC**

**SCHEDULE**

- **CONTRACT GO-AHEAD TO DAC JUL 93**
- **SEMI-SPAN AVAILABLE NOV 93**
- **ARTICLE PREPARATION COMPLETE DEC 95**
- **SHIP TO NAWC, CHINA LAKE FOR TEST DEC 95**

**COST: \$25M DAC, \$3M TEST**



# C-17 LIVE FIRE TEST SCHEDULE

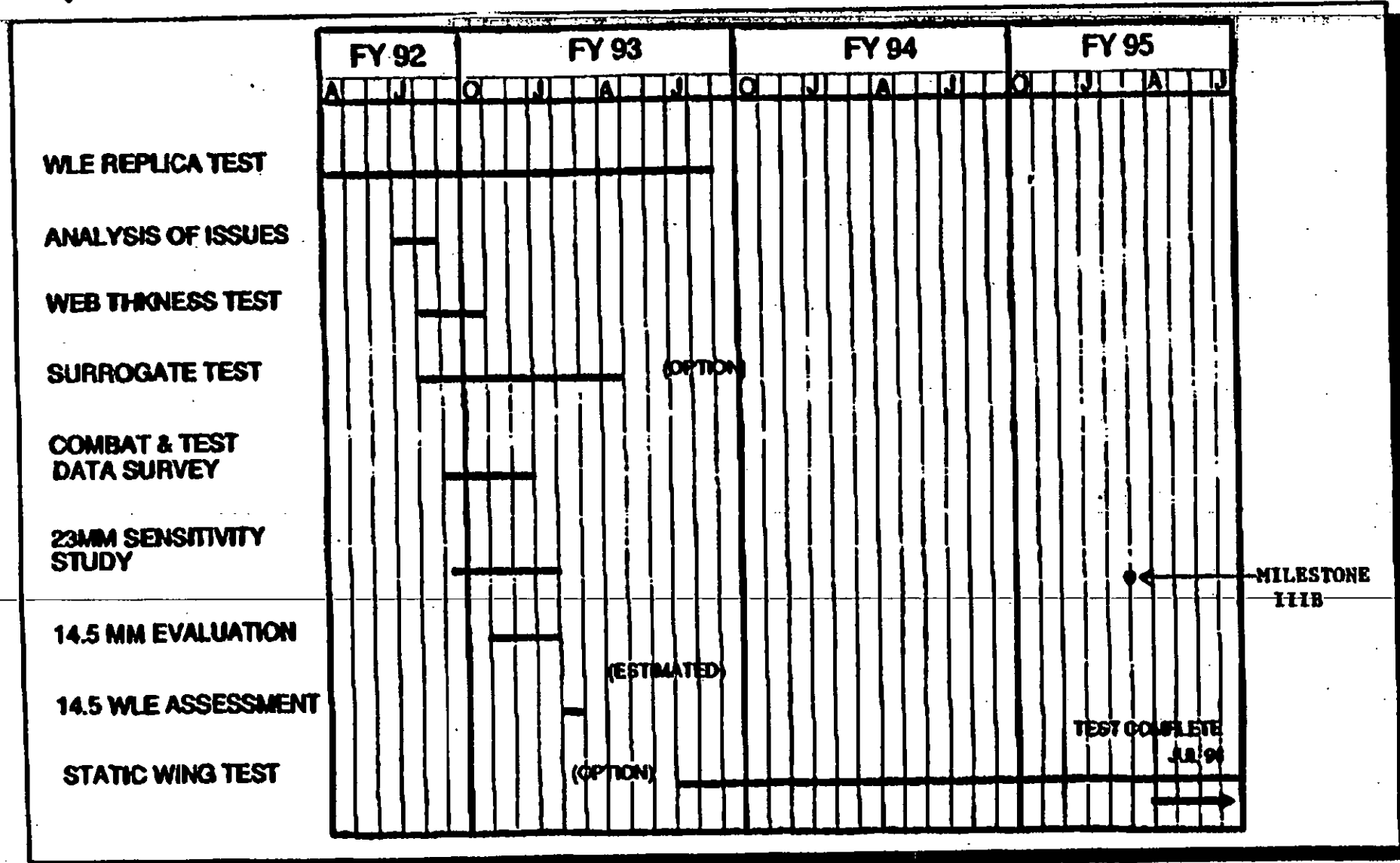



## **FUTURE ACTIONS**

**REVIEW SERVICE ENGINEERING STUDY OF TRANSPORT  
AIRCRAFT DIRECTED BY OSD?**

**PREPARE WAIVER AGAINST TESTING ENTIRE AIRCRAFT?**

**DEFINE THREAT TO BE TESTED**

**REVISE TEMP**





ACQUISITION

OFFICE OF THE UNDER SECRETARY OF DEFENSE  
WASHINGTON, DC 20301

July 24, 1992

MEMORANDUM FOR AIR FORCE PEO FOR TACTICAL AND AIRLIFT PROGRAMS  
(AFPEO/TA), MG E. FRANKLINTHROUGH: DIRECTOR, TEST AND EVALUATION *Adlyt* 27 JU

SUBJECT: Technical Issues with C-17 Vulnerability Test Program

This letter fulfills our response to a letter to IDA from Mr. Lynch (ASD/YCE), same subject, dated June 18, 1992. Our preliminary response is dated June 22, 1992 (Attached).

This letter addresses the adequacy of the overall vulnerability program of the C-17 planned by the Air Force. (Specifics relating only to the surrogate wing leading edge are addressed in our letter of July 15.) I summarize our conclusions below. A more detailed discussion follows this cover letter.

Mr. Lynch's letter focuses only on a small portion of the much larger issue of total aircraft vulnerability - that of the fidelity of the AF-proposed wing leading edge surrogate test surrogate. In doing so, the larger concerns that have been raised regarding the overall aircraft's vulnerability test and evaluation program have been ignored.

I reiterate them here:

o The threat that the Air Force proposes to primarily address is the 12.7 mm API round. However, as indicated in the C-17A STAR, the aircraft will not always be capable of avoiding all threats larger than 12.7 mm API. Past OSD guidance is that the service should test new systems to expected threats as identified in the STAR. Hence, the aircraft should be tested with higher order munitions than the 12.7 mm API threat.

o The Air Force is testing only a section of the wing leading edge dry bay for fire. There are other dry bay sections with other geometries in the wing that are also potentially vulnerable. In addition, fire initiation and sustainment in the pylon should also be addressed.

o The Air Force is addressing only the dry bay fire damage mechanism. For larger threats, hydrodynamic ram damage should also be tested.

o The wing leading edge surrogate is not adequate for testing threats larger than the 12.7 mm API round. In fact, there is some risk in using it as a surrogate for even the 12.7 mm API round. We have described these risks in earlier correspondence.

Our letter of July 15, 1992 makes clear that the recent modifications to the leading edge test article "will not lessen the testing risks".

There is little disagreement throughout the vulnerability modeling community that fire and hydrodynamic ram effects are some of the most devastating damage mechanisms for aircraft and are also among the most difficult to model. Hence, there is inordinate risk associated with attempting to extrapolate these effects across caliber and/or across aircraft designs.

Given that above, the current Air Force-proposed test program remains inadequate. While certain data obtained from testing the wing leading edge surrogate with 12.7 mm API rounds may be of interest, these data must be validated with similar testing on a more suitable, production-representative test article. Such an article could also be used to address larger expected threats, other damage mechanisms (such as hydrodynamic ram), and fire initiation in locations on the aircraft other than in the single wing leading edge section being simulated by the surrogate test article. I direct your attention to the details provided in the comments that follow for further insights into our conclusions.



James F. O'Bryon  
Deputy Director  
Test & Evaluation  
Live Fire Testing

Attachments

cc:  
S&SS (Dr. Schneiter)  
ASD/YCE (T. Lynch)

Comments on ASD/YCE Letter dated June 18, 1992  
Regarding C-17 Vulnerability Testing Issues

(Comments Relate to Wing Leading Edge Test Article Only.)

### Airflow

We agree that the external airflow and airflow within the leading edge dry bay is a concern. We originally raised this point because we did not know the details of the Air Force's proposed test, and wanted to ensure that the effects of both external and internal airflow were addressed. We suggest that, to achieve an acceptable airflow, it will be necessary to duplicate the external airflow (or pressure) at the point of entry of the projectile, and at other major openings to the dry bay. It will also be necessary to duplicate the internal airflow, at least in a macro-sense. I would draw your attention to the current plans to collect similar airflow data on the C-5A Galaxy as part of its recent upgrade to address the pylon fire issue.

We assume that the statement made in this document that "the wing LFT program will employ acceptable flow conditions for test purposes" means that these airflows will be measured on an actual aircraft, and they will then be duplicated to the best extent possible during the test.

### Differences in Spar Web Thickness on Wound Size and Leakage

We are puzzled by Paragraph 2.b. of this document. As pointed out in this document, we suggested that a separate test series be run to determine the effect of various spar thicknesses on the damage suffered by the spar upon impact with the projectile. The amount of damage to the spar will influence the rate of fuel leakage from the fuel tank into the dry bay.

We think it would be desirable to run this test series because the spar web thickness used in the proposed test article is an average of the spar thicknesses used on the actual C-17A wing. We think the test series we propose would be a reasonably inexpensive and simple test to resolve whether the thickness of the spar is an important factor in how much damage it sustains upon projectile impact, and on the resultant fuel leak.

We did not propose this test series to address the effects of spar web thickness on API round functioning. While we think this effect is significant, the Air Force-proposed test is conservative, i.e., the spar web in the test article will be at least as likely to cause functioning as the spar web in the aircraft. For this reason, we do not consider it necessary to

conduct an off-line test to determine the effect of spar web thickness on API functioning.

However, it is unclear from this document if the Air Force agrees that the effects of web thickness on wound size and fuel leakage are unknown. It is also unclear if they intend to conduct the proposed tests. If the Air Force can provide data that shows that the effect of spar thickness on spar damage is insignificant over the range of thicknesses used on the C-17A, we stand ready to review it. Otherwise, we think that the proposed test series will reduce the risks of obtaining misleading results from the fire tests.

#### Differences in Fuel Tank Size and Stiffness on Fuel Leak

We stand by our previous position that the effects of fuel tank size and stiffness on fuel leaks are largely unknown. Intuitively, one would expect that these factors may make a difference in the pressures generated in the tank when ballistically impacted. These pressures would affect the amount of fuel leaking from the wound, and thereby influence the probability of a fire being initiated and sustained in the wing leading edge dry bay.

In investigating the effects of tank size, we used a mathematical model that suggested that fuel tank volume may not be a significant contributor to the pressures built up inside the tank on ballistic impact with a 12.7 mm API round. However, this model had several potentially significant limitations.

For example, the model can predict the fluid pressure histories only in certain areas of the tank. It cannot predict the pressure history in the path of the cavitating bubble. The accuracy of the model is also questionable for the time period where there are multiple reflections from the tank walls. This is the period of primary concern for addressing the effects of differences in tank size and wall stiffness.

Hence, although preliminary results indicate that fuel tank volume does not play a significant role in tank fluid pressures and fuel leakage, there is still some risk that it is important.

#### Safe Distance Between Shot Lines and Test Article Stiffeners

In our briefing, we mentioned a "safe" distance that would minimize the effects of a stiffener or other test article "disparity" on the functioning of a 12.7 mm API round. This distance between the shot line and the disparity is based on the criterion that the 12.7 mm API projectile jacket would be completely through the target plate before the reflected shock

wave arrives back at the projectile. This would ensure that any differences in the reflecting object, e.g., a stiffener or rib, between the test article and the real wing would not affect jacket stripping.

We agree that this may be a conservative approach. We are currently searching for other information that may allow us to more accurately calculate the "safe" distance.

In addition, we are also searching for data that would enable us to take into account the effects of a disparity on wound size. The question here is how far does the shot line have to be from a stiffener to ensure that any differences in the stiffener will not affect the wound size.

The Air Force document outlines a series of arguments that the Air Force claims supports the assertion that the presence of nearby stiffeners has no effect on the functioning of an API round. Unfortunately, no references for these arguments were included in the document. We stand ready to review these references if the Air Force can make them available to us.

#### Differences in API Round Functioning on Titanium Slat

There is a question whether the impacting 12.7 mm API round will function the same on the proposed test article slat as it would on the actual C-17A wing slat. The problem is that the titanium surface of the slat on the production aircraft is chemically milled to a thickness of 0.063", while the titanium surface on the slat of the test article is a constant 0.071". The document mentions that a reference report shows no difference in functioning for 0.063" to 0.071" thickness in the range of expected impact angles. Unfortunately, the title of the referenced report is not included.

Our calculations indicate that for 0 degree obliquity angle, neither 0.063" nor 0.071" titanium will cause the 12.7 mm API round to function. However, for a 45 degree obliquity angle, the 12.7 mm API round will not function 84% of the time, and partially function only 16% of the time. By contrast, at the same obliquity angle, 0.071" titanium will cause the round to completely function 36% of the time, and cause partial function 64% of the time.

If an API round passes through the slat, dry bay, front spar, and into the fuel tank, there is a good chance that no fire will result since the incendiary may burn out before it can come into contact with fuel leaking from the tank. In such a case, the test article may provide results different from the actual aircraft wing.

## Hydrodynamic Ram Response of C-17A Wing to Higher Caliber Threats

The final item listed in the document is the potential for significant hydrodynamic ram damage when the C-17A wing is impacted with a 23 mm HEI round. We agree that there is a lack of experimental data regarding the effects of hydrodynamic ram on large transport aircraft wings. However, we think that the Air Force's proposal to test one or more surrogate wings taken from older transport aircraft, and then analytically extend the results of this testing to the C-17A wing may not be a good solution to the problem.

There is little doubt that such testing would be a useful addition to the vulnerability data base. However, we do not know how to form the analytical bridge that would be necessary to draw conclusions regarding the C-17A wing based on tests on other aircraft wings. We think that size alone is not a sufficient indicator of wing vulnerability.

Over the years, aircraft manufacturing processes and techniques have changed. Fasteners and metal alloys have become stronger and lighter. Aircraft designs have been optimized due to improved computational techniques. Aircraft machining, milling and metal hardening techniques have also radically changed. It is no longer necessary to deliberately overdesign structures to ensure they will not fail under all expected loads. The C-17A has presumably taken advantage of these advances to improve aircraft performance at lower weight and cost.

However, the wing's resistance to hydrodynamic ram damage depends on smaller scale strength properties of the wing's structure. Hence, this optimization may have improved the load-carrying capabilities of the wing, but may well have adversely affected its resistance to hydrodynamic ram damage.

We have considered the use of finite element models to bridge the analytical gap between the Air Force-proposed tests and an untested C-17A wing. According to a meeting of hydrodynamic ram modeling experts at WPAFB in February of this year, the modeling community does not have confidence in its ability to accurately model hydrodynamic ram effects of HEI projectiles on aircraft structures. This means that the analytical tools that would be required for the Air Force-proposed program to succeed are not yet available.

Another point to consider is what would be the Air Force response if this series of tests were conducted, and the surrogate wing catastrophically failed? Would the Air Force then be willing to test an actual C-17A wing to demonstrate that it wouldn't also

fail? Since the proposed test would not take place until late FY93 or 94, the need for obtaining and testing a wing so late in the EMD process could jeopardize Milestone III for the program. It is our opinion that planning for testing a production wing now will minimize turbulence in the program later.

#### Other Concerns About the Air Force Vulnerability Evaluation Program

As previously mentioned, we are concerned that the Air Force is largely focusing its interest on the fidelity of the wing leading edge test article. Although this article could be a part of a well-rounded vulnerability assessment program, it cannot be an adequate substitute for one.

To adequately address the vulnerability of the C-17A, larger threats must be assessed using a more suitable, production-representative test article. This article could be used not only to address larger expected threats, but other damage mechanisms (such as hydrodynamic ram) and fire initiation in locations on the aircraft other than in the wing leading edge.

\* \* \* \* \*



OFFICE OF THE UNDER SECRETARY OF DEFENSE  
WASHINGTON, DC 20301

ACQUISITION

June 22, 1992

*Fraser*  
MEMORANDUM FOR DIRECTOR, AIR FORCE TEST & EVALUATION (AF/TE)

SUBJECT: C-17 Vulnerability Program

The attached memorandum from the C-17 SPO was sent to our contractors at IDA on June 19 and then forwarded to me. It responds to some recent discussions which I have had with Dr. Fraser, Mr. Adolph and MG Franklin on the C-17 vulnerability test program. I have a couple of comments.

First, all correspondence should be addressed to this office and not be addressed to our contractors as this one was. The positions presented in our presentations to DUSD(A) are our positions, not those of IDA's. I appreciate the desire to open the lines of communications but this office should be the addressee on all correspondence relating to these issues to ensure clear lines of management on this and other programs.

Second, Mr. Lynch has specified a suspense of 2 weeks from our receipt of his letter. Our quick study of his letter indicates that we shall have some very substantial comments to his letter and hence, I cannot guarantee that our comments will be completed and back in two weeks. We shall respond as promptly as possible and I will keep you informed as to our progress.

Lastly, the letter fails to deal with the overall C-17 vulnerability issues which we have raised. It focuses almost exclusively on the adequacy of the Air Force's surrogate leading edge test article, and not on the more encompassing issues.

*Jim*  
James F. O'Bryon  
Deputy Director  
Test & Evaluation  
Live Fire Testing

Attachment

cc:

Dir, T&E

IDA, Tonnessen

C-17 SPO, Lynch



JUN 15 '92 08:08 DEPUTY FOR C17 WPAFB

P.2



**DEPARTMENT OF THE AIR FORCE**  
HEADQUARTERS AERONAUTICAL SYSTEMS DIVISION (AFSC)  
WRIGHT-PATTERSON AIR FORCE BASE, OHIO 45433-8533

REPLY TO  
ATTN OF: YCE

18 JUN 1992

SUBJECT: Technical Issues with the C-17 Live Fire Test Program

The Institute for Defense Analyses  
1801 N. Beauregard Street  
Alexandria, VA 22311-1772

1. On 26 May, representatives from the C-17 SPO and the Wright Laboratory, Flight Dynamics Directorate visited your facility to discuss the presentation by Mr O'Bryon to Major General Franklin and Mr Fraser. The objective of this visit was to discuss, in detail, the assessment regarding the fidelity of the wing LFT article, the adequacy of the test program, and the need for additional testing. This letter is intended to convey our understanding of your concerns with our test article and to request your views on some test alternatives.
2. With regard to the current test article, we understand that there are only five items which you believe have the possibility of impact on the validity of the testing. These are:
  - a. External airflow and airflow within the leading edge dry bay. The difficulty of simulating, on the ground, all of the many possible conditions that could exist in and around the wing leading edge was discussed. It was agreed that it is not possible to simulate all of these conditions and that the wing LFT program will employ acceptable flow conditions for test purposes.
  - b. Differences in spar web thickness on ballistic wound size and fuel leakage. The present spar web thickness in the LFT article is the average over the length of the production spar, XW 422-518. This thickness is great enough to cause jacket stripping of the 12.7mm projectile. The thicker web just outboard of the wing root will also cause jacket stripping, while the web thickness outboard of the test section may or may not guarantee jacket stripping.
  - IDA proposes a separate test series using a small tank with the thicker web, one of the same thickness as the LFT article, and a thinner web to quantify the uncertainty of incendiary jacket stripping and wound size with corresponding leak rates. If the test results show no differences in jacket stripping and flow rates, then this concern would be considered resolved.
  - c. Difference in full tank size and stiffness on fuel leaks. The IDA concern is that this effect is unknown. ASD is continuing to investigate previous wing ballistic test data for damage mechanisms and resultant dry bay effects. Results will be made available to IDA by 10 Aug 92. It is our understanding that the principal concern is stiffness with tank volume being an insignificant contributor to probability of fire.

d. Effects of different stiffness on fuel leaks. The difference is in the shape of the stiffeners ("Z" on the production wing and "L" on the ASD test article) and the contact area between the stiffeners and the skin. Initial inertia calculations indicate that the ASD test article stiffeners are very close to the stiffness of the production configuration (0.236 in. to the 4th power "Z" shape vs 0.227 in. to the 4th power "L" shape). IDA suggested that all shotlines should be four inches away from any stiffeners so that reflected shock waves would have no effect on a penetrating API's flight path or hole size. It is our belief at ASD that since (1) the magnitude of a lateral stress wave generated in the leading edge spar web due to bullet impact will be significantly attenuated (to less than 10 percent) by the time it reaches a stiffener (decreasing with radius squared), (2) the majority of the wave will be transmitted beyond the stiffener rather than reflected (discontinuity area ratio of 12 percent), (3) differences in impedance due to stiffener cross section differences will be small (since the test article has identical holes, fasteners, and spacing), and (4) any reflected wave will be attenuated somewhat before reaching the impact point, it follows that the magnitude of any differences in a reflected wave at the impact point, due to stiffener cross section differences, will be very small indeed. (Less than few percent of a few percent of a few percent!). That being the case, this too would result in an insignificant impact on the test results.

e. Difference in API functioning due to differences in Titanium skin thickness on slat. The four shotlines planned will impact in areas where the production skin will have been chemically milled to .071 or slightly thinner. The reference report used shows no difference in functioning for .063 to .071 thickness in the range of expected impact angles; therefore, this should be of no concern.

4. With regard to the IDA concern over potentially significant hydrodynamic ram damage due to a 23 HEI hit, ASD recognizes that there is a lack of data on large wings. Consequently, we are exploring the test of one or more currently available large surrogate fuel tanks instrumented for hydrodynamic ram and local shock effects. Also the effect of fuel level in the tanks will be determined. Shots would be at mid tank and near a spar. The test data would then be correlated with analytical models and used to predict C-17 responses. If this program showed no probability of catastrophic damage for the C-17, then additional tests would not be necessary.

5. We believe that the information presented above should lead you to the conclusion that the test article being constructed will, in fact, produce efficacious results. In the interest of timely finalization of the Live Fire program, we would appreciate your comments on the above within two weeks of receipt of this letter.

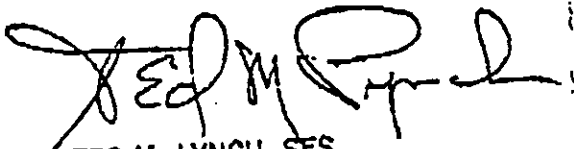

TED M. LYNCH, SES  
Technical Director  
C-17 SPO



OFFICE OF THE UNDER SECRETARY OF DEFENSE  
WASHINGTON, DC 20301

ACQUISITION

15 July 1992

MEMORANDUM FOR AIR FORCE PROGRAM EXECUTIVE OFFICER FOR TACTICAL  
AND AIRLIFT PROGRAMS (AFPEO/TA)  
THROUGH: DIRECTOR, TEST AND EVALUATION, OUSD(A)

SUBJECT: Suitability of C-17A Wing Leading Edge Surrogate for  
Vulnerability Testing for Dry Bay Fires

We have received your July 1, 1992 memorandum, same subject (attached). It lists the changes that have recently been made to the C-17A leading edge test article currently being constructed at WPAFB, OH. It also revealed one additional difference in construction between the test article and the actual wing which we were not aware of before (front spar material). At your request, we have assessed the impact of these changes on the adequacy of the test article in the assessment of the vulnerability of the C-17 to dry bay fires.

It is our opinion that the referenced changes will not lessen the testing risks already described in our earlier correspondence. However, the test article would continue to be of some use in helping determine the wing leading edge dry bay fire vulnerability of the aircraft to 12.7 mm API rounds under the conditions described in our earlier correspondence. The test article is not suitable for 23 mm and larger API rounds, nor for HFI rounds of any caliber. In addition, the test article is not suitable for determining hydrodynamic ram effects.

Although the test article may be suitable for use with 12.7 mm API rounds, there is still some risk associated with this assessment for the 12.7 mm itself. To reduce this risk, we suggest that:

- The external airflow (or pressure) at the point of entry of the projectile, and at other major openings to the dry bay, should be duplicated as closely as possible during the test. The airflow internal to the dry bay should also be duplicated, at least in a macro sense.

- A separate test series should be run to determine the effect of various spar thicknesses on the wound size suffered by the spar upon impact with the projectile. This test series is necessary because the spar web thickness used in the proposed test article is an average of the spar thicknesses used on the

actual C-17A wing. The tests would resolve whether the thickness of the spar is an important factor in how much damage it sustains upon projectile impact, and on the resultant fuel leak.

- Prior to the using the test article, the Air Force should demonstrate by pre-test or fully documented engineering calculations that variances in API round functioning and wound size due to stiffener cross section, shape, and contact area differences between the test article and the actual C-17A wing will have insignificant impact on the test results.

- The Air Force should document that the API round's incendiary functioning on the titanium slat skin will be the same in the test article as on an actual C-17A slat.

- The Air Force should verify that the front spar material on the test article is identical to that on the actual wing. (Until we received your July 1 memorandum stating that this material would be changed from 6061-T6 to 7075-T6511, it was our understanding that the test article spar material was the same as that on the actual wing.)

It continues to be our concern that the Air Force is focusing its interest too narrowly: on a portion of the wing leading edge, on dry bay fire as a damage mechanism, and on 12.7 mm API rounds as the threat. Note that all of the above concerns relate to test article's adequacy for assessing only 12.7 mm API, for only dry bay fire initiation and only for a small portion of the highly variable geometry of the leading (and trailing) edge. Although the proposed test could be a part of a well-rounded vulnerability assessment program, it is not an adequate substitute for one.

To adequately address the vulnerability of the C-17A, larger threats must be assessed using a more production-representative test article. This article could be used not only to address larger expected threats, but other damage mechanisms (such as hydrodynamic ram) and fire initiation in locations on the aircraft other than in the wing leading edge.



James F. O'Bryon  
Deputy Director  
Test & Evaluation  
Live Fire Testing



OFFICE OF THE UNDER SECRETARY OF DEFENSE  
WASHINGTON, DC 20301

ACQUISITION

June 29, 1992

MEMORANDUM FOR DIRECTOR AIR FORCE TEST AND EVALUATION (AF/TE)

SUBJECT: C-17 Vulnerability Testing

This morning, in a meeting which I attended here with Mr. Adolph, Dr. Schneider, MG Franklin, BG Caruana and others, MG Franklin indicated that the wing leading edge surrogate test article being constructed at WPAFB is ~~now being~~ modified in an attempt to be more representative of the actual C-17 leading edge being represented by the 9 foot section constructed by the Air Force.

As you know, we have raised concerns regarding the realism of this test article as the plans have evolved and hence, are very anxious to get a handle on these recent changes to assess their potential impact.

At the conclusion of the meeting this morning, I was directed to promptly assess these recent and perhaps ongoing changes and their potential impact on the testing with this test article. MG Franklin indicated that the Air Force would be willing to provide a complete description of each change to the test article. Our assessment will be completed within five working days of our receipt of these data.

If you have any questions, feel free to call me or my action officer, Dr. Michael Dante, DSN 227-5732.

A handwritten signature in black ink, appearing to read "James F. O'Bryon", is located below the typed name.

James F. O'Bryon  
Deputy Director  
Test & Evaluation  
Live Fire Testing

cc:  
DT&E  
AFPEO/TA, MG Franklin  
SAF/AQQ, BG Caruana  
C-17 SPO  
WPAFB, R. Lauzze

# FAX RENTAGON

SAF/AQQU

SOF, AIRLIFT  
AND TRAINING  
DIVISION

OFFICE: (703) 697-4138  
AV: 227-4138  
FAX: (703) 693-5335  
AV: 223-5335

FROM: Col Jim Donnelly

TO: Major Baumgartner ASD/VCA  
NAME ORG/OFFICE SYMBOL PHONE

2 PAGES (EXCLUDING COVER SHEET)

REMARKS:

24 Jun 92

Dr Schneiter (Strategic Systems Committee Chairman) has requested a meeting with SAF/AQQ and AFPEO/TA on Monday, 29 Jun 92 at 1000 to discuss the C-17 Vulnerability Program. He has provided the attached draft memo for our review and comment.

Please review the attached memo and provide your comments on Dr Schneiter's proposals by COB tomorrow. Specifically, Brig Gen Caruana wants to be prepared to discuss:

- 1) whether or not analyses to date address the latest issues raised (e.g., ram-induced structural failure, dry bay fire initiation and sustainment in the wings, aircraft configured with representative operational cargo loads, and casualties to personnel)
- 2) the feasibility of accomplishing the proposed analyses and test program
- 3) the costs for conducting vulnerability testing on a larger test article, including the static article option
- 4) the feasibility of meeting the 30-day suspense for implementation plan, budget, schedule, test range requirements, etc

We appreciate your help.

cc: AFPEO/TA

June \_\_, 1992

MEMORANDUM FOR THE SECRETARY OF THE AIR FORCE  
ATTENTION: AIR FORCE ACQUISITION EXECUTIVE

SUBJECT: C-17 Vulnerability Program

I have completed my review of the Air Force's plans for assessing the vulnerability of the C-17 aircraft. In doing so, I have taken into account the threat to the C-17 and the C-17 specification for survivability/vulnerability.

I have concluded that the limited testing currently planned by the Air Force (12.7 mm API at a wing leading edge surrogate test article) is insufficient.

The design and configuration of the aircraft should have the highest practical level of protection against threats that cannot readily be detected, evaded, or countered, consistent with the planned operation of the C-17, as well as cost, schedule, and performance implications. In this regard, testing should be limited to assessment of those "cheap kill" single-shot vulnerabilities for which there are potential practical fixes of modest cost and minimal weight and fuel reduction penalties.

The tests would determine the vulnerability of the aircraft to (1) ram-induced structural failure and (2) dry bay fire initiation and sustainment in the wings. The test program should be in two phases: The first would establish whether vulnerabilities exist. If vulnerabilities do exist, the second phase would test the proposed modifications to address them. The wing should be subjected to 12.7 and 14.5 mm API & HEI projectile ballistic tests, in accordance with the threat described above. Consideration should also be given to testing with 20 and 23 mm projectiles.

The testing should therefore be accomplished on a larger, more production-representative test article, to address priority vulnerability issues for the expected threat. Use of the static test article, with the dry bays reconfigured to be representative of a production wing, offers one option to enable testing of the priority issues at a reasonable cost and potential return on investment. All systems present on an actual operating aircraft in the leading edge dry bays and trailing edge dry bays would need to be installed into the test article. Use of this static test article rather than a new production wing is contingent upon a priori acceptance of the static test article as adequately representing the wing for this ballistic testing. If the static test article is inadequate for this purpose, you should consider procuring and testing a production wing.

In addition to these tests, analyses should be performed to assess the vulnerability of the aircraft configured with its representative operational cargo loads, as well as casualties to personnel.

I request that you submit to me within 30 days implementation plans to accomplish the above including budget, funding plan, schedule, and test range requirements.



**RESPONSE TO COL DONNELLY'S TELEFAX ON  
C-17 VULNERABILITY PROGRAM**

The following response is provided to the issues Brig Gen Caruana and Maj Gen Franklin will discuss with Dr Schneider on 29 Jun 92:

1) Whether or not analyses to date address the latest issues raised (e.g., ram-induced structural failure, dry bay fire initiation and sustainment in the wings, aircraft configured with representative operational cargo loads, and casualties to personnel).

a. There have been 6- and 26-view analyses performed on the C-17 configuration. These analyses were accomplished using the standard method approved by the Joint Technical Coordination Group on Aircraft Survivability (JTCC/AS). There were 2.13 million shotlines investigated. This analysis determined the vulnerable areas and the cause of that vulnerability. Threat sizes varied from 7.6mm through 23mm HEI. The only significant vulnerability for the 12.7mm API is in the leading edge dry bay due to fire. For larger rounds the kill mechanism is also fire.

b. As a part of the C-17 program detailed drawings and specifications have been prepared for crew protection against 12.7mm API rounds. This armor (1738 lbs) would be installed only in war times. Additional in-house studies have estimated that an additional 12,348 lbs of armor permanently installed would be required to provide similar protection for troops. To further protect the crew and troops from 23mm API rounds would require an additional 5314 and 37,044 lbs respectively of 1-inch thick titanium permanently installed. These large weight increases would have a very significant effect on payload/range capability.

c. With regard to hazardous cargo, 12.7mm API rounds would function at the fuselage skin well before the projectile would reach the cargo and, therefore, would not be a factor. For 23mm rounds the same amount of armor as required for the troops would be required to prevent significant damage. Further analysis does not appear warranted.

d. Early this year, a JTCC meeting was hosted at ASD to focus on the tools available for analyzing the effects of hydrodynamic ram on aircraft structure. It was the general consensus of the participants that no acceptable method is available at this time. The SPO, in conjunction with the Flight Dynamics Laboratory, has proposed a surrogate tank test program. This program would use fuel tanks from existing transport aircraft (i.e., C-130) and could be achieved quickly and with confidence in verifying the ram effects to the C-17. Using tanks from two different large transports and firing both 23 and 30mm HEI rounds, the tests could be accomplished in five months at a cost of \$500K. Results from these tests are easily analyzed for effects on the C-17 wing structure.

2. The feasibility of accomplishing the proposed analyses and test program. The feasibility of the analyses effort has been discussed above. The SPO was under the impression that OSD considered a wing leading edge test article satisfactory for determining probability of fire (with fire being generally accepted as the primary kill mechanism). The only question being the fidelity of the ASD test article. The Institute of Defensive Analysis (IDA) has, through Mr O'Bryon's office, identified five differences between the ASD article and the production article that have potential significance. Other differences were considered negligible. ASD sent a letter to IDA to clarify these differences and to attempt resolution. Comments have been requested. Barring complete analytical resolution, there are physical changes that can be made to make the ASD article more representative of the

production aircraft. These would delay the ASD test program by 32 to 80 weeks and would cost an additional \$155,000 to \$1,035,000 depending on what changes would be necessary. ASD has some concern over using the static article to test for hydrodynamic ram damage to wing structure. The static article will be tested to failure with one wing failing first. The question is whether or not there will be sufficient relatively undamaged structure remaining after the test. The SPO's preference is the surrogate tank test described above.

3. The costs for conducting vulnerability testing on a larger test article, including the static article option. The SPO has requested a cost estimate from DAC for "stuffing" the static article. This estimate should be available by 30 Jun 92. It is expected to be considerably higher than the \$13.3 million suggested by IDA. There is also an additional \$4.5 million cost estimate from IDA for conducting the test which ASD feels is adequate. The cost of a production wing would also be higher than IDA's estimate and more importantly would cause a significant disruption to the current production line.

4. The feasibility of meeting the 30-day suspense for implementation plan, budget, schedule, test range requirements, etc. The SPO can meet the 30-day suspense for planning, budgeting, and scheduling of the Live Fire Test Program, but only after receiving direction and definitive requirements for such a program. If the SPO is directed to use higher order threats than 12.7mm API against its test article, the number of shots will be significantly reduced. A series of 12.7mm API shots followed by a very few higher order shots would seem the most prudent course. Additionally, a few high order shots at large fuel tanks should resolve the ram issue.

# C-17 LFT PROGRAM

## HYDRODYNAMIC RAM DAMAGE SURROGATE TEST OPTIONS

---

### ISSUE:

Can the C-17 wing structurally withstand the impact of a 23mm HEI (or 30mm HEI) projectile, including the hydrodynamic ram effects.

### OVERALL APPROACH:

Ballistic testing with one or more surrogate aircraft wing sections to quantify the threat hydrodynamic ram effects on large transport aircraft wing tanks.

# C-17 LFT PROGRAM

## HYDRODYNAMIC RAM DAMAGE SURROGATE TEST OPTIONS

---

### OPTION 0

#### Approach:

- Three shots into C-130 wing tank
- Two shots mid-tank
- One shot next to spar
- No instrumentation

#### Expected Results:

- Quick look at 23mm HEI damage to large wing tank
- Simple, inexpensive test might answer issues

Estimated Cost
\$20K

Estimated Schedule
2 Weeks

# C-17 LFT PROGRAM

## HYDRODYNAMIC RAM DAMAGE SURROGATE TEST OPTIONS

---

### OPTION 1

#### Approach:

- Three shots into C-130 wing tank
- Two shots mid-tank
- One shot next to spar
- Pressure and strain instrumentation

#### Expected Results:

- Representative 23mm HEI damage to large wing tank
- Pressure/strain history for comparison to analysis

Estimated Cost
\$50K

Estimated Schedule
1 Month

# C-17 LFT PROGRAM

## HYDRODYNAMIC RAM DAMAGE SURROGATE TEST OPTIONS

---

### OPTION 2

#### Approach:

- Six shots into C-130 wing tanks
- 23mm and 30mm HEI
- Pressure/strain instrumentation

#### Expected Results:

- Quantify both 23mm and 30mm levels of damage
- Pressure/strain data for comparison to analysis

Estimated Cost
\$200K

Estimated Schedule
4-5 Months

# C-17 LFT PROGRAM

## HYDRODYNAMIC RAM DAMAGE SURROGATE TEST OPTIONS

---

### OPTION 3

#### Approach:

- Three shots into 707 wing tank
- Two shots mid-tank
- One shot next to spar
- Pressure/strain instrumentation

#### Expected Results:

- Quantify 23mm HEI damage to large wing tank
- Comparison to C-130 data would show trends

Estimated Cost
\$300K

Estimated Schedule
4-6 Months

C-17 LFT PROGRAM  
HYDRODYNAMIC RAM DAMAGE  
SURROGATE TEST OPTIONS

---

RECOMMENDATION:

OPTION 0 or 1

ANALYSIS OF RESULTS

PROPOSAL TO OSD

OPTION 2 and 3

Estimated Cost
Less than \$600K

Estimated Schedule
6-8 months



# C-17 LFT PROGRAM

## HYDRODYNAMIC RAM DAMAGE

### SURROGATE TEST OPTIONS

---

## Analysis

### Tasks

- Analyze each tank structure and predict damage.
- Compare test asset to C-17 and show how C-17 is less vulnerable to threat effects

### Options

C-17 Engineering  
ASIAC (WL/FIBR)  
Douglas  
Northrop

JUN 18 02 17:14 DEPT OF DEFENSE

**REPORT TO DUSD(A)**  
**ODLFT ASSESSMENT OF C-17A VULNERABILITY  
PROGRAM**

**MAY 29, 1992**

**MR. JAMES F. O'BRYON**

**DEPUTY DIRECTOR TEST AND EVALUATION/LIVE FIRE  
TEST**

# TOPICS

- **BACKGROUND**
  - Requirements
  - Threat
- **ISSUES IDENTIFIED BY ODLFT**
- **STRATEGY PROPOSED BY ODLFT**
- **ASSESSMENT OF DOUGLAS AIRCRAFT COMPANY'S VULNERABILITY ANALYSIS**
- **ASSESSMENT OF AIR FORCE PROPOSED BALLISTIC TESTS**
- **ADDITIONAL TEST OPTIONS**
- **EXAMPLE SOLUTIONS TO POTENTIAL VULNERABILITY PROBLEMS**
- **RECOMMENDATIONS**

# SYSTEM REQUIREMENTS

- **DELIVER OUTSIZED CARGO INTO AUSTERE, FORWARD AIRFIELDS**
- **REPLACE RETIRING C-130, C-141 AIRCRAFT, AND AUGMENT C-5**
- **CURRENT AIR FORCE POLICY STATEMENT (APRIL 1992)**
  - **Routinely operate in low threat environment**
  - **Occasionally operate in medium threat environment**
  - **Rarely operate in high threat environment**
  - **Employ threat avoidance and/or suppression**
  - **Risk management decisions by appropriate level of command**

# AIR FORCE THREAT DEFINITIONS

- **LOW THREAT**
  - Optically aimed AAA up to 0.51 caliber (12.7MM equivalent)
- **MEDIUM THREAT**
  - Low threat plus
  - AAA weapons greater than 0.51 caliber
  - Man-portable SAMs
  - Threat avoidance possible
- **HIGH THREAT**
  - Medium threat plus
  - Threat dispersion pattern which denies avoidance and requires penetration

## SUMMARY OF CARGO/TRANSPORT AIRCRAFT LOSSES

	U. S. Aircraft in Southeast Asia				Soviet Transport Losses in Afghanistan	U.S. Cargo/Transport Aircraft Damaged in JUST CAUSE
	Damages		Losses			
	C-130	Other Cargo/ Transport Aircraft*	C-130	Other Cargo/ Transport Aircraft*		
Small Arms/Automatic Weapons	170	323	6	6	?	15
AAA	3	8	3	0	?	0
Unknown Origin	28	55	13	22	?	0
Man-Portable SAMs	--	---	--	---	31	0
<b>TOTAL</b>	<b>201</b>	<b>386</b>	<b>22</b>	<b>28</b>	<b>31+?</b>	<b>15</b>

\*CV-2, C-7A, C-117D, C-123, C-124, C-104A, C-141, C-5A.

# COMPARISON BETWEEN DESIGN THREAT AND EXPECTED THREAT

- DESIGN THREAT - 12.7 MM API
- U. S. AIR FORCE REQUIREMENTS
  - Operate in "medium threat environment" including small arms, optically tracked AAA, hand-held IR missiles
- DIA APPROVED SYSTEM THREAT ASSESSMENT REPORT (LATEST STAR MARCH 1991)  

- AF PROPOSED VULNERABILITY TEST
  - Only 12.7 mm API rounds are to be fired at replica of small section of wing leading edge

# ISSUES IDENTIFIED BY ODLFT (SEPTEMBER 1988)

- THREAT MUNITIONS
- USER VULNERABILITY
- VULNERABILITY DUE TO CARGO
- VULNERABILITY IN DELIVERY AREA
  - Low Altitude Parachute Extraction System (LAPES)
  - Take-off/landing
  - Parked
- SYSTEM AND/OR COMPONENT ISSUES
  - Fuel system
  - Propulsion
  - Flight controls
  - Structure



# Possible Vulnerability Assessment Strategy for C-17A

		THREAT CLASSES INCLUDED IN STAR				
ISSUES		[REDACTED]	[REDACTED]	[REDACTED]	[REDACTED]	[REDACTED]
FUEL SYSTEM	DRY BAY FIRE	ANALYSIS BASED ON PAST TESTS	Ballistic Tests In Wing Section			THESE ISSUES GENERALLY NOT APPLICABLE TO THESE THREATS. PERTINENT ISSUES NEED TO BE IDENTIFIED.
	ULLAGE		OBIGGS Tests			
	RAM INDUCED STRUCTURAL FAILURE		Ballistic Tests In C-17A Wing			
PROPULSION	FIRE		Demonstration			
	UNCONTAINED ENGINE FAILURE		Analysis Based on Past Tests			
	ENGINE-FLAP SYNERGISM		Demonstration			
FLIGHT CONTROLS	SEPARATION		Analysis Based on Past Tests			
	DEGRADATION		Demonstration			
STRUCTURE/CONTROL SURFACES (COMPOSITE)			Analysis + Tests as Required*			
USER CASUALTIES			Analysis Based on Past Tests			
CARGO		Analysis + Tests as Required*			NOT APPLICABLE	
DELIVERY AREA		Analysis + Tests as Required*				
UNIDENTIFIED		Analysis + Tests as Required*				

\*As determined after review of analysis by Dir., LFT

# **ASSESSMENT OF DOUGLAS AIRCRAFT COMPANY'S VULNERABILITY ANALYSIS**

- **ODLFT/IDA CONDUCTED DETAILED REVIEW OF DAC'S ANALYSIS**
- **NO MAJOR DISCREPANCIES NOTED**
- **CONCERNS REMAINING**
  - **Limitations inherent in process — Failure Modes, Effects, and Criticality Analysis (FMECA) and 26 View Vulnerability Analysis**
  - **Some concerns being addressed by on-going DAC analyses and/or demonstrations**
  - **Some concerns unresolved**
    - **Verification of wing structure vulnerability via testing**
    - **User casualties (via analysis)**
    - **Vulnerability due to cargo (via analysis)**

# AIR FORCE-PROPOSAL C-17A WING LEADING EDGE TEST ARTICLE

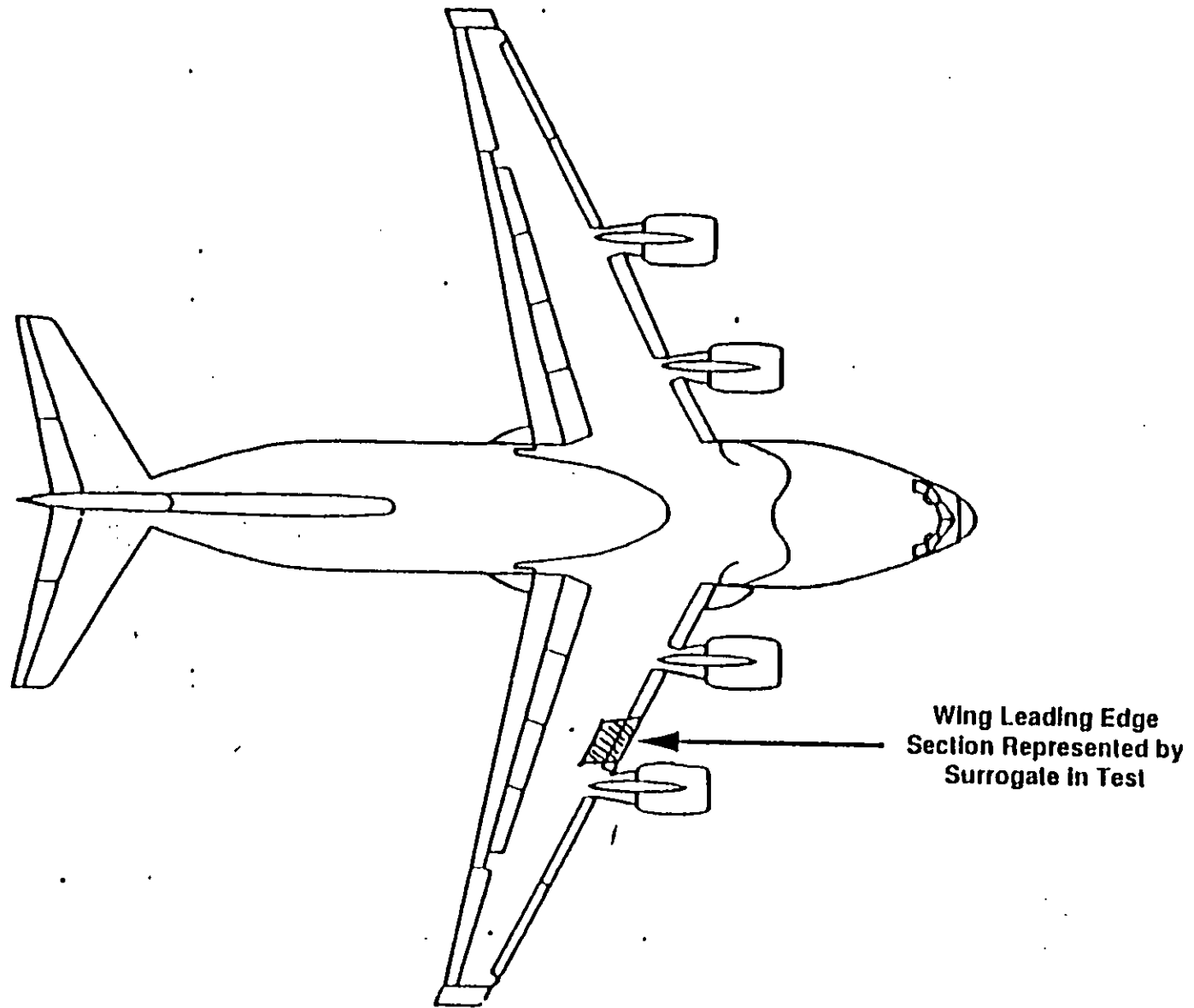

# C-17 PROGRAM WING LEADING EDGE TEST ARTICLE - CONCEPTUAL

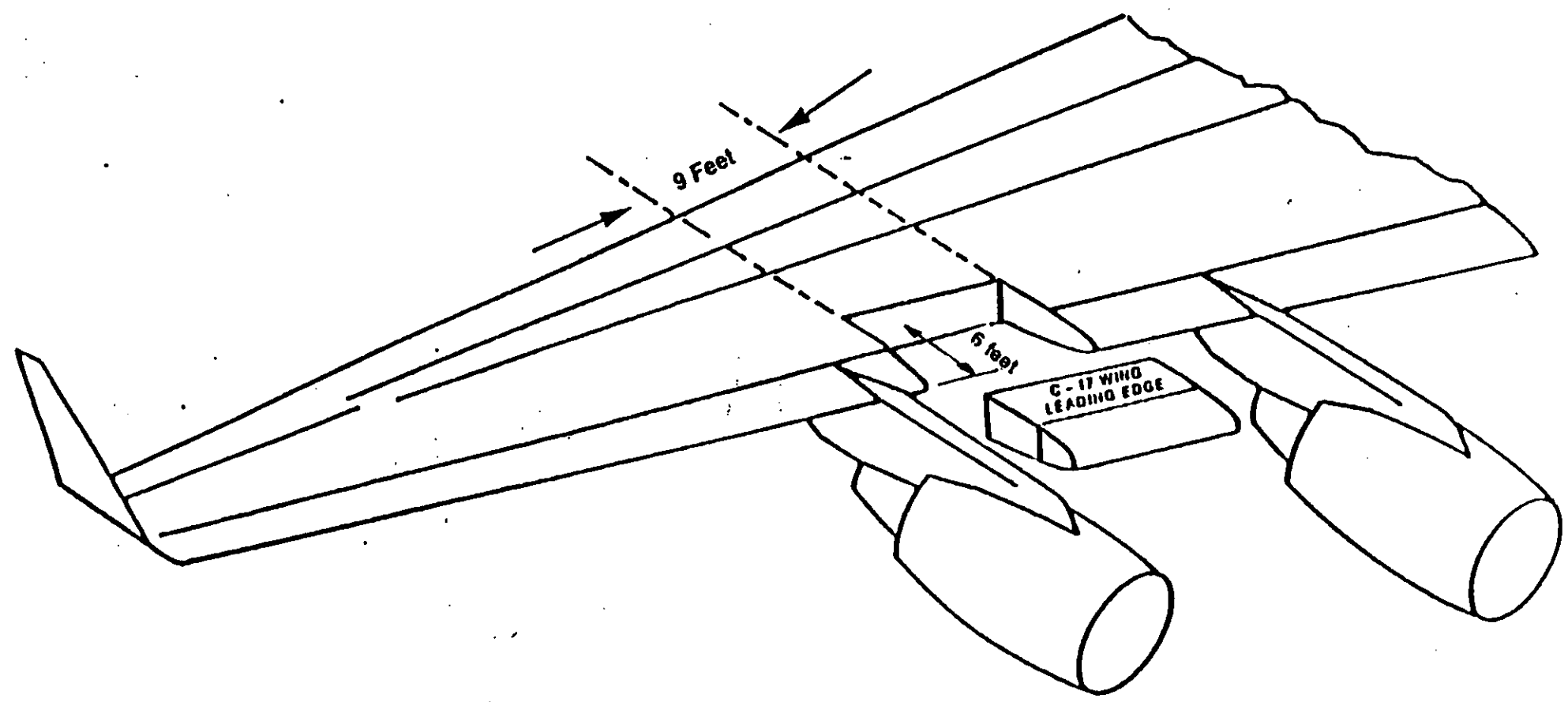

# **ASSESSMENT OF AIR FORCE PROPOSED BALLISTIC TESTS**

- **LIMITED TO 12.7MM API — DESIGN THREAT IS LOW END OF THREAT SPECTRUM**
- **LIMITED TO DRY BAY FIRE ISSUE IN A PORTION OF WING LEADING EDGE —THERE ARE OTHER IMPORTANT ISSUES TO ADDRESS AND OTHER DRY BAYS IN THE WING**
- **TEST ARTICLE IS NOT A PRODUCTION ITEM — SOME RISK OF OBTAINING UNREPRESENTATIVE RESULTS**

# PLANNED AIR FORCE C-17A BALLISTIC VULNERABILITY TESTS

ISSUES		THREAT CLASSES			
		MAN-PORTABLE, OTHER IR SAMS	RF SAMS, AAM, ASM, BOMBS, ARTILLERY	AAA PROJECTILES, OTHER PROJECTILES (23MM API/HEI, 30MM HEI)	SMALL ARMS, AUTOMATIC WEAPONS (12.7MM API)
FUEL SYSTEM	DRY BAY FIRE				▨
	ULLAGE				
	RAM INDUCED STRUCTURAL FAILURE				
PROPULSION	FIRE (PROPAGATION UP PYLON)				
	UNCONTAINED ENGINE FAILURE				
	ENGINE-FLAP SYNERGISM				

▨ = planned ballistic tests using Air Force proposed wing leading edge test article.

# **ASSESSMENT OF THE AIR FORCE PLANNED BALLISTIC TESTS**

## **CONCLUSIONS**

- **THE AIR FORCE PROPOSED WING LEADING EDGE TEST ARTICLE IS ONLY ADEQUATE FOR:**
  - **Testing with one threat, 12.7MM API — (not adequate for larger threats such as 23MM API or HEI)**
  - **Assessing only one damage mechanism, dry bay fires**
  - **And then only under certain conditions**
  
- **THERE IS CONSIDERABLE RISK ASSOCIATED WITH THESE LIMITED TESTS BECAUSE:**
  - **Other expected threats will not be addressed**
  - **Other important damage mechanisms will not be addressed**
  - **The test article not representative of a production wing for many shot lines**
  - **Results based on test article may be misleading**

# **PRIORITY ISSUES THAT WOULD REQUIRE TESTING TO REDUCE RISK**

- **RAM-INDUCED WING STRUCTURAL FAILURE**
  - Can threat impact on a C-17A fuel cell cause sufficient hydrodynamic ram damage to cause the loss of a wing?
- **DRY BAY FIRE**
  - Can an impact on any of the dry bays in the wing leading edge or trailing edge cause a sustained fire?
- **PYLON FIRE INITIATION/PROPAGATION**
  - Can a threat impact on a pylon cause a fire, defeat the fire barriers and lead to a sustained fire in the wing?



# PRIORITY ISSUE - THREAT MATRIX

ISSUES		THREAT CLASSES					
		MAN-PORTABLE, OTHER IR SAMS	RF SAMS, AAM, ASM, BOMBS, ARTILLERY	AAA PROJECTILES, OTHER PROJECTILES			SMALL ARMS, AUTOMATIC WEAPONS (12.7MM API)
				23MM API	23MM HEI	30MM HEI	
FUEL SYSTEM	DRY BAY FIRE						
	ULLAGE						
	RAM INDUCED STRUCTURAL FAILURE						
PROPULSION	FIRE (PROPAGATION UP PYLON)						
	UNCONTAINED ENGINE FAILURE						
	ENGINE-FLAP SYNERGISM						

 = planned ballistic tests using Air Force proposed wing leading edge test article.

 = ODLFT proposed additional ballistic tests.

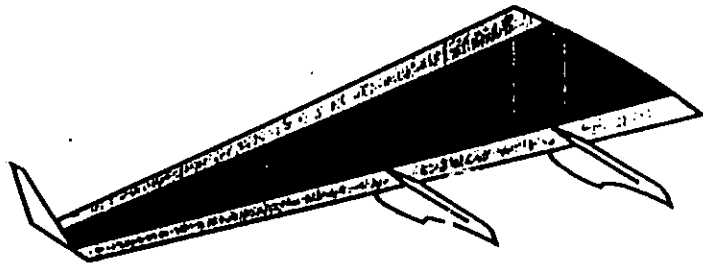

**OPTION 1 Complete Production Wing  
With Pylons Without Engines**

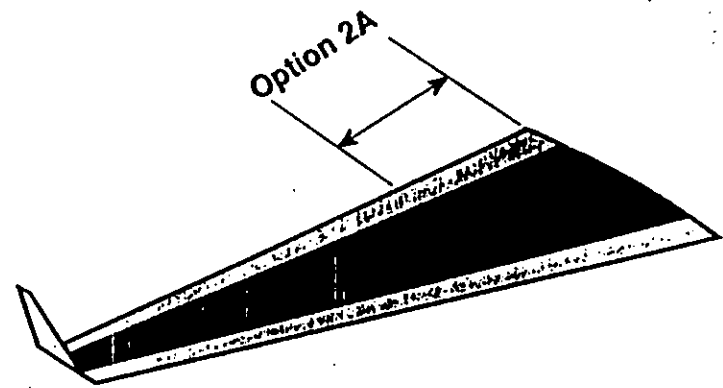

**OPTION 2 Complete Production Wing  
Without Pylons and Engines**

**OPTION 2A Section of Production Wing  
with Inboard Fuel Tank  
and Resident Systems**

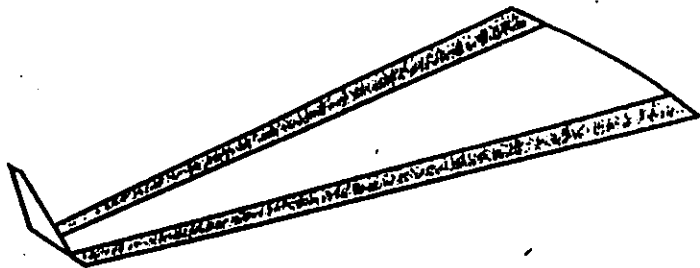

**OPTION 3 Wing From Static Test Article  
With Systems Added to Drybays**

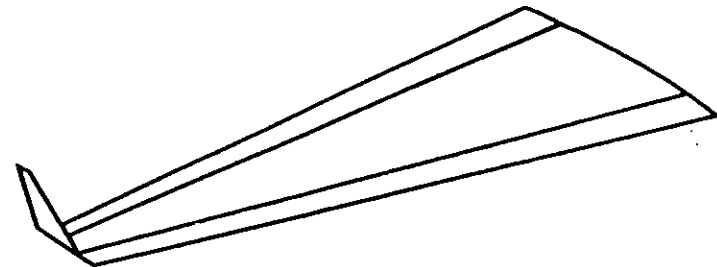

**OPTION 4 Wing From Static Test Article  
Without Systems Added**

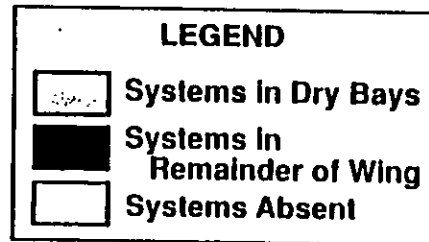

## ISSUES ADDRESSED FOR EACH TEST OPTION

ISSUES ADDRESSED	OPTIONS			
	1. Production Wing With Pylons	2. Production Wing Without Pylons  2A. Section* of Production Wing Without Pylons.	3. Static Test Article Wing With Systems Added to Dry Bay	4. Static Test Article Wing
1. RAM Induced wing structural failure	X	X	X	X
2. Dry bay fire	X	X	X	
3. Pylon fire Initiation/propagation	X			

\*Limited to inboard tank, adjacent dry bays, and resident systems.

**ADDITIONAL C-17A VULNERABILITY TEST OPTIONS  
BENEFIT – COSTS**

OPTION	BENEFITS	COSTS* (FY 93 \$M)	
		TEST ARTICLE	TEST CONDUCT
1. PRODUCTION WING WITH PYLONS	ADDRESSES ISSUES: RAM Induced wing failure, dry bay fire, and pylon fire Initiation/propagation  WITH HIGH FIDELITY	37.5	6.2
2. PRODUCTION WING WITHOUT PYLONS	ADDRESSES ISSUES: RAM Induced wing failure and dry bay fire  WITH HIGH FIDELITY	32.8	5.4
2A. SECTION OF PRODUCTION WING WITH INBOARD FUEL TANK AND RESIDENT SYSTEMS	ADDRESSES ISSUES: RAM Induced wing failure and dry bay fire  WITH HIGH FIDELITY BUT LIMITED TO INBOARD TANK AND ITS ADJACENT DRY BAYS; WILL NOT INCLUDE VARIATION IN TANKS AND DRY BAYS IN REMAINDER OF WING	30.8	3.8
3. WING FROM STATIC TEST ARTICLE WITH SYSTEMS ADDED TO DRY BAYS	ADDRESSES ISSUES: RAM Induced wing failure and dry bay fire  BUT THERE ARE RISKS TEST ARTICLE WILL BE: - Irreparably damaged from static tests  - Not fully production representative	13.3	5.4
4. WING FROM STATIC TEST ARTICLE WITHOUT SYSTEMS	ADDRESSES ISSUE: RAM Induced wing failure  BUT THERE ARE RISKS TEST ARTICLE WILL BE: - Irreparably damaged from static tests  - Not fully production representative	4.0	3.4

\*Rough order of magnitude cost estimates include spares and contractor support.

# THE FOUR PROPOSED OPTIONS WILL INCREMENTALLY REDUCE THE RISKS BY:

- ADDRESSING ADDITIONAL THREATS, E.G.,
  - 12.7MM HEI
  - 14.5MM API/HEI
  - 20MM API/HEI
  - 23MM API/HEI
  - 30MM HEI
  - Man-portable SAMs
  
- ADDRESSING ADDITIONAL VULNERABILITY DAMAGE MECHANISMS
  - Hydrodynamic ram induced structural failure
  - Realistic dry bay fires
  - Pylon fire initiation and propagation
  
- EMPLOYING A PRODUCTION-REPRESENTATIVE TEST ARTICLE
  - To address the above threats and issues
  - To verify the results for the planned 12.7MM API wing leading edge tests and extend them to other dry bays

# **XAMPLES OF POTENTIAL FIXES IF PROPOSED VULNERABILITY TESTS UNCOVER PROBLEMS**

- **RAM-INDUCED WING STRUCTURAL FAILURE**
  - Change aircraft automatic fuel management system
  - Depending on the mode of failure, past experience demonstrates that simple, inexpensive design changes can sometimes reduce problem, e.g.,
    - Change in type of fasteners used
    - Add liner to vulnerable portion of spar
- **DRY BAY FIRE**
  - Install passive and/or active fire suppression system
- **PYLON FIRE INITIATION/PROPAGATION**
  - Install passive and/or active fire suppression system in pylon
  - Relocate or increase shielding of fuel lines in pylon
  - Install self-sealing fuel lines in pylon area

**QUESTION: IF PROPOSED TESTS UNCOVER VULNERABILITY PROBLEM, ARE THERE COST-EFFECTIVE SOLUTIONS AVAILABLE?**

<b>POTENTIAL VULNERABILITY</b>	<b>EXAMPLE SOLUTION</b>
<b>HYDRODYNAMIC RAM INDUCED STRUCTURAL DAMAGE TO WING</b>	<ul style="list-style-type: none"><li>• <b>FUEL MANAGEMENT PROGRAM FOR COMBAT MISSIONS</b></li><li>• <b>RAM ATTENUATION LINER</b></li></ul>
<b>DRY BAY FIRES</b>	<ul style="list-style-type: none"><li>• <b>AUTOMATIC FIRE EXTINGUISHERS</b></li></ul>
<b>PYLON FIRES</b>	<ul style="list-style-type: none"><li>• <b>AUTOMATIC FIRE EXTINGUISHERS</b></li></ul>

# C-17A WIN FUEL TANKS

FIGURES ARE FOR 50% AIRCRAFT FUEL CAPACITY

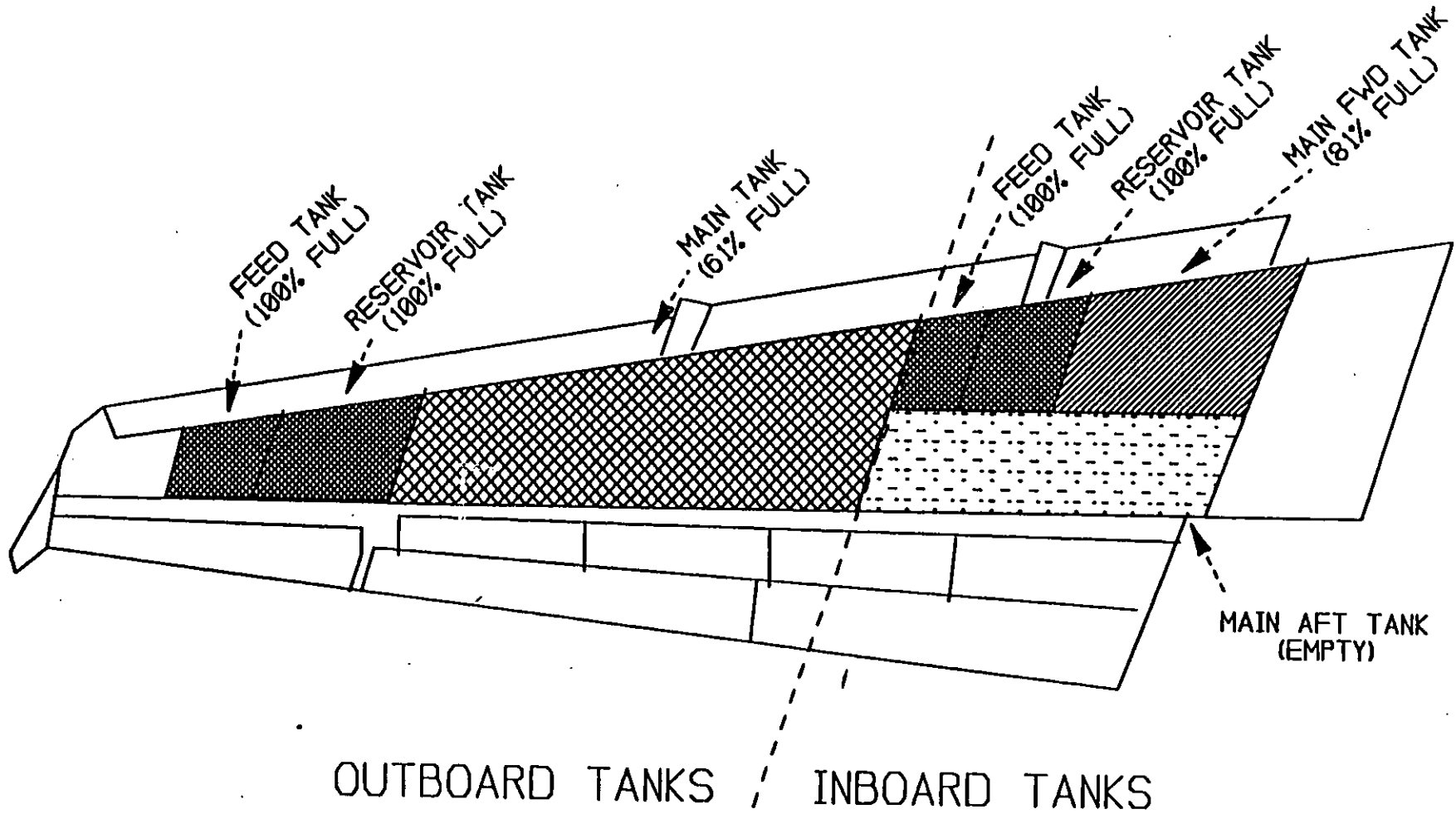



# **FUEL MANAGEMENT PROGRAM FOR COMBAT MISSIONS**

- **DAMAGE FROM HYDRODYNAMIC RAM EFFECT DECREASES WITH DECREASING FUEL LEVEL IN IMPACTED TANK**
- **MODIFY FUEL MANAGEMENT SYSTEM TO FACILITATE TWO PROGRAMS**
  - **Benign mission program**
  - **Combat mission program**
- **BENIGN MISSION PROGRAM WOULD SEQUENCE FUEL TANK LEVELS TO MAINTAIN C.G. FOR MAXIMUM FUEL EFFICIENCY (SOME TANKS REMAIN FULL WHEN OTHERS ARE EMPTY)**
- **COMBAT FUEL MANAGEMENT PROGRAM WOULD BALANCE FUEL LEVELS TO AVOID HAVING SOME TANKS NEAR FULL**
- **MODIFICATION REQUIRES ADDITION OF VALVES AND SWITCH AND CHANGES IN SOFTWARE**

# RAM ATTENUATION LINER APPLICATION

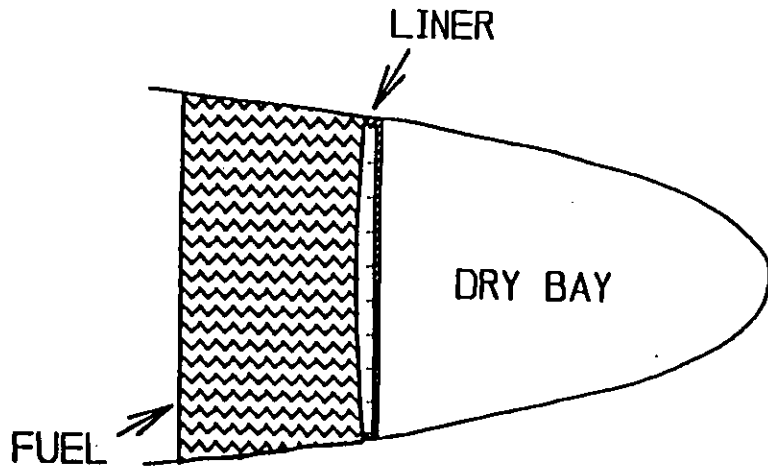

DEFLATED TO ALLOW LARGER INITIAL FUEL LOAD

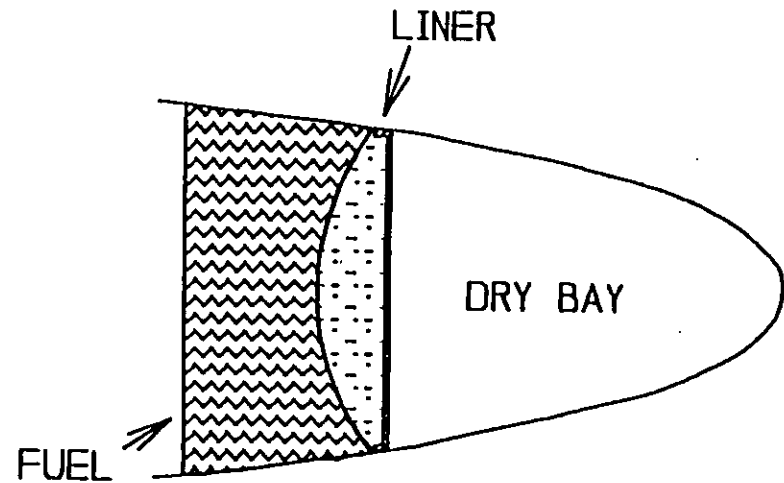

INFLATED LATER IN MISSION WITH NITROGEN ENRICHED AIR FROM OBIGGS SYSTEM

# SECTION OF RAM / TENUATION LINER



## **RAM ATTENUATION LINER**

- **INFLATABLE BLADDERS ARE ATTACHED TO THE SPAR IN THE FUEL TANKS THAT ARE VULNERABLE TO HYDRODYNAMIC RAM STRUCTURAL DAMAGE**
- **CAN BE DEFLATED AT START OF MISSION AND INFLATED AS FUEL IS DRAWN OFF DURING FLIGHT**
- **COULD BE INFLATED WITH NITROGEN ENRICHED AIR FROM ONBOARD INERT GAS GENERATING SYSTEM (OBIGGS) TO ALSO REDUCE CHANCES OF FIRE**
- **SYSTEM INCLUDES BLADDERS, VALVES, REGULATORS AND CONTROLS**

# RAM ATTENUATION LINER ON FRONT SPAR IN ALL FUEL TANKS

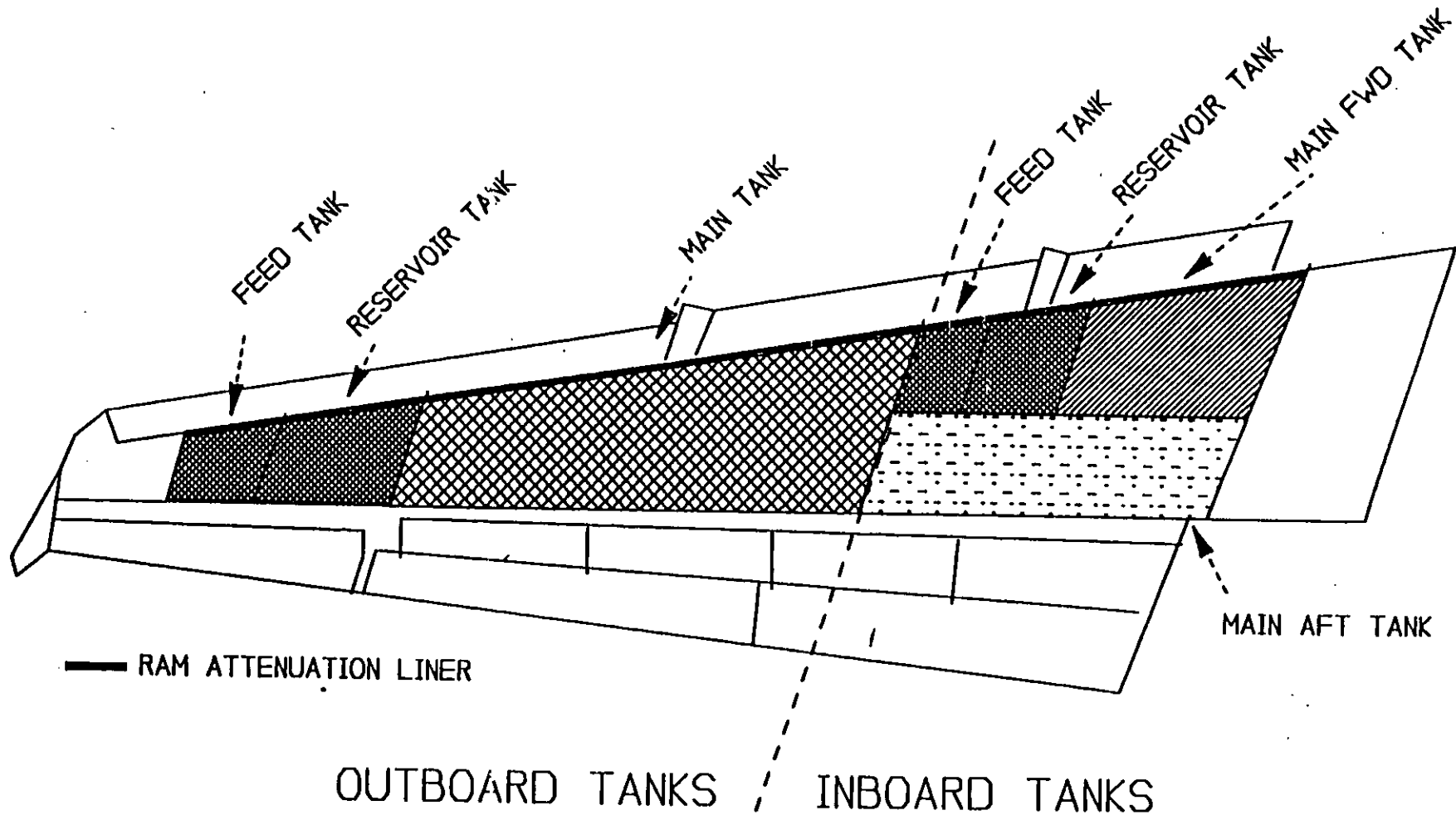

# FUEL MANAGEMENT SYSTEM AND RAM ATTENUATION LINER FOR FEED AND RESERVOIR TANKS

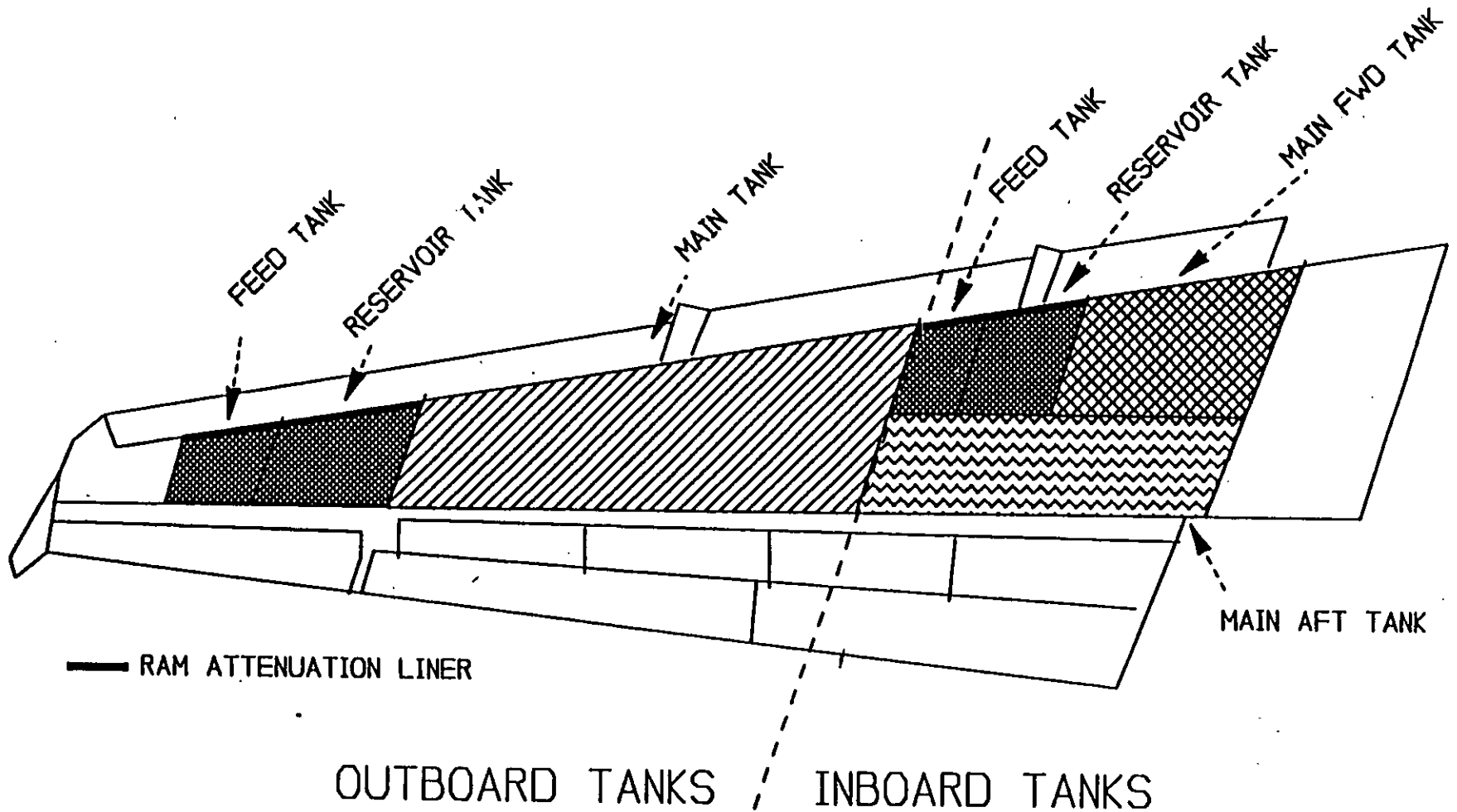

# RAM ATTENUATION LINER

BENEFITS	COSTS*
<ul style="list-style-type: none"><li>• REDUCE HYDRODYNAMIC RAM INDUCED STRUCTURAL DAMAGE TO WINGS</li><li>• (SECONDARY) REDUCE RISK OF FIRE</li></ul>	<b>FRONT SPAR — ALL TANKS</b> <ul style="list-style-type: none"><li>• ADDITIONAL WEIGHT ~130 POUNDS</li><li>• REDUCTION IN FUEL CAPACITY ~190 POUNDS</li><li>• ROM LIFE CYCLE COST ESTIMATES<ul style="list-style-type: none"><li>- \$226K per aircraft</li><li>- \$27.1M for 120 aircraft fleet</li></ul></li></ul>
	<b>FRONT SPAR — FEED AND RESERVOIR TANKS</b> <ul style="list-style-type: none"><li>• ADDITIONAL WEIGHT ~40 POUNDS</li><li>• REDUCTION IN FUEL CAPACITY ~60 POUNDS</li><li>• ROM LIFE CYCLE COST ESTIMATES<ul style="list-style-type: none"><li>- \$81K per aircraft</li><li>- \$9.8M for 120 aircraft fleet</li></ul></li></ul>

\*Assumes installation during aircraft production for all 120 aircraft.

## **AUTOMATIC FIRE EXTINGUISHERS**

- **OPTICAL SENSOR DETECTS AND DISCRIMINATES FIRES FROM OTHER RADIATION SOURCES BASED ON WAVE LENGTH**
- **EXTINGUISHER DISCHARGES AGENT IN MILLISECONDS**
- **OFF-THE-SHELF SYSTEMS AVAILABLE; PROVEN IN ENGINE NACELLE FIRE PROTECTION AND IN SEVERAL VEHICLES**
- **SYSTEM INCLUDES DETECTOR AND EXTINGUISHER IN EACH DRY BAY/PYLON, AND CONTROL CIRCUIT WITH BUILT IN TEST**



# AUTOMATIC FIRE EXTINGUISHERS

<b>BENEFITS</b>	<b>COSTS*</b>
<ul style="list-style-type: none"> <li>• <b>EFFECTIVE ONE SHOT FIRE SUPPRESSION</b></li>   <li>• <b>EXTREMELY FAST (MILLISECONDS)</b></li>   <li>• <b>PEACETIME AS WELL AS COMBAT FIRE PROTECTION</b></li>   <li>• <b>LOW MAINTENANCE</b></li> </ul>	<p><b>DRY BAY APPLICATION</b></p> <ul style="list-style-type: none"> <li>• <b>TOTAL SYSTEM WEIGHT FOR 40 WING LEADING EDGE DRY BAYS PER AIRCRAFT ~150 POUNDS</b></li>   <li>• <b>LIFE CYCLE COSTS FOR WING LEADING EDGE</b> <ul style="list-style-type: none"> <li>- \$260K per aircraft</li> <li>- \$30.7M for 120 aircraft fleet</li> </ul> </li> </ul> <hr/> <p><b>PYLON APPLICATION</b></p> <ul style="list-style-type: none"> <li>• <b>TOTAL SYSTEM WEIGHT FOR ALL 4 PYLONS ~15 POUNDS</b></li>   <li>• <b>LIFE CYCLE COSTS FOR PYLON APPLICATION</b> <ul style="list-style-type: none"> <li>- \$21K per aircraft</li> <li>- \$2.5M for 120 aircraft fleet</li> </ul> </li> </ul>

\*Assumes installation during aircraft production for all 120 aircraft.

# EXAMPLE VULNERABILITY REDUCTION SYSTEMS COST SUMMARY

POTENTIAL VULNERABILITY	EXAMPLE SOLUTION	SYSTEM WEIGHT ESTIMATES AND (CHANGE IN FUEL CAPACITY)	LIFE CYCLE COSTS* FOR 120 AIRCRAFT FLEET (FY 93 \$M)
HYDRODYNAMIC RAM INDUCED STRUCTURAL DAMAGE TO WING	FUEL MANAGEMENT PROGRAM FOR COMBAT MISSIONS	60 LBS.	\$16.7
	RAM ATTENUATION LINER FOR FRONT SPAR IN ALL TANKS	130 LBS. (-190 LBS. FUEL)	\$27.1
	FUEL MANAGEMENT PROGRAM FOR COMBAT MISSIONS + RAM ATTENUATION LINER IN FEED AND RESERVOIR TANKS	100 LBS. (-60 LBS. FUEL)	\$26.5
DRY BAY FIRES	AUTOMATIC FIRE EXTINGUISHERS	150 LBS.	\$30.7
PYLON FIRES	AUTOMATIC FIRE EXTINGUISHERS	15 LBS.	\$2.5

\*Rough order of magnitude cost estimates to equip all 120 aircraft assuming installation at production.

## **CONCLUSIONS**

- **LIMITING VULNERABILITY TESTING TO THAT PLANNED BY THE AIR FORCE INCURS UNACCEPTABLE RISKS**
- **ANY ONE OF THE PROPOSED TEST OPTIONS WOULD COST LESS THAN 1/10 OF 1 PERCENT OF THE C-17 PROCUREMENT COST**
- **IF THE TESTING VERIFIES SUSPECTED VULNERABILITIES, THERE ARE COST-EFFECTIVE MEANS AVAILABLE TO REDUCE THE VULNERABILITIES WITHOUT MAJOR STRUCTURAL CHANGES TO THE AIRCRAFT**
- **OPTION 3 (STATIC TEST ARTICLE WITH SYSTEMS ADDED TO DRY BAYS) WILL ADDRESS THE HIGHEST PRIORITY ISSUES FOR A REASONABLE COST**

# **ASSESSMENT OF THE C-17A VULNERABILITY PROGRAM**

## **RECOMMENDATIONS**

- **SELECT OPTION 3 — STATIC TEST ARTICLE WITH SYSTEMS ADDED TO DRY BAYS (OPTION 3 ADDRESSES HIGHEST PRIORITY ISSUES FOR REASONABLE COST)**
- **AIR FORCE INCLUDE APPROPRIATE VULNERABILITY REDUCTION SYSTEMS IN THE TESTS WITH OPTION 3**



OFFICE OF THE DIRECTOR OF  
DEFENSE RESEARCH AND ENGINEERING

WASHINGTON, DC 20301-3030

27 MAR 1992

*leaf 4/3/92*

MEMORANDUM FOR DIRECTOR, TEST AND EVALUATION (AF/TE)  
THROUGH: DEPUTY DIRECTOR, DEFENSE RESEARCH  
AND ENGINEERING (TEST AND EVALUATION)

*Adby 30 MAR*

SUBJECT: C-17 Vulnerability Testing

The C-17, although not a Live Fire Test system according to the OSD General Counsel, will undergo vulnerability testing. The details of that vulnerability testing are still under discussion but our office will have some oversight and reporting responsibility. Hence, we will continue to be involved with all vulnerability testing and analysis.

We request that you continue to invite us to attend all C-17 vulnerability tests and other significant events.

James F. O'Bryon  
Director  
Live Fire Testing

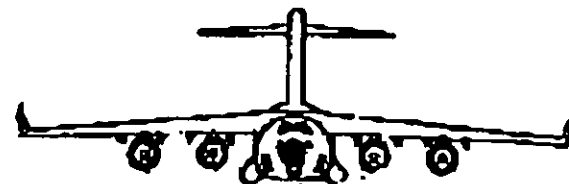

# **C-17A**

# **VULNERABILITY PROGRAM**

**PRESENTED TO: MAJ GEN FRANKLIN**

**MR TED LYNCH**  
**C-17 TECHNICAL DIRECTOR**  
**23 MARCH 1992**



# **OUTLINE**

**APPROACH**

**DESIGN REQUIREMENTS**

**ASSESSMENT**

**TESTING**

**POTENTIAL SURVIVABILITY ENHANCEMENTS  
AND STUDIES**

**SUMMARY**



# APPROACH





# **PROGRAM APPROACH**

- **VULNERABILITY POSTURE ESTABLISHED THROUGH APPLICATION OF PROVEN DESIGN PRACTICES**
  - **REDUNDANCY**
  - **SEPARATION**
  - **FIRE PROTECTION**
- **VULNERABILITY TESTING AND ANALYSIS IS INTEGRAL PART OF C-17 PROCESS**

**MAXIMUM USE OF EXISTING INFORMATION**



# **VULNERABILITY DESIGN**

- **SYSTEMS ENGINEERING BASED PROGRAM**
  - **DESIGN CHANGES DERIVED FROM FAILURE MODE EFFECTS AND CRITICALITY ANALYSIS, DAMAGE MODE AND EFFECTS ANALYSIS, AS WELL AS VULNERABILITY ANALYSIS**
  - **DEVELOPMENTAL TESTING AIMED AT VALIDATION OF ANALYSIS BY SUPPLEMENTING EXISTING DATA**



# **VULNERABILITY DESIGN**

## **(CONT'D)**

- **COMPONENT SELECTION CRITERIA**
  - **INVULNERABLE ITEMS BASED ON ANALYSIS LACKING DATA BASE SUPPORT**
    - **FLAP HINGE**
  - **ITEMS WHICH CONTRIBUTE SIGNIFICANTLY TO VULNERABLE AREA WITH INSUFFICIENT DATA**
    - **WING LEADING EDGE, OBIGGS BOTTLE, ESCAPE ACCUMULATOR**
  - **BASIC MATERIAL BALLISTIC DATA BASE INADEQUATE**
    - **UPPER WING SKIN**

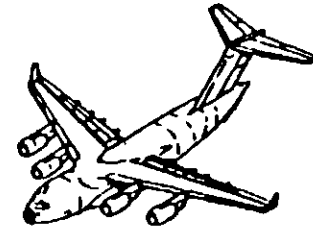

# **VULNERABILITY DESIGN REQUIREMENTS**



# SYSTEM PROTECTION REQUIREMENTS

DESIGN FOR HIGHEST PRACTICAL LEVEL OF PROTECTION AGAINST 12.7 API

*System Requirement*

## VERIFICATION

### ANALYSIS

*Models*  
*Primary*  
*Greater level of threat assessed*

- USE JTCG / AS APPROVED METHODOLOGY AND ASSUMPTIONS
- ANALYSIS COMPLETE EXCEPT FOR FLAP TANDEM CONTROL VALVE AND HEI STRUCTURAL ASSESSMENT - SCHEDULED COMPLETION NOV 92
- RESULTS TO DATE REVIEWED AND APPROVED BY SPO ENGINEERING, ASD SYSTEMS ANALYSIS, AND FLIGHT DYNAMICS LABORATORY



# PROPULSION SYSTEM REQUIREMENTS

- SEPARATE FEED LINES AND CONTROLS - EACH ENGINE
- SINGLE HIT DAMAGE TO MOUNTING WILL NOT CAUSE LOSS OF AIRCRAFT CONTROL
- ENGINE BLADE CONTAINMENT TO MEET FAA CERTIFICATION REQUIREMENTS
- CRITICAL ENGINE CONTROL COMPONENTS SEPARATED

*Paraphrased  
from  
AW Spec*

## VERIFICATION

- ANALYSIS - SPO REVIEW VERIFIED THAT SINGLE HIT WILL NOT RESULT IN LOSS OF AIRCRAFT CONTROL
- TEST - ENGINE FAA CERTIFIED IN 1983



# FUEL SYSTEM REQUIREMENTS

*Add  
Electronic  
Eng Controls  
Line Separation  
bltac*

- NO SINGLE HIT SHALL CAUSE STARVATION OF MORE THAN ONE ENGINE
- FUEL MANAGEMENT CONTROLS TO PREVENT FEEDING DAMAGED TANKS
- FULL-TIME AUTOMATIC FUEL TANK AND VENT LINE INERTING
  - MAINTAIN OXYGEN CONTENT BELOW 9%; FUEL TANK FIRE AND EXPLOSIONS CAN BE PREVENTED FOR THREATS UP TO 23 mm HEI, BASED ON ANALYSIS AND PREVIOUS TEST DATA (REFERENCE AFWAL-TR-87-2024, FIGHTER AIRCRAFT OBIGGS STUDY DATED JUN 87)

*150 gal tank  
231 50MM tests after simulated mission w/ sloshing*

## VERIFICATION

*Aspie Schub  
on C-5A*

*OBIGGS*

- GROUND TESTS IN <sup>V</sup>SIMULATOR - IN PROGRESS, COMPLETION DATE - DEC 92 *ensure nitrogen in → O<sub>2</sub> content below 9% one wing full size at LB*
- FLIGHT TESTS TO VERIFY SYSTEM OPERATION - COMPLETION DATE - MAY 93
- OBIGGS BOTTLES TESTED AGAINST .50 CAL ROUNDS IN DEVELOPMENT TEST, REDESIGNED BOTTLE PASSED TEST - MAR 91



# FUEL MANAGEMENT SYSTEMS

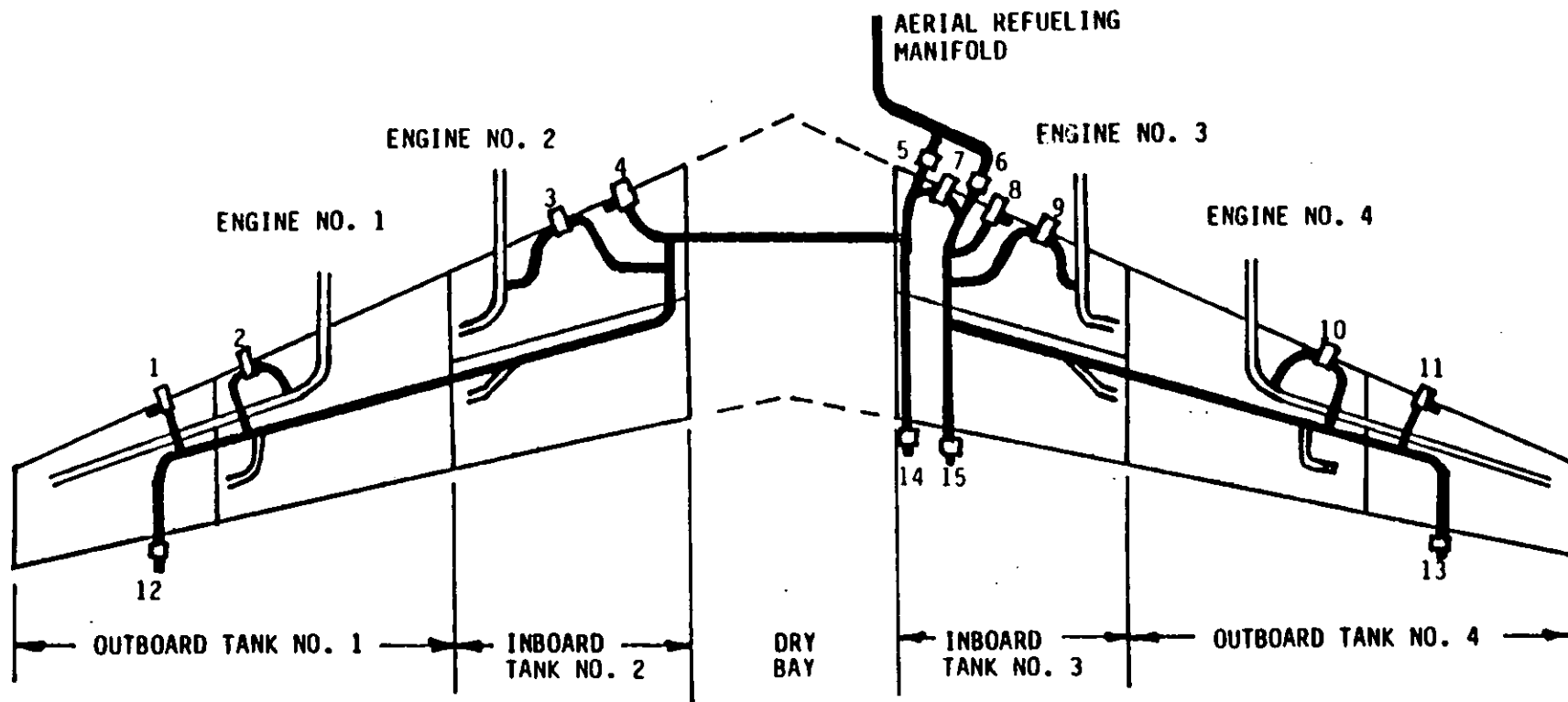

VALVE NO.	FUNCTION
1	TANK NO. 1 FILL
2	TANK NO. 1 CROSS-FEED
3	TANK NO. 2 CROSS-FEED
4	TANK NO. 2 FILL
5	LEFT WING AR ISOLATION
6	RIGHT WING AR ISOLATION
7	CENTER SEPARATION

VALVE NO.	FUNCTION
8	TANK NO. 3 FILL
9	TANK NO. 3 CROSS-FEED
10	TANK NO. 4 CROSS-FEED
11	TANK NO. 4 FILL
12	LEFT WING DUMP
13	RIGHT WING DUMP
14	GROUND REFUEL ISOLATION
15	GROUND REFUEL ISOLATION





# HYDRAULIC SYSTEM REQUIREMENTS

- NO SINGLE HIT OF FLIGHT CRITICAL COMPONENTS WILL CAUSE FLYING QUALITIES TO DEGRADE BELOW LEVEL III
- ACCUMULATORS WILL NOT FRAGMENT WHEN HIT BY DESIGN THREAT

## VERIFICATION

- INSPECTION - SPO VERIFIED EXISTING COMPONENTS PREVIOUSLY PASSED GUN FIRE TEST *at 12.7MM level / some qualified w/ tumbling .50 cal*
- ANALYSIS - SPO REVIEWED FAILURE MODE AND FLYING QUALITIES ANALYSES AND CONCURRED THAT REQUIREMENT IS BEING MET
- TEST - SPO VERIFIED THAT NEW ESCAPE SYSTEM ACCUMULATOR PASSED ITS TEST ON 2 FEB 92

↓ *tumbling .50 cal test*

# FOUR-SYSTEM REDUNDANCY

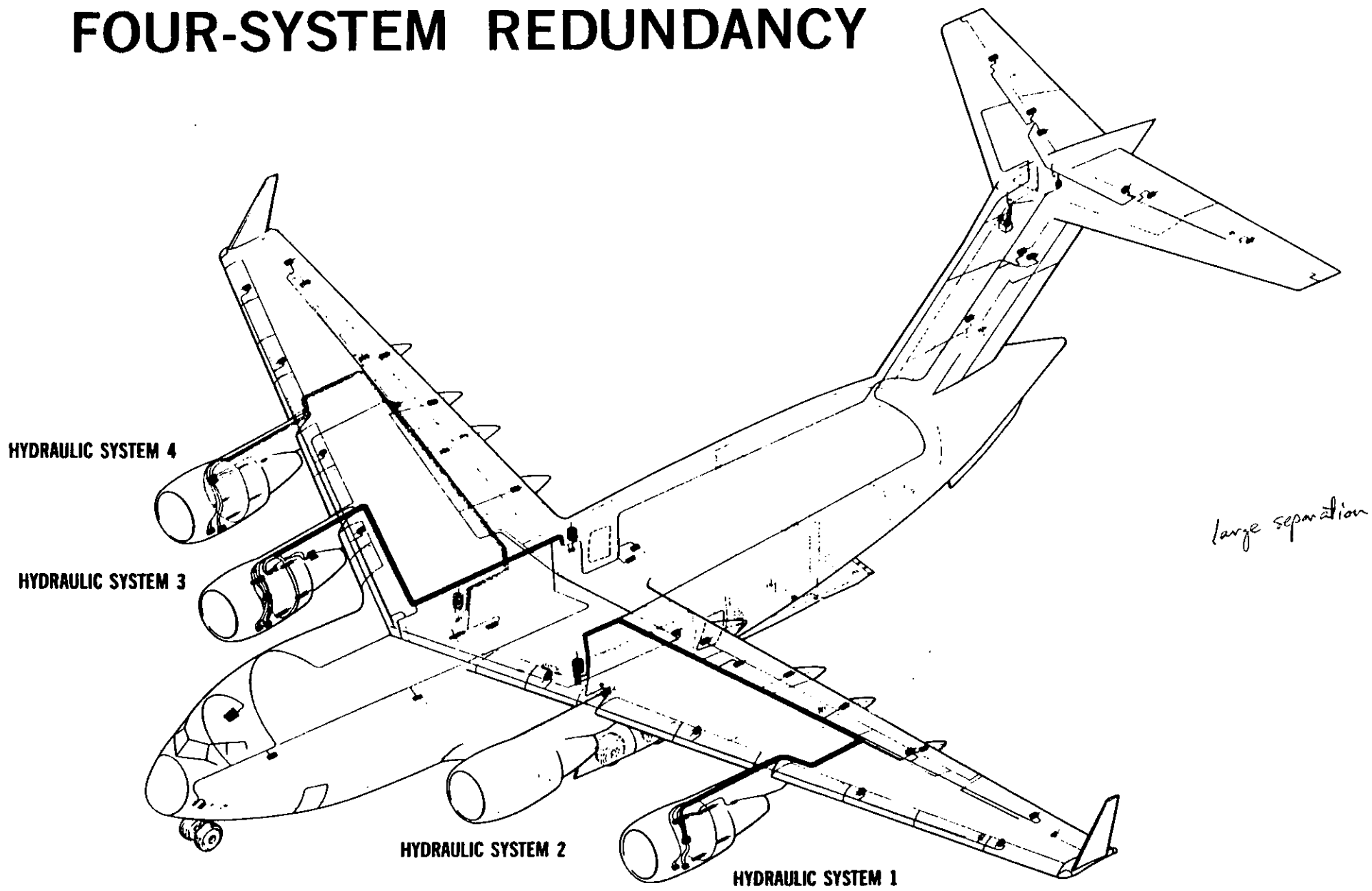



# OXYGEN SYSTEM REQUIREMENTS

- ISOLATE CONTAINERS FROM EACH OTHER AND FLAMMABLE FLUIDS
- DESIGN CONTAINERS TO PREVENT SHATTERING PER MIL-C-25666

## VERIFICATION

**ANALYSIS** - SPO REVIEW FOUND ONE TROOP CONTAINER IN HAZARDOUS LOCATION; CONTAINER RELOCATED FROM WHEELWELL POD TO LEFT SIDE OF AIRCRAFT NOSE

**TEST** - CONTAINERS PREVIOUSLY GUNFIRE TESTED WITH .50 CAL ROUNDS FOR OTHER PROGRAMS

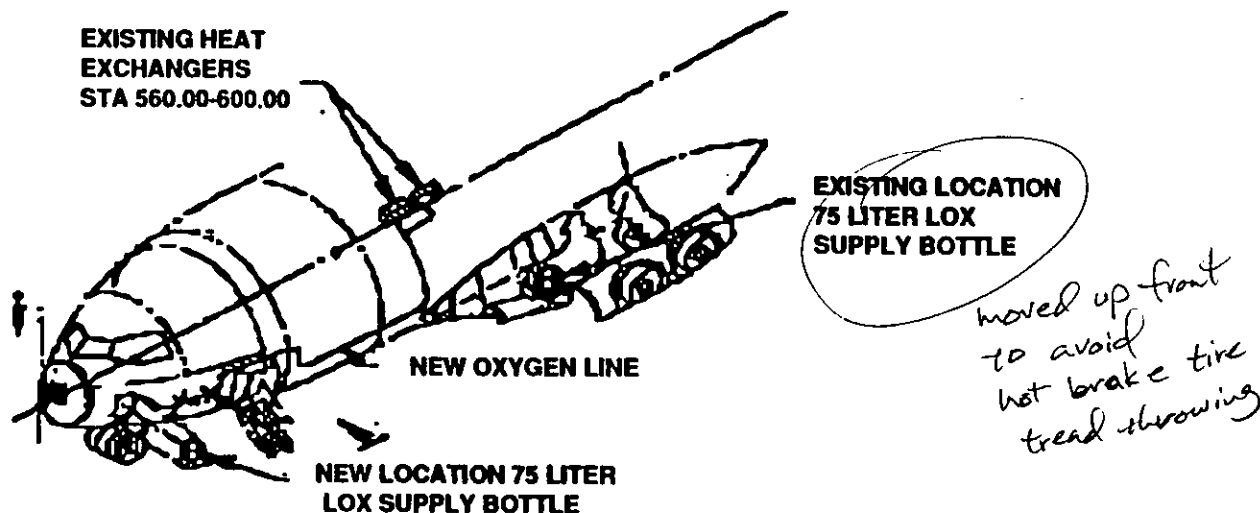



# CREW PROTECTION REQUIREMENTS

- SPACE PROVISIONS PERSONNEL ARMOR IN FLIGHT DECK AND LOADMASTER STATION

## VERIFICATION

- SPACE AND STRENGTH PROVISIONS BASED ON DAC PRELIMINARY DESIGN - SPO REVIEWED AND APPROVED
- ARMOR CLIP DESIGN TESTED WITH ARMOR; CLIPS ABSORB ~~SIGNIFICANT~~ BALLISTIC IMPACT - TEST COMPLETED NOV 88

↑  
12.7 MM



# CREW BALLISTIC PROTECTION PROVISIONS

## SPACE PROVISIONS

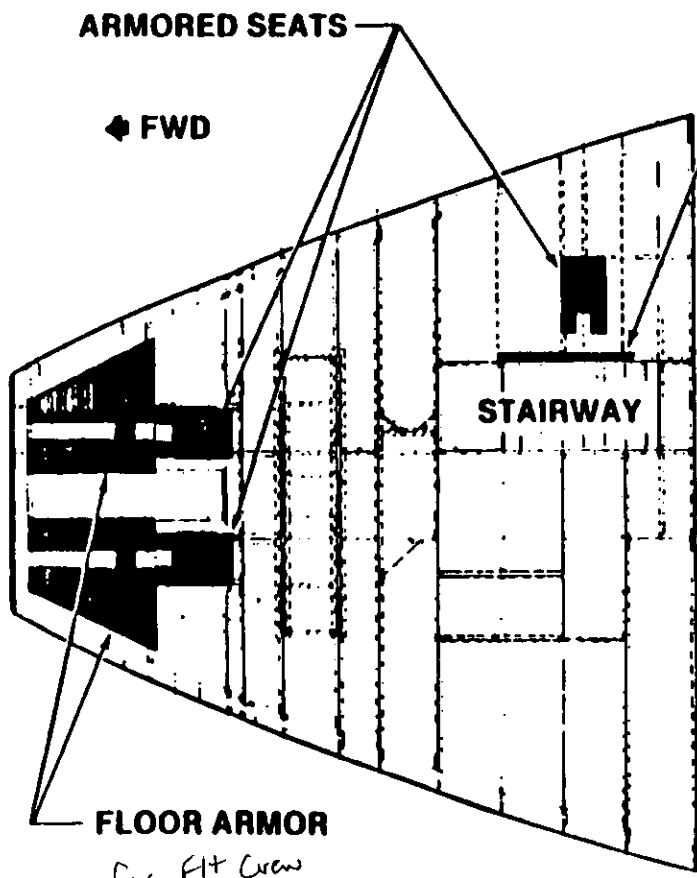

PLAN VIEW

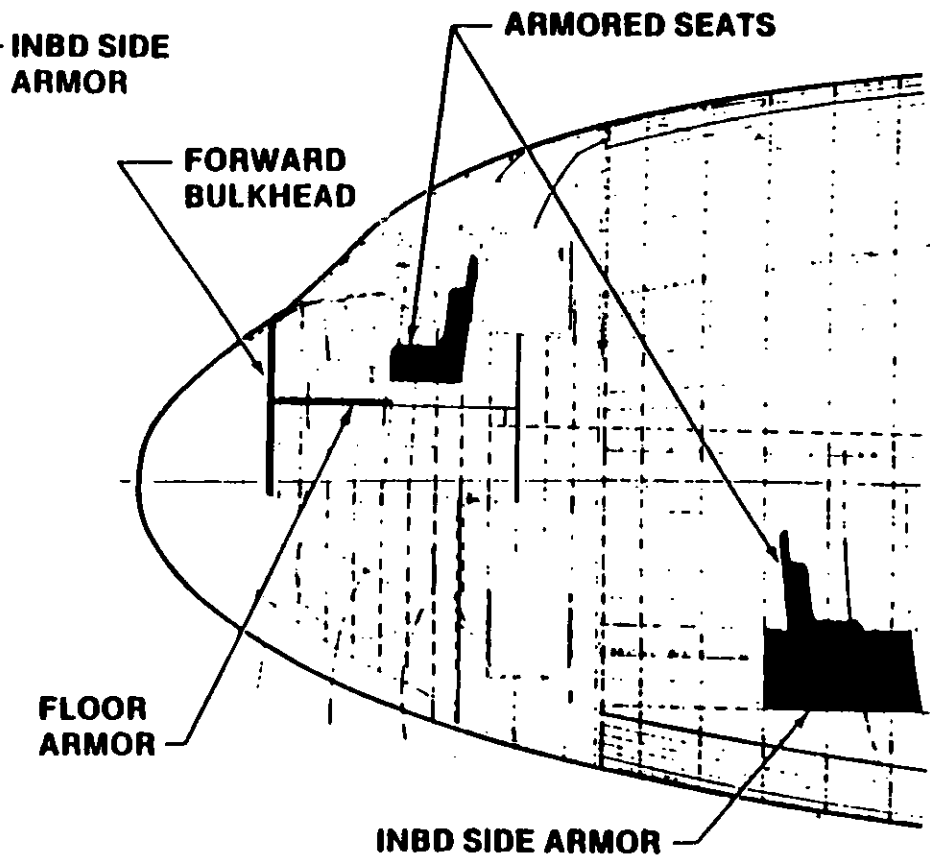

SIDE VIEW



# FLIGHT CONTROL SYSTEM REQUIREMENTS

*Location of Major FCS components*

**ESSENTIAL AND FLIGHT PHASE ESSENTIAL FLIGHT CONTROL SYSTEMS WILL NOT GO BELOW OPERATIONAL STATE III GIVEN A SINGLE HIT**

*Controlable "get home" capability*

## VERIFICATION

**ANALYSIS OF FAILURE MODES - COMPLETE EXCEPT FOR FLAP TANDEM CONTROL VALVE. DAC SCHEDULE 17 APR 92. SPO REVIEW IN 30 DAYS AFTER RECEIPT.**



# AIRFRAME & CONTROL SURFACE REQUIREMENT

- FLIGHT ESSENTIAL COMPONENTS SHALL SUPPORT LIMIT LOADS AFTER SINGLE HIT → *Not dependant on size of threat*
- COMPLETE LOSS OF CONTROL SURFACES OR PARTIAL SEPARATION DUE TO A SINGLE HIT WILL NOT CAUSE A CATASTROPHIC LOSS

## VERIFICATION

- ANALYSIS** - PRELIMINARY ANALYSIS REVIEWED BY SPO AND WAS FOUND SATISFACTORY; 23 HEI ANALYSIS CURRENTLY IN WORK AT DAC - RESULTS AVAILABLE NOV 92 → *normal update cycle*  
↳ *DAC workload*
- TEST**
- NEW UPPER WING SKIN MATERIAL TESTED AGAINST 12.7 mm API ROUNDS TO DETERMINE RESPONSE; MATERIAL PROVED ADEQUATE - 1989
  - FLAP HINGE GUNFIRE TESTED FOR DAMAGE TOLERANCE; LOADCARRYING CAPABILITY OF ONE LUG REDUCED; ANALYSIS INDICATES OTHER LUG SUFFICIENT TO CARRY LOAD



# C-17 FLAP & VANE

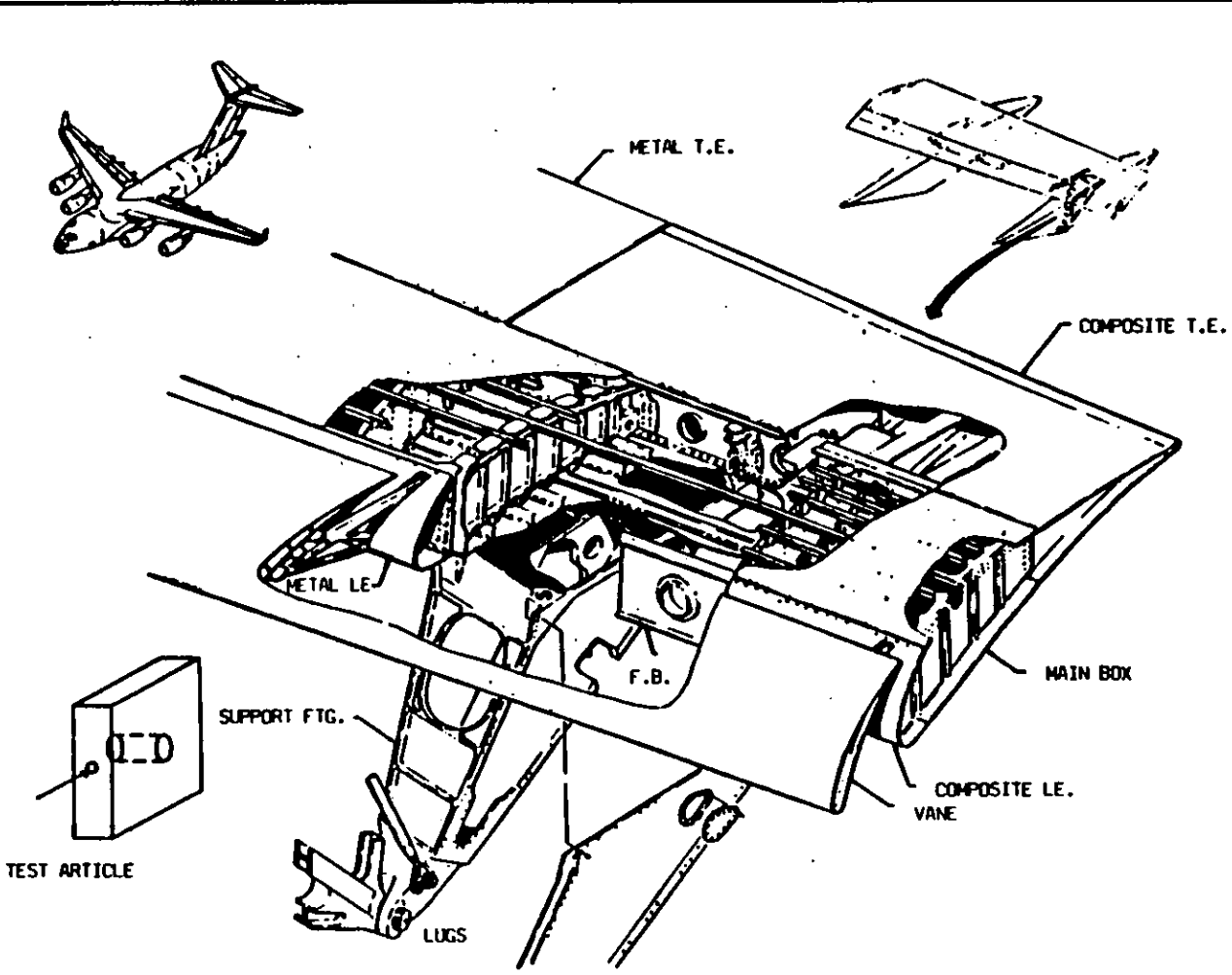

**FLAP HINGE**





# ELECTRICAL POWER SYSTEM REQUIREMENTS

- PREVENT COMPLETE ELECTRICAL FAILURE FROM A SINGLE HIT
- PROVIDE REDUNDANT OR BACKUP SYSTEMS FOR SUBSYSTEM OPERATION
- NO SINGLE GUNFIRE ELECTRICAL FAILURE WILL CAUSE LOSS OF FLIGHT ESSENTIAL EQUIPMENT

*60 → 90 Kva  
Generators*

*Failure Modes Effects*

## VERIFICATION

- ANALYSIS - SPO VERIFIED ANALYSIS THAT SHOWED NO SINGLE FAILURE RESULTS IN LOSS OF COMPLETE SYSTEM



# **AIR VEHICLE FIRE PROTECTION REQUIREMENTS**

- **FIRE DETECTION AND EXTINGUISHING SYSTEMS FOR ENGINES AND APU**
- **FLAMMABLE FLUID SHUT-OFF VALVES**
- **OVERHEAT DETECTION SYSTEM FOR PYLON, WING LEADING EDGE, AND FUSELAGE**
- **HANDHELD FIRE EXTINGUISHERS**
- **CARGO COMPARTMENT SMOKE DETECTORS**

## **VERIFICATION**

- **INSPECTION OF DRAWINGS - SPO VERIFIED EXISTENCE OF EQUIPMENT**
- **ANALYSIS - SPO VERIFIED THAT OVERHEAT SOURCES CORRECTLY IDENTIFIED**
- **DEMONSTRATION - GROUND DEMO SATISFACTORILY COMPLETED; FLIGHT DEMO WILL BE COMPLETED BY MAY 93**
- **TEST - SMOKE DETECTION AND AGENT CONCENTRATION TO BE COMPLETED BY MAY 93**



# C-17 CONVENTIONAL HARDENING DESIGN FEATURES

AIRCRAFT SUBSYSTEM	ALLOCATED REQUIREMENTS				
	REDUNDANCY	SEPARATION	ISOLATION	SHIELDING	FIRE/ EXPLOSION SUPPRESSION
FUEL SYSTEM	X	X	X		X
CREW SYSTEM	X	X	X	X	X
FLIGHT CONTROLS	X	X			
PROPULSION	X	X		X	X
HYDRAULICS	X	X	X		X
ELECTRICAL	X	X	X		X
STRUCTURE	X	X			



# C-17 NON-NUCLEAR HARDENING DESIGN FEATURES

AIRCRAFT SUBSYSTEM	DESIGN GUIDELINE				
	REDUNDANCY	SEPARATION	ISOLATION	SHIELDING	FIRE/ EXPLOSION SUPPRESSION
FUEL SYSTEM	4 TANKS, 2 ENGINE FEED PUMPS PER TANK, SUCTION FEED CAPABILITY	TANKS, PUMPS	FUEL FLOW CONTROL		ULLAGE INERTING, PROVISIONS FOR SELF-SEALING LINES
CREW SYSTEM	2 OXYGEN TANKS	OXYGEN TANKS	OXYGEN SYSTEM CONTROLS	PROVISIONS FOR CREW ARMOR	OXYGEN SYSTEM COMPONENT LOCATION AND LINE ROUTING
FLIGHT CONTROLS	4 CHANNEL FLY-BY-WIRE + MANUAL BACKUP	WIRE AND HYDRAULIC LINE ROUTING			
PROPULSION	4 ENGINES	ENGINES WIDELY SPACED, INDEPENDENT FUEL SUPPLIES		BLADE CONTAINMENT	FUEL SHUTOFF, FIRE WALL, NACELLE FIRE EXTINGUISHER
HYDRAULICS	4 INDEPENDENT SYSTEMS, AIR DRIVEN BACKUP	COMPONENTS WIDELY SPACED	DEPRESSURIZED WHEN NOT IN USE		MIL-H-83282 FLUID (FIRE RESISTANT)
ELECTRICAL	4 GENERATORS, BATTERY POWERED EMERGENCY BACKUP, 2 POWER CONTROL CENTERS	GENERATORS, WIRE ROUTING	ELECTRICAL SYSTEM CONTROLS		WIRE ROUTED AWAY FROM FUEL, OXYGEN, & HYDRAULIC LINES; KAPTON USAGE RESTRICTED
STRUCTURE	MULTIPLE LOAD PATHS	CRACK STOPPERS			



# BALLISTIC TEST SUMMARY

*Avionics  
Rack  
Chart  
added*

- PURPOSE OF TESTING: FILL VOIDS IN DATA BASE

ITEMS	COMPONENT Pk	PENETRATION AND SHIELDING	FIRE	FIRE/ EXPLOSION SUPPRESSION
DEVELOPMENT TEST				
FLAP HINGE	X			
ARMOR CLIP	X			
OBIGGS BOTTLE	X			
UPPER WING SKIN		X		
ESCAPE SYSTEM ACCUMULATOR	X			
FUEL TANK INERTING (DEV)*				X
WING LEADING EDGE (LFT)			X	
LFT PLANNED				

*in work*

\* MEASUREMENT OF OXYGEN LEVEL USING GROUND AND FLIGHT TESTS

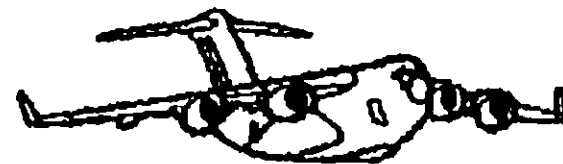

# VULNERABILITY ASSESSMENT



# METHODOLOGY

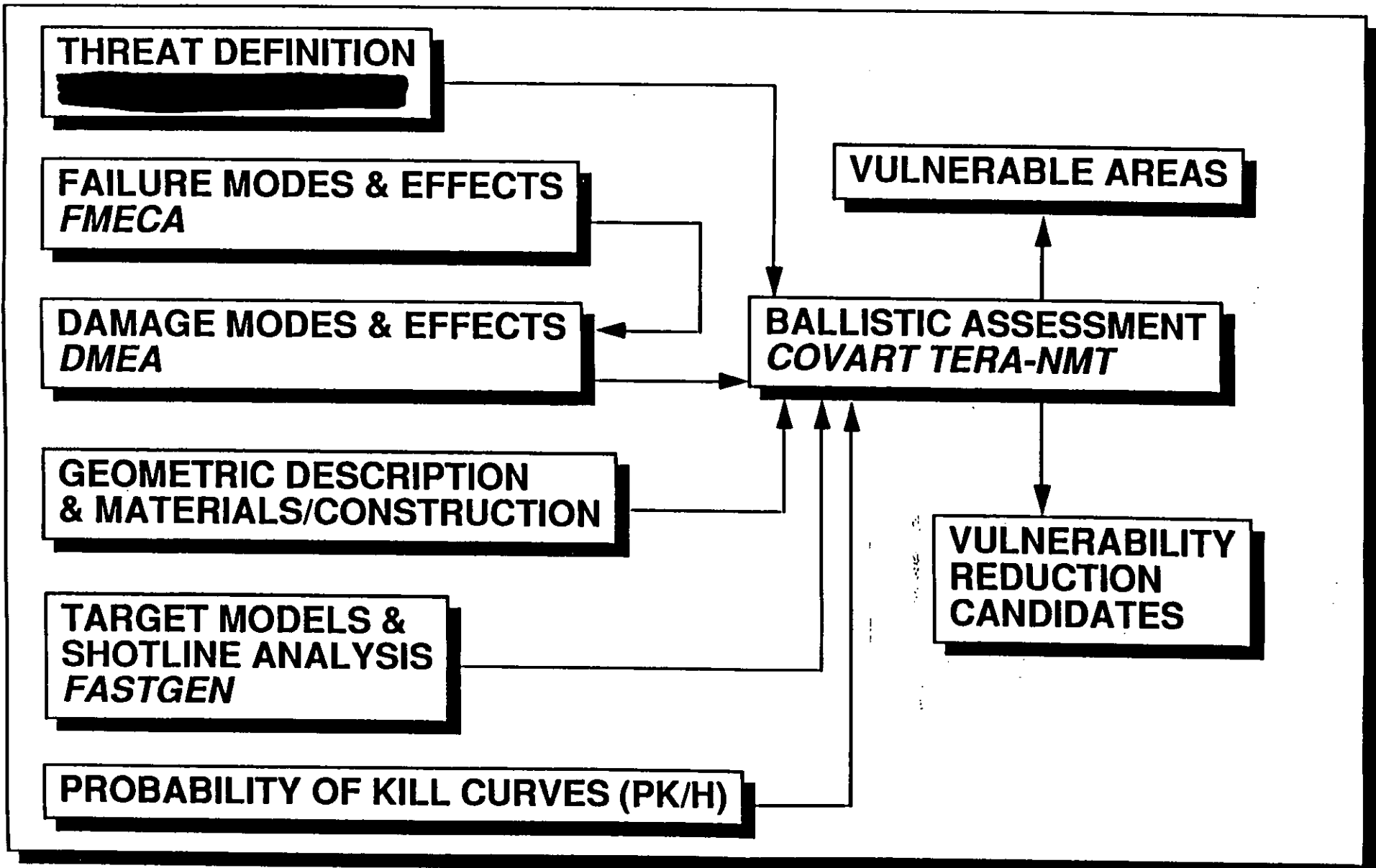



# **METHODOLOGY**

- **API AND FRAGMENT ANALYSIS**
  - **FASTGEN 3 / COVART II**
  - **26 VIEWS USING 3" GRID**
  - **2 MILLION SHOTLINES / THREAT / VELOCITY**
  
- **HEI ANALYSIS**
  - **TERMINAL EFFECTS RESEARCH AND ANALYSIS (TERA) SOFTWARE BY NEW MEXICO TECH**
  - **6 VIEWS USING 6 INCH GRID**
  - **36 MILLION SHOTLINES / THREAT / VELOCITY**





# **THREAT DEFINITION**

- **DESIGN REQUIREMENT**
  - **12.7 mm API**
- **ANALYSIS REQUIREMENT**
  - **PROJECTILES**  
**EVALUATE - 7.62 mm, 12.7 mm, 14.5 mm, AND 23 mm API**  
**VELOCITIES - 500 - 3500 fps IN 500 fps INCREMENTS**
  - **FRAGMENTS**  
**EVALUATE - 45, 70, 105, 120, 240, 480 GRAIN CUBES**  
**VELOCITIES - 1000 - 10,000 fps IN 1000 fps INCREMENTS**
  - **AAA (CONTACT FUSED)**  
**EVALUATE - 23mm HEIT AND 57MM HE-T**  
**VELOCITIES - 2200 fps**
  - **SAMs**  
**EVALUATE - SA-7 (CONTACT FUSED)**  
**VELOCITY - 1800 fps**  
**EVALUATE - SA-6 ENDGAME (PROXIMITY FUSED)**  
**VELOCITY - 1100 - 2200 fps IN 100 fps INCREMENTS**



# SHOT LINE GENERATION

- GRID SUPERIMPOSED ON GEOMETRIC DESCRIPTION
- SHOT LINE RANDOMLY LOCATED WITHIN EACH CELL
- PREPARES AN ITEM-BY-ITEM LIST FOR EACH SHOT LINE OF:
  - COMPONENTS ENCOUNTERED
  - OBLIQUITY ANGLES
  - THICKNESSES
  - LOCATIONS ALONG SHOTLINE

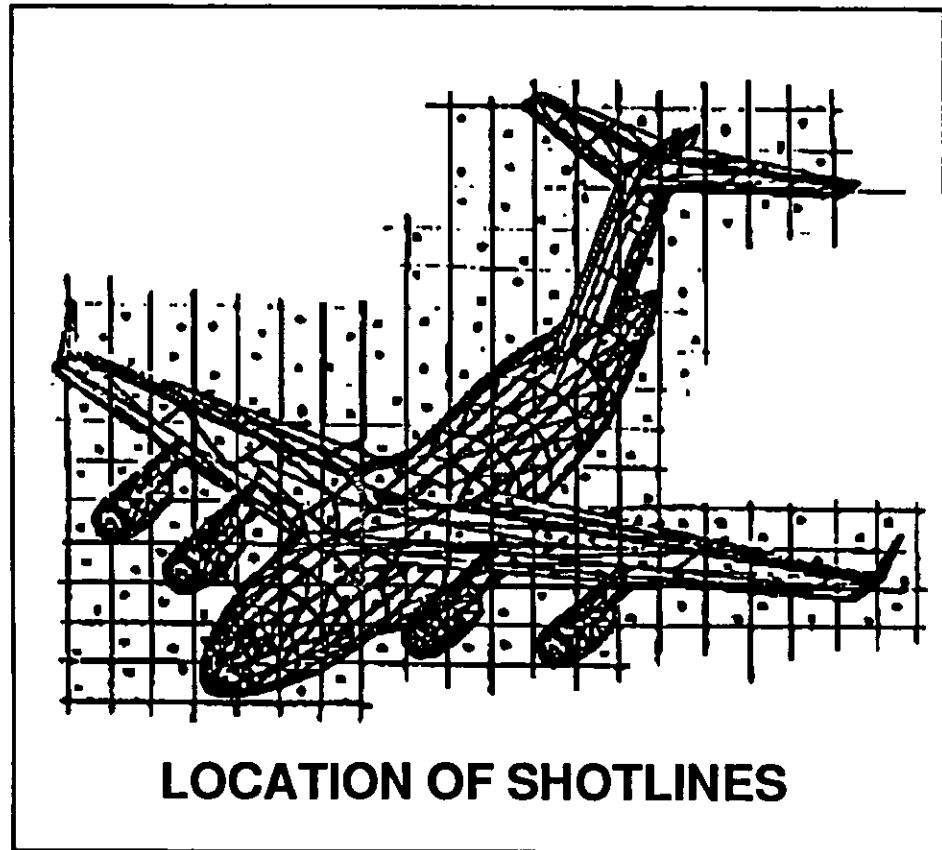

# Probability of Kill Given a Hit ( $P_{K/H}$ )

*One of  
122  
tables*

## • Kill Mechanism

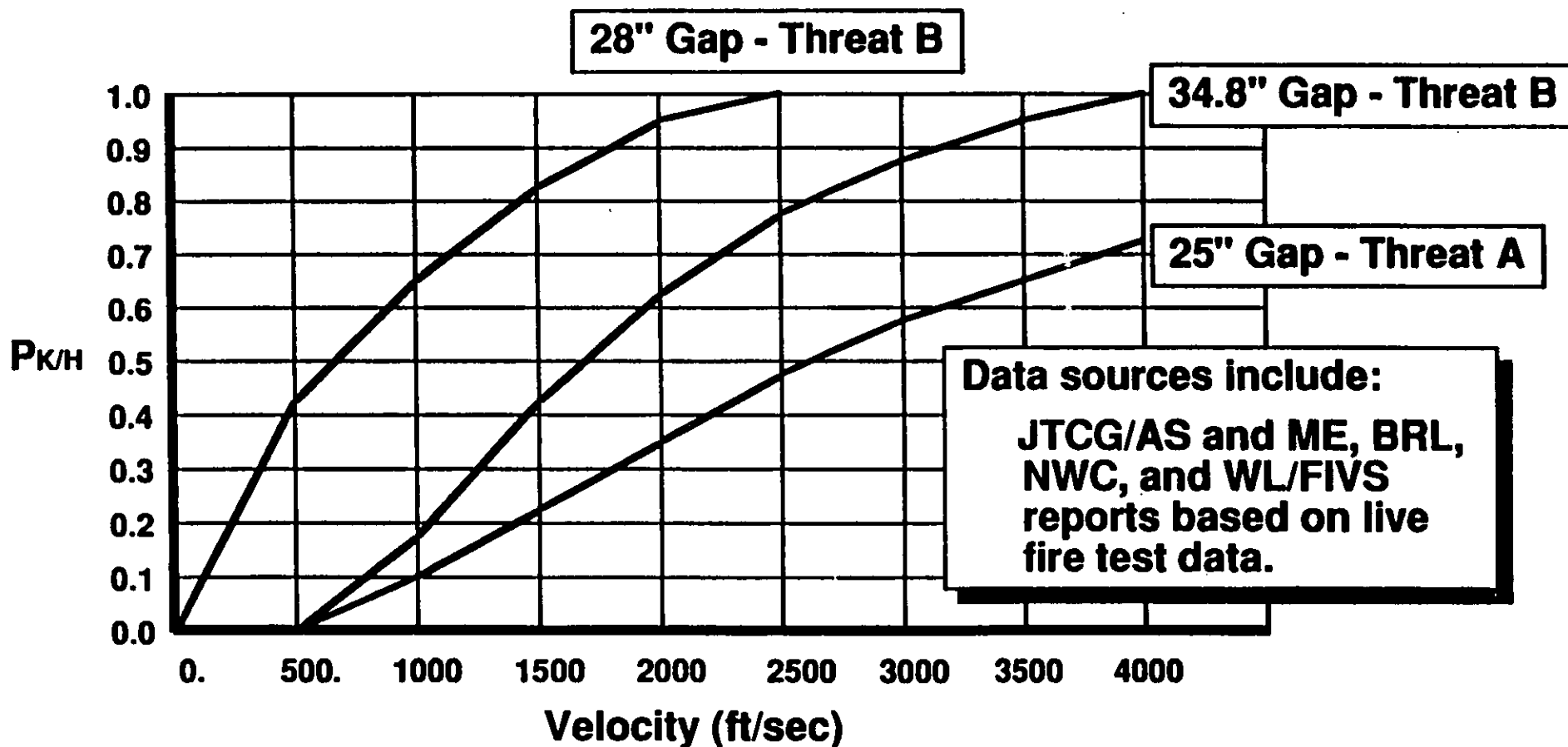



# C-17 CONVENTIONAL THREAT EFFECTS

AIRCRAFT SUBSYSTEM	KILL MECHANISMS				
	HYDRAULIC RAM	FIRE	LOSS OF SUBSYSTEM FUNCTION	EXPLOSION	ENGINE BLADE CONTAINMENT
FUEL SYSTEM	X 1	X 3, 4	X 2	X 4	X 2
CREW SYSTEM			X 2		
FLIGHT CONTROLS			X 2		X 2
PROPULSION		X 2	X 2		X 2,5
HYDRAULICS		X 2	X 2		X 2
ELECTRICAL			X 2		X 2
STRUCTURE			X 1c		

- 1.a. MASSIVE WING BOX STRUCTURE
- 1.b. FUEL ONLY IN WING STRUCTURE
- 1.c. ENGINEERING JUDGMENT - NOT AIRCRAFT KILLER
- 2. SUBSYSTEM IS REDUNDANT, SEPARATED, AND ISOLATED
- 3. LIMITED PROTECTION (FIRE SUPPRESSION SYSTEM, LOADMASTER)
- 4. NITROGEN INERTING - OBIGGS
- 5. BLADE CONTAINMENT - FAA CERTIFIED



# **ANALYSIS IMPACTS ON DESIGN**

- **RELOCATING PYLON HYDRAULICS LINES**
  - **LOSS OF THREE SYSTEMS BY SINGLE SHOT RESULTED IN ONE LINE BEING ROUTED DIRECTLY THROUGH FUEL TANK RATHER THAN ALONG FRONT SPAR**
- **RELOCATION OF FLIGHT CONTROL COMPUTER AND INERTIAL REFERENCE UNITS**
  - **INCREASED SEPARATION BY 30 INCHES LATERALLY AND 15 INCHES LONGITUDINALLY**
- **PRIMARY AND BACKUP ENGINE CONTROL WIRING SEPARATED**
- **POTENTIAL FLAP HINGE VULNERABILITY IDENTIFIED**
- **POTENTIAL FLAP TANDEM CONTROL VALVE VULNERABILITY IDENTIFIED**
- **KAPTON WIRING ELIMINATED FROM LEADING EDGE**

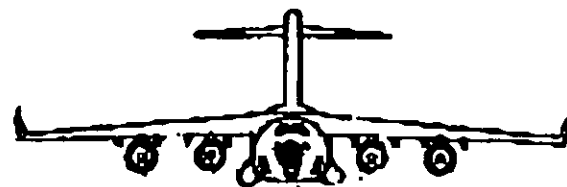

# **POTENTIAL SURVIVABILITY ENHANCEMENTS AND STUDIES**



# LEADING EDGE FIRE PROTECTION

**WEIGHT (INSTALLED)**

**+225 LBS**

**MMH/FH**

**+.00055**

**COST**

**~\$10 MILLION**

**PYLON**

**PYLON**

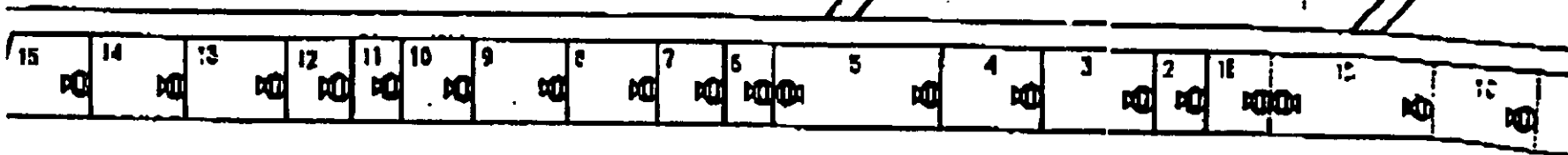



# **SURVIVABILITY ENHANCEMENTS**

## **CREW, TROOPS, AND CARGO (12.7 mm API)**

### **OBJECTIVE**

**PROTECT PILOT, CO-PILOT AND  
LOADMASTER POSITIONS**

**PROTECT CARGO COMPARTMENT  
(ALLOWS FOR 30 DEGREE BANK  
DURING APPROACH)**

**PROTECT LEADING EDGE DRY BAY**

### **IMPACT**

**1738 LBS - WARTIME ONLY**

**12,348 LBS (7 LBS / SQ FT)  
PERMANENT**

**ARMOR MATERIAL FOR  
BOTH IS AL<sub>2</sub>O<sub>3</sub> / 52  
FIBERGLASS OR  
EQUIVALENT**

**225 LBS - HALON BOTTLES  
AND SENSORS**





# **SURVIVABILITY ENHANCEMENTS**

## **CREW, TROOPS, AND CARGO**

**(23 mm API)**

### **OBJECTIVE**

### **IMPACT**

**PROTECT PILOT, CO-PILOT, AND  
LOADMASTER POSITIONS**

**5314 LBS (21 LBS / SQ FT)**

**PROTECT TROOPS & CARGO  
(ALLOWS FOR 30 DEGREE BANK  
DURING APPROACH)**

**37,044 LBS (21 LBS / SQ FT)**

**MATERIAL FOR BOTH IS  
1" THICK TITANIUM**

**PROTECT LEADING EDGE DRY BAY**

**225 LBS - HALON BOTTLES  
AND SENSORS**



# S/V ANALYSIS ALTERNATIVES

- **26 VVA WITH OTHER THREATS (30 mm HEI / API, SA-14)**
  - **USE HEIVAM AND MISSILE FLY-OUT MODELS**
  - **PERFORM SENSITIVITY ANALYSIS / TRADE STUDIES**
    - **LIFE CYCLE COST FOR PERCENTAGE (20, 50, 80) REDUCTION OF VULNERABLE AREA**
    - **TEST AS REQUIRED**
  - **VALIDATE DESIGN FIXES WITH ITERATIONS OF 26 VVA MODEL**
  - **3 1/2-YEAR EFFORT; ~ 40,000 MANHOURS**

**- OR -**

- **USE CURRENT VULNERABILITY ANALYSIS TO IDENTIFY VULNERABLE AREAS TO HIGHER ORDER (23 mm & ABOVE) THREATS**
  - **ASSUME VULNERABILITY TO 23 mm & 30 mm - SCALEABLE**
  - **ASSUME SA-7 & SA14 HAVE THE SAME CAPABILITY**
  - **PERFORM SIMILAR SENSITIVITY ANALYSIS**
  - **NO COMPUTER MODELING REQUIRED**
  - **2-YEAR EFFORT; ~ 50 MANHOURS**

*15,000*



# **OTHER S/V ANALYSES (NOT CURRENTLY REQUIRED)**

- **IDENTIFIED AS CANDIDATES THROUGH PREVIOUS LFT DISCUSSIONS**
  - **PARKED AIRCRAFT VULNERABILITY**
    - **1 YEAR; ~ 3000 MANHOURS**
  - **VULNERABILITY DUE TO CARGO**
    - **6 MONTHS; ~ 2000 MANHOURS**
  - **PASSENGER VULNERABILITY**
    - **PARALLEL EFFORT WITH CARGO STUDY**
    - **6 MONTHS; ~ 1000 MANHOURS**
  - **ENGINE DISC FAILURE (OTHER THAN HYDRAULIC)**
    - **6 MONTHS; ~ 1000 MANHOURS**

# OVERVIEW OF LFT&E FOR AIRCRAFT

19 MARCH 1992

PRESENTED BY:

James F. O'Bryon, Director, Live Fire Testing  
Albert Rainis  
Dale Atkinson

*O'Bryon final comments -*

- 1) Need to have dehydrator*
- 2) Must be early/after*
- 3) LFT must be integrated*
- 4) Must plan assets (#, range, assets/early)*

*Wants this to work / Must have teamwork*

# OBJECTIVES

# JLF VERSUS LFT&E

## JOINT LIVE FIRE

- CHARTERED FY 84
- MULTI-SERVICE MANAGEMENT
- OSD FUNDED
- • FIELDDED SYSTEMS
- LETHALITY & VULNERABILITY
- LAND AND AIR SYSTEMS
- TEST EVENT
- OVERSIGHT FROM OSD

## LIVE FIRE TESTING

- LEGISLATED FY 87
- PRIMARILY INDIVIDUAL SERVICE
- SERVICE FUNDED
- DEVELOPMENTAL SYSTEMS ←
- LETHALITY & VULNERABILITY
- LAND, AIR & SEA SYSTEMS
- ACQUISITION MILESTONE RELATED
- OVERSIGHT FROM OSD
- MAJOR MODIFICATIONS (THAT MIGHT AFFECT VULNERABILITY)

# OBJECTIVES OF JLF

- **GATHER EMPIRICAL DATA ON THE VULNERABILITY OF U.S. SYSTEMS TO FOREIGN WEAPONS AND THE LETHALITY OF U.S. WEAPONS AGAINST FOREIGN TARGETS**
- **PROVIDE INSIGHT INTO DESIGN CHANGES NECESSARY TO REDUCE VULNERABILITIES AND IMPROVE LETHALITIES OF U.S. WEAPONS**
- **ENHANCE THE DATA BASE AVAILABLE FOR BATTLE DAMAGE ASSESSMENT AND REPAIR**
- **VALIDATE CURRENT VULNERABILITY AND LETHALITY METHODOLOGIES**

LESSONS LEARNED FLOWS INTO  
LIT PROGRAM

## **OBJECTIVES OF LFT&E**

**ENSURE THAT KNOWLEDGE OF CREW CASUALTIES AND SYSTEM VULNERABILITIES\***

- **IS BASED ON TESTING UNDER REALISTIC COMBAT CONDITIONS**
- **SUPPORTS DECISION MAKERS (IS TIMELY)**
- **OCCURS SUFFICIENTLY EARLY TO IMPACT DESIGN**

---

**\*Lethality, for munitions programs.**



# REQUIREMENTS

# LIVE FIRE LEGISLATION

- **REQUIREMENT FOR LFT**
  - **Realistic survivability/lethality testing (LFT)**
    - **Full-up, combat configured**
    - **Realistic threat ("likely to be encountered in combat")**
    - **Emphasis on crew casualties**
  - **Early enough to correct design**
    - **Deficiencies identified in LFT**
    - **Encourages early testing**
  - **Reported by SECDEF to Congress before full production**

# LIVE FIRE LEGISLATION (CONT'D)

- **PROVISION FOR WAIVER**

- **From all provisions**
  - **By President**
  - **In time of war**
- **From full-up LFT**
  - **By MS II**
  - **By SECDEF**
  - **If unreasonably expensive and impractical**
  - **Accompanied by alternative assessment plan**

*- Modeling fuel system, w/ fuel  
incursions, etc.*

*• After Milestone II,  
legislative relief required.*

# SELECTED LFT & E SYSTEMS

ARMY	AIR FORCE	NAVY
<u>Aircraft</u>	<u>Aircraft</u>	<u>Aircraft</u>
AH-64D LONGBOW APACHE Armed OH-58D (AHIP) MH 47-E MH 60-K RAH-66 COMANCHE	AC-130 C-17A F-16 (CAS/BAI) F-22	AV-8B AX Attack Aircraft F/A-18 E/F V-22
<u>Other LFT&amp;E</u>	<u>Other LFT&amp;E</u>	<u>Other LFT&amp;E</u>
AGS ASM ASM (AFAS) ASM (BLOCK III Tank) ASM (CMV) ASM (FARV-A) ASM (FIFV) JAVELIN LOSAT ATACMS BAT DRAGON PIP FAADS LOS-F-H (ADATS) HELLFIRE (AGM-141A) M1 Tank Block 2 M113 Spall Liner M109A3 155 MM (HIP) MLRS-TGW SADARM Wide Area Mine M830-E1 (120MM) M900-E1 (105 MM) M919 (25 MM)	AMRAAM SFW	AAAM AAV (Adv Amph Assault) Advanced Bomb Family AIWS DDG-51 HARM Bik III (AGM-88B) LX Amphib AST Ship SSN-21 STD MSI-2 Bik III/IIIA TOMAHAWK TLAM-C Bik III Torpedo MK-50

*O'Sygn acknowledges  
 that C-17 not a covered  
 system but listed since  
 his office will provide  
 oversight.*

# CONCEPTS

# SURVIVABILITY: IMPROVING THE ODDS

$$P_S = 1 - (P_{HIT}) (P_{KILL/HIT})$$

## SUSCEPTIBILITY

- AGILITY
- SIGNATURE REDUCTION
- COUNTERMEASURES
- WARNING/DECEPTION
- THREAT SUPPRESSION

## VULNERABILITY

- DAMAGE TOLERANCE
- DAMAGE RESISTANCE
- BATTLE DAMAGE REPAIR
- CREW PROTECTION

# SCOPE OF LFT&E THREAT CONSIDERATIONS

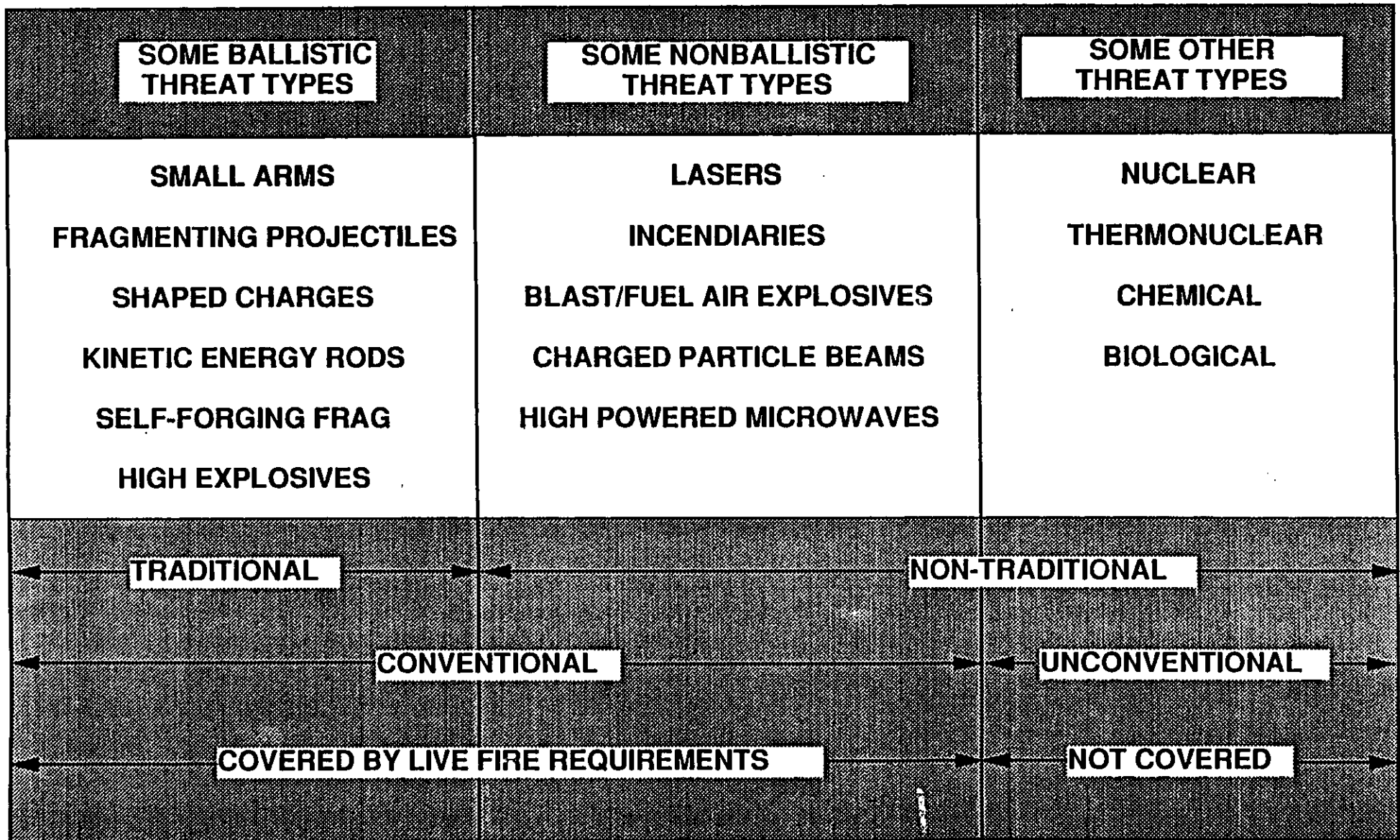

# OPERATIONAL CONSIDERATIONS FOR LFT&E

- **TESTING**

- Threat weapons "likely to be encountered in combat"
- Shot selection from realistic combat distribution

*- NOT A "DESIGN TAKEAWAY"  
- JUST WHAT'S IN THE STAR.*

- **EVALUATION: IN CONTEXT OF**

- Operational effects of damage
- Susceptibilities established through OT&E
- Tactical doctrine
- Historical evidence

**"... taking into equal consideration the susceptibility to attack and combat performance of the system"**



# LIVE FIRE TESTING — NOT JUST AN EVENT

*ANALYSIS? (Why not show?)*

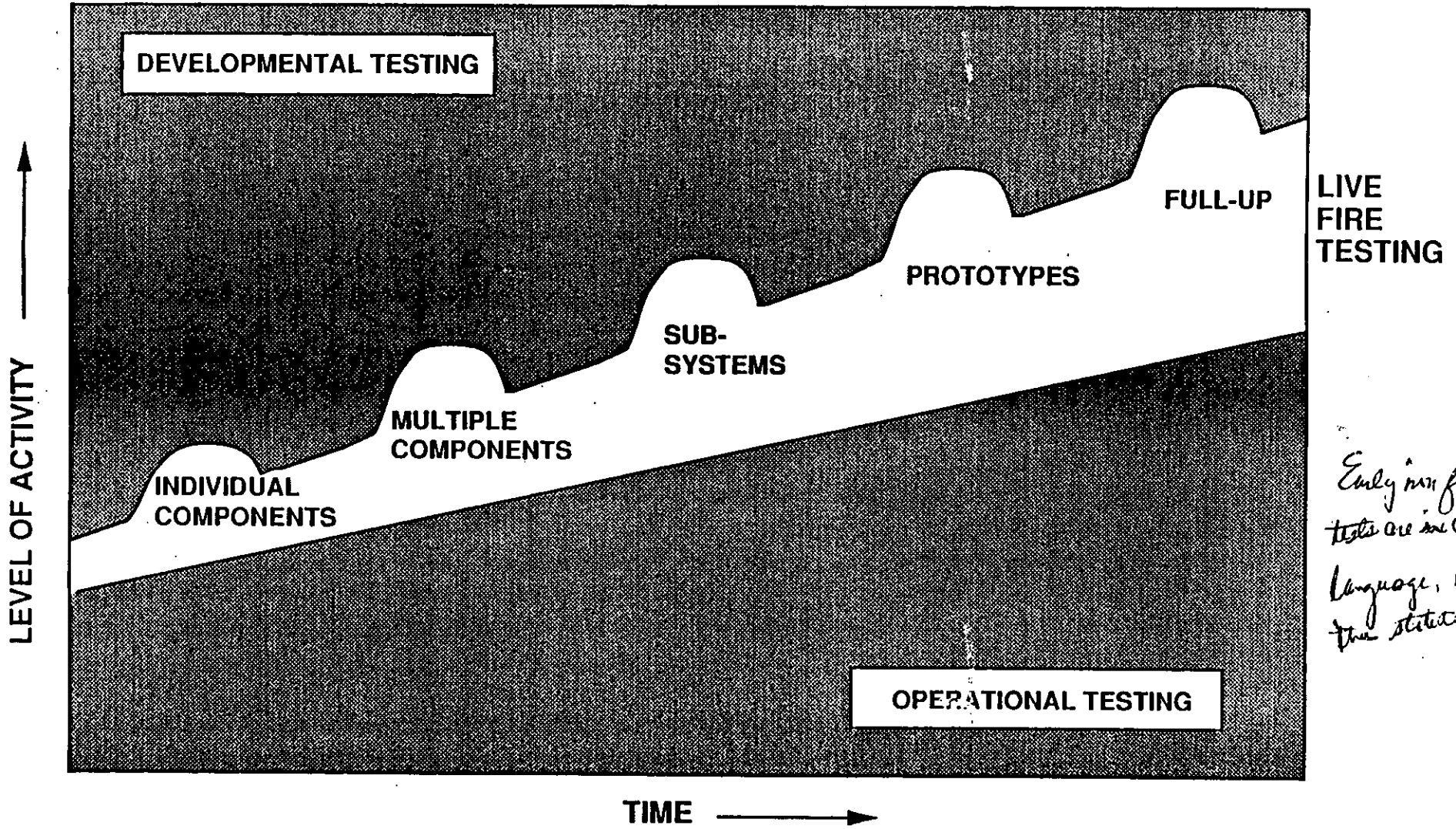

*Early on fellows  
tests are in common  
language, not in  
the statute.*

# WHAT DISTINGUISHES AN LFT FROM OTHER VULNERABILITY TESTS?

## FULL-UP LFT

- FULL-UP TEST OF COMBAT CONFIGURED SYSTEM

## OTHER LIVE FIRE TESTS

- LABELED AS LFT IN TEMP LFT&E STRATEGY (VS. SUPPORTING TEST)
- BASED ON LFT&E ISSUES
- OSD OVERSIGHT
- TEST PLANS TO LFTO FOR REVIEW AND COMMENT
- PRE-TEST PREDICTIONS

# **WAIVER PROCESS — DISTINCT FROM NOMINATION PROCESS**

- **NOMINATION PROCESS**

- **Determines whether program meets legislative criteria**
- **Does not address viability of full-up testing**

- **WAIVER PROCESS**

- **Based on viability of full-up testing**
- **System not removed from nomination list**
- **Within LFT&E, but Live Fire Testing would not culminate in full-up test**
- **In compliance with the law, if Sec Def decision is by MS II (not a request for relief from the law)**

## **SOME MISCONCEPTIONS REGARDING LIVE FIRE TESTING**

- **NOT A COMPUTER MODELING EXERCISE (BUT DOES CALIBRATE MODELS)**
- **NOT A STATISTICAL EXERCISE (NOR IS MOST OTHER ACQUISITION-RELATED TESTING)**
- **NOT THE SAME AS JOINT LIVE FIRE**
- **NOT AN EXPERIMENT**
- **NOT A PURE PASS/FAIL EXERCISE (FIRST ORDER INSIGHTS)**
- **NOT ALL BAD NEWS (SOME GOOD NEWS)**

## **SOME MISCONCEPTIONS REGARDING LIVE FIRE TESTING (CONT'D)**

- **NOT TESTING TO DESIGN (IT'S TESTING TO EXPECTED THREAT)**
- **NOT WORST CASE TESTING (IT'S REALISTIC TESTING)**
- **NOT JUST AN EVENT (IT'S A SERIES OF EVENTS)**
- **NOT ONLY ASSESSMENT OF HARDWARE (ALSO CREW CASUALTY ASSESSMENT)**
- **NOT ASSESSMENT OF VULNERABILITY ONLY (ALSO LETHALITY)**

## **SOME MISCONCEPTIONS REGARDING LIVE FIRE TESTING (CONT'D)**

- **NOT SAME AS BALLISTIC TESTING (OTHER CONVENTIONAL EFFECTS ALSO)**
- **NOT TOTAL SURVIVABILITY TESTING (ONLY DAMAGE DUE TO A HIT)**
- **NOT PURELY DEVELOPMENTAL TESTING**
- **NOT PURELY OPERATIONAL TESTING**
- **NOT ADVERSARIAL (INDEPENDENT)**
- **NOT JUST TESTING (ALSO EVALUATION)**
- **NOT BUSINESS AS USUAL (NEW CONGRESSIONAL/OSD REQUIREMENT)**

# **LFT&E PROGRAM IMPLEMENTATION**

# CRITERIA FOR EVALUATING AN LFT&E PROGRAM

- THREAT BASED - SPECIFIC THREAT WEAPONS
- TEST BASED - ASSESSMENT DIRECTLY RELATED TO TESTING
- REALISTIC - COMPARED TO THE FULL-UP REQUIREMENT
- SUPPORTS ACQUISITION DECISION - ADDRESSES CRITICAL ISSUES
- DESIGN RELATED - IN TIME TO CORRECT ANY DESIGN FLAWS



# **LFT&E ISSUES FOR AIRCRAFT**

- **OVERARCHING ISSUE — VULNERABILITY TO THREAT**
- **SYSTEM SPECIFIC ISSUES**
  - **Satisfaction of relevant requirements**
  - **Crew casualties (e.g., safe ejection)**
  - **Comparison with existing system**
  - **Demonstrate effectiveness of vulnerability reduction design features**
  - **Vulnerabilities from stowed/carried munitions**
  - **Uncertainties concerning contribution to system vulnerability of subsystems/damage mechanisms/threats (e.g., DEW)**

# INFORMATION SOURCES FOR LFT&E

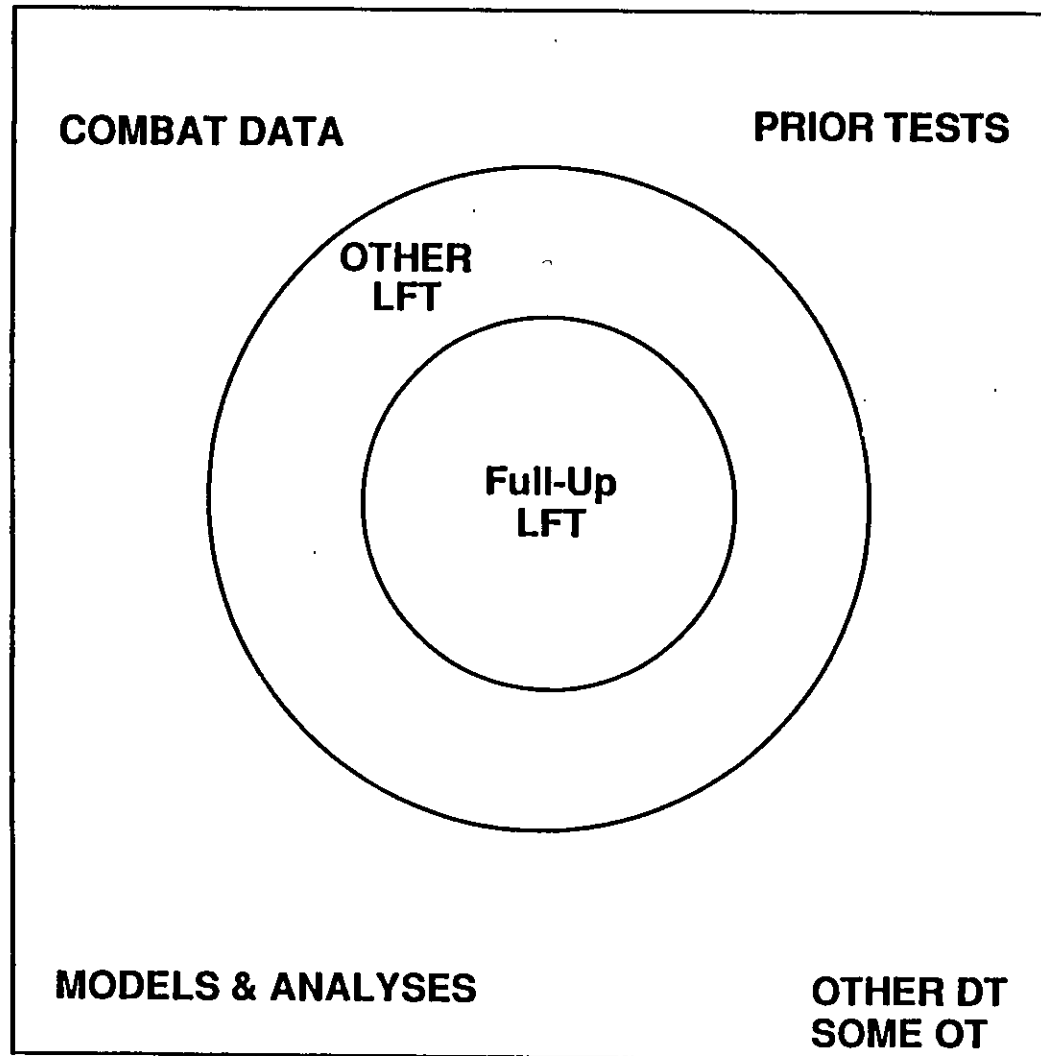

# INTEGRATED TEST PROGRAM SCHEDULE (ILLUSTRATIVE EXAMPLE)

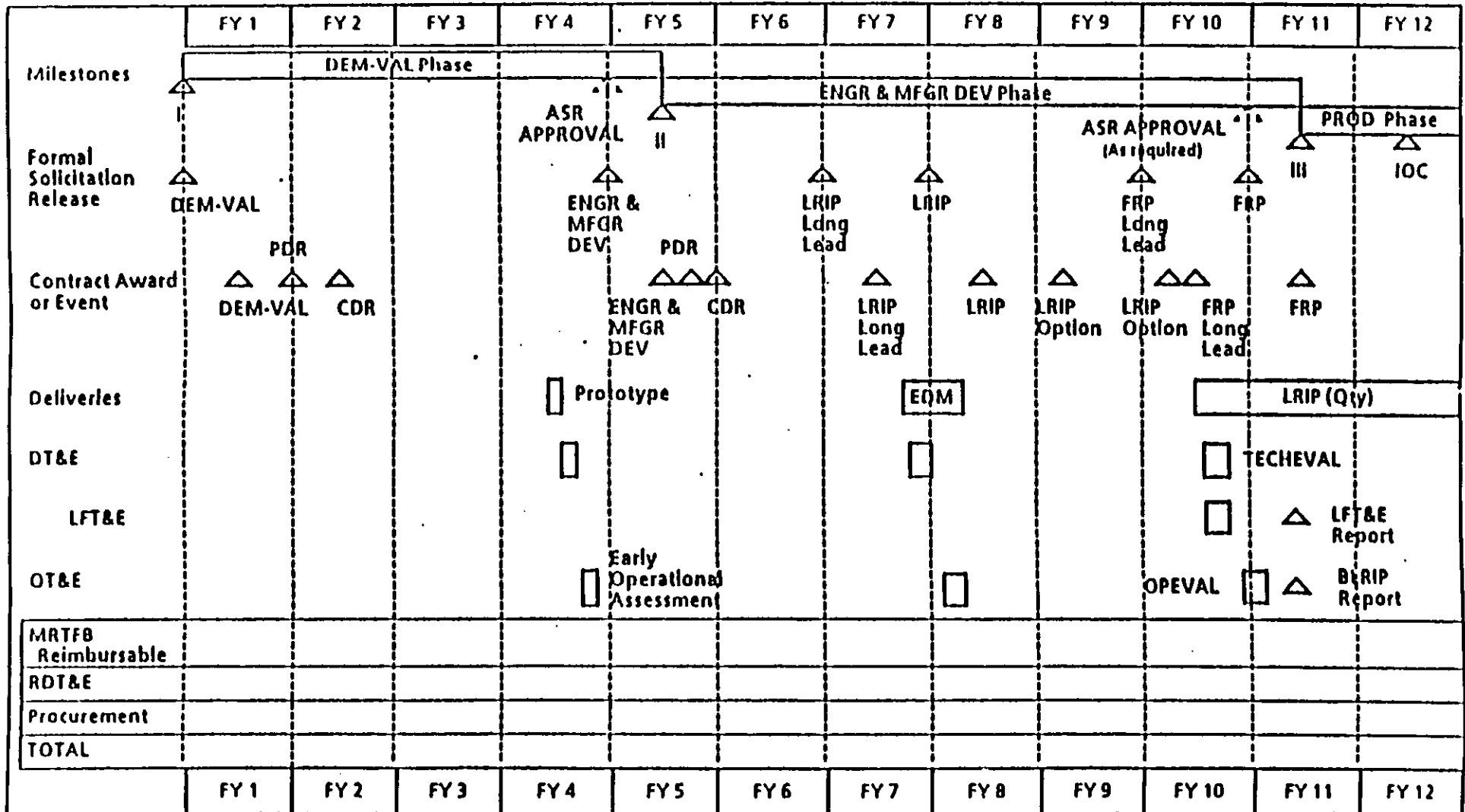

Source: DoD 5000.2-M, February 1991

# LFT&E CONCERNS IN SUPPORT OF MILESTONE DECISIONS

MILESTONE	DECISION	LFT&E CONCERNS PRIOR TO DECISION
		<ul style="list-style-type: none"> <li>• FIRST SERVICE STRATEGY</li> <li>• LFT&amp;E ISSUES</li> <li>• IDENTIFY SUPPORTING DATA</li> </ul>
I	DEM-VAL	
		<ul style="list-style-type: none"> <li>• COMMITMENT TO FULL-UP TESTING/ REQUEST FOR WAIVER</li> <li>• DEFINITION OF EXIT CRITERIA</li> <li>• PLAN FOR EARLY TESTING</li> </ul>
II	ENGR/MFGR DEV	
		<ul style="list-style-type: none"> <li>• CONDUCT OF PROGRAM</li> <li>• EMERGING ISSUES</li> </ul>
	LRIP	
		<ul style="list-style-type: none"> <li>• INDEPENDENT ASSESSMENT</li> </ul>
III	PROD	

*C. Bryan - Need to ensure  
Trust*

# PRODUCTS OF THE LIVE FIRE TEST OFFICE

PRODUCT	THROUGH	RECIPIENT
TEMP* comments and recommendation for approval	DDDRE(T&E)	Service/DDDRE(T&E)
Detailed Test Plan* comments	DDDRE(T&E)	Service
Blue Book input	DDDRE(T&E)	CSC, DAB
Independent Assessment Report	USD(A)/SECDEF	Congress

*Prin. C. 10/1/11*

\*Initiated by Service.

# POSSIBLE SOURCES OF TEST ARTICLES FOR AIRCRAFT LFT&E

- PRODUCTION AIRCRAFT/SECTIONS
- FATIGUE TEST ARTICLES
- STATIC TEST ARTICLES
- PROTOTYPES
- SURROGATES

*Cautious about "one  
flipped" test article. Someone  
can't come back later and  
say bad test if they provided  
the test article.*

# LIVE FIRE TEST ACQUISITION PROCESS CONCERNS

- LACK OF UNDERSTANDING BY SERVICE PROPONENTS OF TOTAL IMPACT/BENEFIT OF LFT ON AIRCRAFT
- NEED TO RAMP UP TO MS III THROUGH INTERIM LFT EXIT CRITERIA (E.G., COMANCHE)
- DEDICATION OF AIRCRAFT ASSETS AND BUDGET IN T&E STRATEGY TO SUPPORT LFT&E

*In the TEMP over the LFT Plan?*

# **KEYS TO CONDUCTING EFFECTIVE LIVE FIRE TESTING OF AIRCRAFT**

- **UNDERSTAND LEGISLATIVE AND OSD TEST REQUIREMENTS**
- **ASSURE THAT ADEQUATE TEST RESOURCES ARE IDENTIFIED EARLY**
- **IDENTIFY CRITICAL LIVE FIRE TESTING ISSUES EARLY**
- **MATCH TESTS TO CRITICAL ISSUES**
- **INTEGRATE LFT&E INTO OVERALL TESTING STRATEGY (TEMP)**
- **GAIN ACCESS TO AND EVALUATE ALL RELEVANT COMBAT DATA ON SIMILAR SYSTEMS**
- **MAINTAIN CONSISTENCY BETWEEN OPERATIONAL REQUIREMENTS AND LIVE FIRE TESTING CRITERIA**
- **ASSURE THAT TESTS EMPLOY REALISTIC FUTURE THREAT (IOC AND DURING ANTICIPATED FIELDING OF SYSTEM)**
- **USE MOST UP-TO-DATE VULNERABILITY MODEL TO MAKE PRESHOT DAMAGE PREDICTIONS**
- **BALANCE TESTING AND EVALUATION**



**BACKUP**

# **FULL-UP TESTING**

- **CULMINATION OF EARLY LFT, SUPPORTING TESTS**
- **WHAT THE LAW CALLS FOR**
  - **Complete system**
  - **Combat configured**
  - **Emphasis on user casualties**
  - **Operational considerations**
- **NON-INTUITIVE EFFECTS**
  - **Synergisms/cascading damage**

## **COMBAT CONFIGURED**

- **ALL DANGEROUS MATERIALS THAT WOULD NORMALLY BE ON BOARD**
- **FLAMMABLES (E.G., FUEL, HYDRAULIC FLUID)**
- **EXPLOSIVES (E.G., STOWED MUNITIONS)**
- **REQUIRED FOR FULL-UP LFT**

## **CASCADING DAMAGE**

- **HAS SIGNIFICANT EFFECT ON AIRCRAFT VULNERABILITY**
- **DAMAGE IS NOT ALONG SHOTLINE**
- **DAMAGED COMPONENT BECOMES ITSELF A SOURCE OF DAMAGE TO ANOTHER COMPONENT (E.G., HYDRAULIC RAM, FUEL INGESTION KILLS)**
- **"CREATES" ANOTHER CRITICAL COMPONENT**
- **DAMAGE MAY OR MAY NOT BE SEVERE ENOUGH TO CAUSE LOSS OF AIRCRAFT**



OFFICE OF THE DIRECTOR OF  
DEFENSE RESEARCH AND ENGINEERING

WASHINGTON, DC 20301

3 FEB 1992

MEMORANDUM FOR ASSISTANT SECRETARY OF THE AIR FORCE/ACQUISITION

SUBJECT: C-17 Live Fire Test and Evaluation (LFT&E)

JACK -

Last year, we had several meetings with Air Force personnel responsible for the test and evaluation of the C-17, including the Live Fire Testing of this aircraft. During those meetings, we made clear our concerns and the need to address them before the end of December 1991 to minimize the probability that the acquisition schedule for the C-17 would be delayed.

We have now entered 1992 and still have not reached closure. The process of closure on the C-17 LFT&E Strategy must be accelerated to arrive at a schedule to complete LFT&E before the Full-Rate Production decision. To do this, I need the following as soon as possible:

- Realistic cost estimate of an LFT&E strategy reflecting the above issues, breaking out the cost of the test article(s) from the actual cost of test conduct.
- Additional testing (and test approach) for munitions identified in the System Threat Assessment Review (STAR)  
[REDACTED]
- Availability of potential test assets, such as portions of the static test article, that could be used for LFT&E.

We appreciate the assistance that the Program Executive Officer and System Program Office (SPO) are providing gathering existing information. My staff estimates that our preliminary analyses will be completed around May because of the sheer volume of information recently delivered to us by the Air Force that must be processed.

Unfortunately, our staff work alone will not result in a total resolution of the issues. It is going to require some concurrent efforts with the Air Force on several of the major issues.

For example, our continuing assessment of the Air Force fabricated leading edge surrogate has raised more questions than it has answered. Demonstrating that the test article is equivalent to an actual C-17 wing in all respects -- even for testing only 12.7 mm -- may not be possible. Testing a production-representative test article, as part of a complete strategy will be needed to respond to concerns that I and my staff have expressed.

I request your personal help and intervention on this matter. I want to re-examine the C-17 issues and schedule a date for an Air Force briefing to us. The briefing we are requesting is currently in preparation by your staff per earlier correspondence from this office (see Attachment).



Charles E. Adolph  
Deputy Director  
(Test and Evaluation)

Attachment

cc: DDDRE(TWP)  
DDDRE(T&E)/WSA  
AF/TE  
AF/PEO/TA  
AF/AQQ



OFFICE OF THE DIRECTOR OF  
DEFENSE RESEARCH AND ENGINEERING

WASHINGTON, DC 20301

Bill Gurney  
Dr. Dennis

Al, FYI  
Jim

27 JAN 1992

Honorable Charles E. Bennett  
House of Representatives  
Washington, D. C. 20515

Dear Congressman Bennett:

This is in response to your letter of January 2, 1992, to me regarding Live Fire Testing (LFT) of the C-17.

As I previously reported to you, the C-17 will be subjected to vulnerability testing with oversight by my Live Fire Test Staff. However, fully loaded aircraft will not be tested as this would be prohibitively expensive and the benefit would be small when weighed against the cost. Components and C-17 sections will be tested. The precise level of testing in terms of threat munitions and the size of the C-17 sections to be tested is still under review. We intend to conduct the analyses and component tests necessary to provide us with the information we need to assess C-17 vulnerabilities.

You have a copy of the Office of the General Counsel, Office of the Secretary of Defense, review of the issue. They have concluded that the C-17 is not subject to the requirements of section 2366. Section 2366 requires testing of the system configured for combat, not just components. Consequently, if section 2366 were applicable to the C-17, the Department would have to seek legislative relief because section 2366 permits a waiver only before a program enters full-scale engineering development. The C-17 program had already entered full-scale engineering development before section 2366 was enacted. Had a waiver been permissible, we would have waived the applicability of survivability tests of section 2366 because full-up live fire testing of complete, fully loaded C-17's would be unreasonably expensive and impractical.

Sincerely,

Charles E. Adolph  
Deputy Director,  
Defense Research and Engineering  
(Test and Evaluation)

CHARLES E. BENNETT  
MEMBER

3D DISTRICT, FLORIDA

VICE CHAIRMAN OF  
ARMED SERVICES COMMITTEE  
CHAIRMAN OF SEAPOWER SUBCOMMITTEE  
MEMBER OF RESEARCH AND  
DEVELOPMENT SUBCOMMITTEE

MERCHANT MARINE AND FISHERIES  
COMMITTEE

DEAN OF FLORIDA CONGRESSIONAL  
DELEGATION

# Congress of the United States

House of Representatives

Washington, DC 20515-0903

January 2, 1991

1992

JAMES S. PEARTREE  
ADMINISTRATIVE ASSISTANT  
M. ADAM HOLLINGSWORTH  
LEGISLATIVE ASSISTANT

SHARON H. SIEGEL  
BARBARA L. FETHEROLF  
DARLA E. SMALLWOOD  
ETHEL M. SCHISSELL  
A. LYNN MILLER  
PATRICIA McDONOUGH  
GLENDA K. LAWING  
COURTENAY MCCORMICK  
WASHINGTON OFFICE ST.

BRENDA C. DONALDSON  
DONNA M. WELDON  
EDWINNA S. GREEN  
JACKSONVILLE OFFICE ST.

The Honorable Charles E. Adolph  
Director of Defense Research and Engineering  
Room 3E1014  
The Pentagon  
Washington, D.C. 20301

*Cal Mandel*  
*17*  
*AF/TE*  
*Gen Leah*

Dear Mr. Adolph:

Thank you for responding to my October 28 letter to Mr. Yockey, Under Secretary of Defense for Acquisition, regarding C-17 live fire testing. I am pleased that you expect the C-17 to be subjected to live fire testing because the security of our men and women in uniform has been immeasurably enhanced by this testing program.

However, your letter does not address the central issue raised in my original correspondence. That is, will the C-17 be subjected to live fire testing in accordance with section 2366 of U.S.C. 10. A memorandum by Mr. Gurden Drake, of the OSD General Counsel's Office, concluded that "the C-17 is not subject to the requirements of section 2366." As you know, I disagree with Mr. Drake's finding and presented in detail my objections in my original letter to Mr. Yockey.

Your letter makes clear that a primary concern is whether it is prudent or cost effective to subject a full-up combat loaded C-17 aircraft to live fire testing. The report language that accompanied the original legislation stipulated that the conferees intended that "realistic" vulnerability and lethality tests be conducted "first at the sub-scale level."

Your letter, however, makes no commitment to test at the sub-scale or full-scale level. It makes no mention of which components will be tested, how they will be configured, or what munitions will be used. In fact, it states that, "The C-17 will be subjected to live fire



testing to the extent prudent...and [with] the expected benefit of the test weighed against the costs. The precise level of testing in terms of threat munitions and the size of the C-17 sections to be tested are still under review." This description of the testing program is open to wide interpretation, but it implies to me that your office assumes that the C-17 is not considered a covered system under section 2366. I believe that this interpretation is wrong.

Therefore, I ask that you provide me with a definitive answer to my original question -- does DoD consider the C-17 to be a covered system under the terms of section 2366, U.S.C. 10. If the answer is no, then, under the law, the Secretary of Defense must certify to the Congress that live fire testing on the C-17 would be unreasonably expensive or impractical. He must then submit a report explaining how he plans to evaluate the survivability of this aircraft and assess possible alternatives to the "realistic survivability testing" that is required under the statute.

---

I look forward to your response.

Sincerely,

A handwritten signature in black ink, appearing to read "Charles E. Bennett". The signature is stylized and cursive, with a large initial "C" and a prominent "B".

Charles E. Bennett



DIRECTOR OF DEFENSE RESEARCH AND ENGINEERING

WASHINGTON, DC 20301-3010

13 NOV 1991

Honorable Charles E. Bennett  
House of Representatives  
Washington, DC 20515

Dear Congressman Bennett:

This is in response to your letter of October 28 to Mr. Yockey, Under Secretary of Defense for Acquisition, regarding C-17 survivability testing. The purpose of this letter is to clarify the status of live fire testing of the C-17.

The C-17 will be subjected to live fire testing to the extent prudent based on the latest threat information and the expected benefit of the test weighed against the costs. It is not anticipated that a full-up combat loaded aircraft will be subjected to live fire testing. Components and C-17 sections will be tested. The precise level of testing in terms of threat munitions and the size of the C-17 sections to be tested are still under review. We intend to conduct the analyses and component tests necessary to provide us with the information we need to assess C-17 vulnerabilities.

Sincerely,

Charles E. Adolph

By Direction of the Secretary of Defense

MEMBER OF SENATE AND HOUSE OF REPRESENTATIVES  
MEMBER OF RESEARCH AND DEVELOPMENT SUBCOMMITTEE  
MEMORANDUMS AND FINANCE COMMITTEE  
DEAN OF FLORIDA CONGRESSIONAL DELEGATION

# Congress of the United States

House of Representatives

Washington, DC 20515

October 28, 1991

M. ARAN  
L. B. BROWN  
J. B. BROWN  
S. B. BROWN  
D. B. BROWN  
A. L. PATRIC  
G. L. PATRIC  
WASHINGTON  
J. L. G. GUY  
GUY  
BRENDA  
DORIS  
JACKSON

The Honorable Donald J. Yockey  
Under Secretary of Defense for Acquisition  
Room 3E1006  
The Pentagon  
Washington, D.C. 20301

Dear Mr. Yockey:

It has recently come to my attention that the Department of Defense is in the process of determining whether the C-17 aircraft is required to undergo survivability testing in accordance with section 2366 of U.S.C. 10. A memorandum by Mr. Gurden E. Drake, of the OSD General Counsel's Office, outlines the case against subjecting the C-17 to survivability testing in accordance with section 2366. In this memorandum, Mr. Drake concludes that his analysis "leads to the conclusion that the C-17 is not subject to the requirements of section 2366."

As a principal author of the original House bill language on survivability, lethality, and operational testing and also as a primary negotiator with the Senate on the final language contained in section 2366, I can assure you that it was the intent of the Congress that the C-17 be a covered system that is fully within the scope of section 2366. Therefore, I believe that the C-17 is required to be subjected to survivability testing as required in the statute.

Section 2366 states that, "a covered system may not proceed beyond low-rate initial production until realistic survivability testing of the system is completed." It then defines the term "covered system" as "a vehicle, weapon platform, or conventional weapon system (A) that includes features designed to provide some protection to users in combat; and (b) that is a major system within the meaning of that term in section 2302(5) of this title." Based on the statutory language, I agree with Mr. Drake's contention that the C-17 must meet three tests to be considered as a candidate for

vehicle, weapon platform, or conventional weapon system. Second, it must include features that are designed to provide some protection to the users in combat. Third, it must fall within the statutory definition of a major system.

Mr. Drake's memorandum concedes the last of the three tests and states that the C-17 "is clearly a major system." I agree with his conclusion.

However, he disputes that the C-17 is either a vehicle, weapon platform, or conventional weapon system and he also states that the C-17 "does not have features designed to protect the user in combat." On this latter point, Mr. Drake notes that Air Force officials have stated "that the 'protection features' on the C-17 are not unique to the C-17 but are also common on commercial aircraft."

I dispute both of these contentions. First, Mr. Drake finds that the C-17 is not a vehicle. To support his case he cites Webster's Ninth New Collegiate Dictionary and the sixth edition of Black's Law Dictionary. He concludes that "the preferred usage [of the term vehicle] seems to be land vehicles." However, according to a Joint Chiefs of Staff publication (Pub. I-02), a vehicle is defined as "a self propelled, boosted, or towed conveyance for transporting a burden on land, sea, or through the air or space." This definition makes clear that the term "vehicle" is not limited to land vehicles. In addition, the Air Force designates its B-2 bombers as "air vehicles".

He further states that, "There is no language in the reports accompanying the legislation that indicates that the committees considered a cargo aircraft to be a vehicle for the purposes of U.S.C. 10 section 2366. Given this...I conclude that the C-17...is not what the Congress intended as a vehicle within the meaning of U.S.C. 10 section 2366." As I have stated earlier, I believe that it was the intent and the sense of the Congress that the C-17 be a covered system under the scope of section 2366.

Second, contrary to Mr. Drake's assertion, the C-17 does indeed have unique features that are designed to "provide some degree of protection to users in combat." The United States Air Force Report to the 101st Congress for Fiscal Year 1991, states "The [C-17] defensive systems program responds to the need for an integrated, common architecture defensive suite that provides protection for airlift

among terrorist forces places airlift aircraft in jeopardy even in a peacetime environment. During wartime, we would expect to operate in a more threatening environment." This testimony makes clear that such defensive "protection features" are needed to help ensure both aircraft and crew survivability and would not commonly be found on commercial aircraft.

Therefore, I believe that the C-17 meets the three criteria required for a system to be considered for survivability testing under section 2366.

In a final section of his memorandum, Mr. Drake points out that the C-17 is not required to undergo survivability testing because the definition of the term "realistic survivability testing" contained in section 2366 "requires the firing of munitions 'at the system configured for combat'...it is our understanding that there are no plans to configure the C-17 for combat. Therefore, the testing requirement could never be met if the C-17 were a 'covered system'."

I think that Mr. Drake misses the point of section 2366 by selectively citing the definition of the term "realistic survivability testing." The full definition reads "testing for vulnerability of the system in combat by firing munitions likely to be encountered in combat (or munitions with a capability similar to such munitions) at the system configured for combat, with the primary emphasis on testing the vulnerability with respect to user casualties and taking into equal consideration the susceptibility to attack and combat performance of the system."

The clear intent of this language was to test the vulnerability of covered systems to munitions that would likely be encountered in combat conditions. The production model C-17 is assumed to be configured for combat because it is assumed that it will encounter combat conditions. As General Hansford T. Johnson, CINC, US Transportation Command, told the Senate Armed Services Committee in February 1990, that "The airlifter of the future will need to be more flexible, able to operate in the austere environment of short, semi-improved fields, delivering cargo directly to the battle in an increasingly complex threat environment. The C-17 is that airlifter."

I hope that my comments on the Congressional intent of U.S.C. 10 section 2366 will be helpful.

the C-17 falls within the statutory language, and that it meets all the criteria that are necessary for it to be subjected to survivability testing as required in section 2366. I would appreciate being kept up to date on the disposition of this issue.

With kindest regards,

Sincerely,

A handwritten signature in cursive script, appearing to read "Charles E. Bennett".

Charles E. Bennett



OFFICE OF THE DIRECTOR OF  
DEFENSE RESEARCH AND ENGINEERING  
WASHINGTON, DC 20301-3030

October 22, 1991

MEMORANDUM FOR ASSISTANT SECRETARY OF THE AIR FORCE (SAF/AQ)  
SUBJECT: C-17 Live Fire Test and Evaluation (LFT&E) Status

The C-17 cargo aircraft has been a candidate for Live Fire Testing since it was first placed on the OSD oversight list in 1987.

Recent discussions between various OSD offices and the Air Force have raised questions as to the applicability of the statutory requirements for LFT&E. OSD General Counsel has provided its opinion on this issue in its October 9, 1991 memorandum.

The opinion rendered by OSD General Counsel is being reviewed along with other relevant information. However, no decision has yet been made by this office to remove the C-17 from the LFT&E oversight list. We will keep you informed on this issue.

In the meantime, we are still in need of a briefing on the updated threat assessment of this program in light of the recently updated System Threat Assessment Report (STAR).



Richard R. Ledesma  
Acting Deputy Director  
(Test and Evaluation)

cc:  
DDRE, Mr. Adolph  
PEO, TAP, MG Franklin  
TWP, Mr. Kendall  
LFT, Mr. O'Bryon

21 OCT 1991

Honorable Charles E. Bennett  
House of Representatives  
Washington, DC 20515

Dear Congressman Bennett:

I am writing to you in reference to the Live Fire Testing legislation (10 USC, Para 2362 & 2366) which you helped to author a couple of years ago.

Some questions have recently arisen as to the sense of Congress on the applicability of the Air Force's C-17 cargo aircraft to the statutory requirements for Live Fire Testing (LFT).

OSD General Counsel has recently provided its opinion on the applicability of the statutory requirements to the C-17 aircraft. The opinion, which we still have under advisement, contains, in several instances, references to the "sense of Congress" in writing and passing the LFT legislation.

Since my responsibilities as Director, Live Fire Testing include the recommendation of LFT policy and to ensure that the law and the sense of Congress are carried out, I would appreciate your comments as to the sense of Congress on this matter, and in particular, with reference to the applicability of the legislation to the C-17. Thank you.

Sincerely,



James F. O'Bryon  
Director, Live Fire Testing  
Deputy Defense, Research & Engineering  
(Test and Evaluation)

cc:  
DDDRE(T&E)





DEPARTMENT OF DEFENSE  
OFFICE OF GENERAL COUNSEL  
WASHINGTON, D.C. 20301-1600

Copy to  
NUTEM 10/11  
EL

October 9, 1991

MEMORANDUM FOR DEPUTY DIRECTOR DEFENSE RESEARCH AND ENGINEERING,  
TACTICAL WARFARE PROGRAMS

SUBJECT: Survivability Testing -- C-17

This is in response to your request for my views as to whether the C-17 aircraft is subject to the survivability testing requirements of 10 U.S.C. § 2366.

Section 2366 prescribes survivability testing before a "covered system" proceeds beyond low rate initial production. Subsection (e) defines a "covered system" to mean "a vehicle, weapon platform, or conventional weapon system-

(A) that includes features designed to provide some degree of protection to users in combat; and

(B) that is a major system within the meaning of that term in section 2302(5) of this title."

Consequently, in order for the C-17 to be a covered system, subject to survivability testing, it must meet three tests. First, we must determine whether the C-17 is a "vehicle," a "weapon platform," or a "conventional weapon system." Second, it must include features designed to provide protection to the users in combat. Third, it must constitute a "major system." With respect to the third test, it is clearly a major system, and consequently I will not discuss this point further.

With respect to the first test, the C-17 clearly is not a conventional weapon system or a weapon platform. Webster's Ninth New Collegiate Dictionary defines a vehicle as "...a means of carrying or transporting something: Conveyance: as a: motor vehicle b: a piece of mechanized equipment...." Blacks Law Dictionary, Sixth Edition, defines vehicle as "that in or on which persons, goods, etc. may be carried from one place to another, especially along the ground." While these definitions are broad enough to cover an airplane such as the C-17, the preferred usage seems to be land vehicles. Consequently, in interpreting the statute one has to look at what Congress was trying to get at.

Because of the breadth of the terms "weapon system" and "weapon system platform," it is difficult to discern what the term "vehicle" adds to the equation. In this regard, it is instructive to note that the House Armed Services Committee, which initiated section 2366 as part of the National Defense Authorization Act for Fiscal Year 1987, was at the same time debating the survivability of, and the requirement for, live fire testing of the Bradley Fighting Vehicle. That may have been the catalyst for including the word vehicle in the list.

There is no language in the reports accompanying the legislation that indicates that the committees considered a cargo aircraft to be a vehicle for the purposes of 10 U.S.C. § 2366. In fact, the conference report, in referring to the provision, appears to lump all three categories into the category of "major conventional weapons system." The conferees stated at page 498 of the report accompanying the National Defense Authorization Act for Fiscal Year 1987, H. Rep. No. 1001, 99th Congress, that "the provision would require that a major conventional weapons system not proceed beyond low-rate initial production until (1) a realistic survivability or lethality test is completed...." Given this, and the absence of a reference to cargo aircraft as being the sort of vehicle the Congress intended to be subjected to survivability testing, I conclude that the C-17, an unarmed cargo aircraft that does not engage in combat, is not what the Congress intended as a vehicle within the meaning of 10 U.S.C. § 2366.

However, the analysis does not end here. Turning to the second test, the definition of a "covered system" requires that the system include features designed to protect the user in combat. It is my understanding that the C-17 does not have features designed to protect the user in combat, although some of the features would provide a degree of protection. The Air Force representatives at the meeting in your office on 26 September 1991 indicated that the "protection features" on the C-17 are not unique to the C-17 but are also common on commercial aircraft to, for example, protect from lightning strikes. If this is correct, then it appears to me that the C-17 does not meet the second part of the definition of a covered system.

Finally, the definition of the term "realistic survivability testing" indicates that the Congress did not intend to include a cargo aircraft like the C-17 within the scope of section 2366. This definition requires the firing of munitions "at the system configured for combat." First, it is our understanding that there are no plans to configure the C-17 for combat. Therefore,

the testing requirement could never be met if the C-17 were a "covered system." Second, the definition requires "testing for vulnerability of the system in combat by firing munitions likely to be encountered in combat (or munitions with a capability similar to such munitions.)" Such munitions likely would include surface to air missiles. Firing these munitions at the C-17 would destroy a very costly aircraft. I do not believe Congress intended that result, and I would therefore not read section 2366 to produce that result.

While the foregoing leads to the conclusion that the C-17 is not subject to the requirements of section 2366, it does not prohibit any testing of the C-17 that the Department determines would serve a useful purpose.



Gurden E. Drake

cf: DD (T&E)



OFFICE OF THE DIRECTOR OF  
DEFENSE RESEARCH AND ENGINEERING

WASHINGTON, DC 20301

27 OCT 1989

(T&E)

MEMORANDUM FOR DIRECTOR, TEST AND EVALUATION (SAF/AQV)

Noted by  
SAF/AQ

SUBJECT: C-17 Live Fire Test and Evaluation Strategy

The Air Force strategy for the Live Fire Test and Evaluation (LFT&E) of the C-17, as provided in your memorandum of October 26, 1989, is approved. This LFT&E strategy needs to be reflected in the next Test and Evaluation Master Plan (TEMP) update.

Approval is based upon the Air Force documenting, in both the TEMP and the Congressional Test and Evaluation Data Sheet (CDS), that the C-17, in the event of unsuccessful evasive or defensive response is vulnerable to higher order threats (23mm and above, HEI-high explosive/incendiary burst, multiple impacts) and that the Air Force considers the results of these threats to be catastrophic.

Additionally, as provided in the LFT&E Guidelines dated June 1, 1989, the Office of the Director, Live Fire Testing will review and comment upon the detailed plans for C-17 LFT&E and monitor the LFT&E program during its conduct.

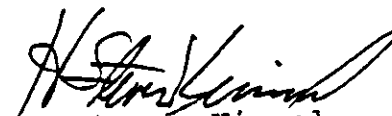
  
H. Steven Kimmel  
Acting Deputy Director  
Defense Research and Engineering  
(Test and Evaluation)



(T&E)

OFFICE OF THE DIRECTOR OF  
DEFENSE RESEARCH AND ENGINEERING

WASHINGTON, DC 20301

*MAJ Pudwill*

14 NOV 1988

MEMORANDUM FOR RECORD

SUBJECT: Meeting at C-17A Program Office on November 8, 1988

The purpose of the meeting was to discuss the C-17 program office approach and timetable for responding to the LFT letter which detailed concerns about the proposed C-17A LFT strategy. The intent was to reach closure on the C-17 strategy between LFT and the C-17 office prior to the next year's TEMP submittal and deadlines for changes to the FY91 budget. The meeting was at WPAFB, arranged by MAJ Pudwill at the request of the undersigned. In attendance at the main meeting were:

MAJ Pudwill, C-17 PEM  
MAJ Randy Davis, C-17  
Mr. Warren Tripp, C-17

COL V. Kindurys, LFT  
LT Martha Smith, C-17A  
Mr. Marty Lentz, ASD/ENSS

Prior to the main meeting, the undersigned and BG Butchko met privately (at my request) to discuss events which occurred during his briefing to OSD C-17 AOs on November 2. We expanded into the philosophy of the C-17A and its role in combat.

Following that discussion, I raised the topic of procedures that we would adhere to in the future. Specifically, I again requested a copy of the 26-view vulnerability analysis. BG Butchko stated that he had only one copy of the 5-volume study and did not want to part with it or make a xerox copy. He stated that I could have full access to the document if I would travel to the C-17 office at Wright-Patterson AFB, OH. He would provide a desk in a secure area for me to work while there. I replied that our office not having a copy would make our work unnecessarily difficult and that I prefer to have copies of the documents.

I mentioned that IDA personnel would be our agent in this matter. BG Butchko was not in favor of this claiming that the data was proprietary. I said that IDA was an FFRDC and that this should not be a problem. He insisted that I personally work with his office to avoid problems. I stated that the customary procedure is to provide documents to our office and to allow IDA personnel access to data requested through us.

BG Butchko expressed his concern at the amount of time required by his personnel to respond to our requests. He also

stated that he did not want us to go to the prime contractor and take their time as well. I assured him that I understood his management concern but that we did have a job to perform. BG Butchko had to leave for another appointment so the above items were not fully resolved. He said that he would leave the details to the discussion between the undersigned and his staff.

The main meeting started with my providing the background for some of the comments in our letter. MAJ Davis stated that this explanation was helpful since they experienced some confusion about the rationale for our comments. A discussion of the possible form of their planned response to the letter ensued. I emphasized that they should provide detailed references to tests that support their position. These references would be requested by our office.

MAJ Davis and MAJ Pudwill expressed a strong desire to cooperate with our office to reach agreement on the Live Fire Test and Evaluation (LFT&E) strategy. MAJ Pudwill stated that the primary purpose was to reach agreement prior to the submission of the Test and Evaluation Master Plan (TEMP) to OSD which is due in October 1989. I emphasized that agreement should be reached by May 1989 so that budget changes could be initiated. MAJ Davis said that he thought agreement should be reached by April.

I was provided an opportunity to read the 5-volume vulnerability study after lunch. Given the size of the volumes and the time available, I simply scanned the documents finding them to be a standard 26-view vulnerability analysis of the C-17. A more thorough examination of the documents is needed. I elected to discuss philosophy of LFT&E and how best to respond to our letter.

**ACTION ITEMS:**

1. MAJ Davis will talk with BG Butchko on the release of the vulnerability study and allowing IDA access to the information.
2. MAJ Pudwill will try to arrange a visit for me and COL Kindurys to an active MAC operation so we can gain a better appreciation of the use of the C-17.

3. I will alert IDA to travel to the C-17 office to study the documents in the event that our office is unable to acquire a copy of our own.
4. MAJ Davis will forward to the Air Staff their response to our letter NLT January 13, 1989.
5. MAJ Pudwill will provide that response to our office NLT February 3, 1989.



Albert E. Rainis  
Staff Specialist  
Live Fire Testing

cf:  
ADUSD(TWP)/NAV WARFARE & MOB  
ADDDRE(T&E)/LFT  
ADDDRE(T&E)/WSA  
SAF/AQQL



OFFICE OF THE DIRECTOR OF  
DEFENSE RESEARCH AND ENGINEERING

WASHINGTON, DC 20301

11 OCT 1988

9 (T&E)

MEMORANDUM FOR SAF/AQQL, MAJ PUDWILL

SUBJECT: C-17A Live Fire Test (LFT) -- INFORMATION MEMORANDUM

C-17A has already budgeted \$15M for LFT in FY90 which indicates a willingness to plan for LFT. However, closure on the C-17A LFT strategy is still being pursued and the C-17A LFT budget for FY91 may have to be amended. The meeting on December 13 must establish a timeline for closure on the LFT strategy which provides sufficient time to amend the C-17A FY91 budget to support LFT, if required.

As we discussed in the October 7 meeting, Director, LFT, will need some information, prior to his attending the Conventional Systems Committee (CSC) meeting on November 14. We agreed to meet at WPAFB to discuss progress on addressing our concerns. You indicated that this visit could be arranged prior to the CSC meeting. At that time, I would like to see the C-17A vulnerability assessment and have a copy sent so we can prepare for the December 13 meeting.

If we can help in any of the issues which affect LFT, please let us know.

A handwritten signature in cursive script that reads "Albert E. Rainis".

Albert E. Rainis  
Staff Specialist  
Live Fire Testing





(T&E)

OFFICE OF THE DIRECTOR OF  
DEFENSE RESEARCH AND ENGINEERING

WASHINGTON, DC 20301

14 APR 1989

K414 MEMORANDUM FOR DIRECTOR, STRATEGIC/SOF/AIRLIFT PROGRAMS, SAF/AQQ

SUBJECT: C-17A Live Fire Test (LFT) Strategy

Mike —

I am concerned about the delay in arriving at an acceptable C-17A strategy and the resultant impact upon future OSD program reviews. The information provided this office in the attached March 17 memorandum does not fully address the issues raised in our memorandum of September 21. The vulnerability analysis, cited as the basis for the C-17A LFT strategy and requested by this office in August 1988, has not been provided. References to substantiate the C-17A LFT strategy are also lacking.

The C-17A LFT strategy which limits testing to 12.7mm against the leading edge causes us to be concerned. The single munition slated for testing does not address the range of threat weapons contained in the medium threat environment specified in the C-17A System Operational Concept. Further, the leading edge of the wing may be a large contributor to the vulnerability of the C-17A but other components must be considered in the LFT strategy.

A proposed LFT strategy which addresses our previously stated concerns has been prepared by our office and can be used as the basis for substantive discussions. We suggest a meeting at the action officer level, for the week of May 1, to examine the alternative C-17A strategies to reach closure in a timely manner.

*Pete*

Charles E. Adolph  
Deputy Director  
Defense Research and Engineering  
(Test & Evaluation)

Enclosure  
AS STATED

cc:  
TWP/NWM



DEPARTMENT OF DEFENSE  
WASHINGTON HEADQUARTERS SERVICES  
PERSONNEL AND SECURITY  
1777 NORTH KENT STREET STE 12063  
ARLINGTON VA 22209-2164

HRSC/BAB

November 5, 2001

MEMORANDUM FOR EMPLOYEES

SUBJECT: Federal Employees Health Benefits (FEHB) – Open Season  
November 12 through December 10, 2001

The U.S. Office of Personnel Management (OPM) has announced that an Open Season for Health Benefits Enrollment will be conducted during the period November 12, through December 10, 2001, with changes and new enrollments to be effective January 13, 2002.

The 2002 FEHB Open Season is your opportunity to enroll in health insurance coverage if you are not currently enrolled. If you are currently enrolled, you may switch from one plan or option to another, move from self only to self and family, or make a combination of these changes. This is also your opportunity to elect to participate in Premium Conversion (PC) if participation was previously waived. You may also elect to waive participation.

If you are on a "temporary appointment" please ensure you are reviewing the correct Comparison Guide. Employees on "temporary appointments" are required to pay the employee share of the premium as well as the government share.

During this open season you can ensure that your change will be expedited so that you will most likely receive your New Carrier Identification Card before the effective date (January 13, 2002) by using the Benefits Call Center (703) 617-7382, toll free (877) 521-1923 or TDD (703) 617-0658. Counselors are available Monday through Friday from 7:30 AM to 5:00 PM EST to answer any questions you may have. Once you're in the system, press "2" for Benefits Information and then press "2" again for Benefits and Entitlements. Follow the voice prompts after pressing "1" for current HRSC Service Employee and entering your social security number and PIN. (If this is your first time using the system, your PIN is your 2-digit month and 2-digit year of birth, e.g., June 1947 is 0647.) When you hear the message "For Federal Employee Health Benefits" press "1" and follow the voice prompts to make your Open Season Election. You may also make your FEHB Open Season election on our web site at <http://persec.whs.mil/hrsc/benefits.html>, click on "Benefits Information", then click on Benefits Online.

Please note that all election forms must be received in your Administrative Office, Customer Support Operating Office (CSOO), Customer Service Unit (CSU), or the Human Resource Services Center (HRSC), AMC Building Room 2S32, 5001 Eisenhower Avenue

for the pay date of February 1, 2002 or February 7, 2002 (dependent upon your pay date) to verify that premiums for the plan you elected during Open Season are being deducted correctly.

If you make a FEHB Open Season change, you should receive your identification card from your new carrier, normally 6 to 8 weeks after the effective date of your election. If you need proof of an enrollment in a health insurance plan while awaiting the ID card, you can use your copy of the SF 2809 to provide your physician or hospital. **If you use the Benefits Call Center or the WEB your ID card should be received prior to January 13, 2002.**

Temporary Continuation of Coverage (TCC): You should be aware that if you leave Federal employment you would be eligible for TCC (unless you are separated for gross misconduct). TCC can continue your enrollment for up to 18 months. TCC is also available for up to 36 months for dependents who lose eligibility as family members under your enrollment. This includes spouses who lose coverage because of divorce and children who lose coverage because they marry or reach age 22. TCC enrollees must pay the total plan premium (without a Government contribution) plus a 2% charge for administrative expenses. There are specific time frames in which you or your dependent must enroll in TCC. Contact your HRSC Benefits Specialist for additional information.

Special attention for those of you considering retirement: Did you know that there is a 5-year requirement to meet before you can transfer your FEHB coverage into retirement? You must be enrolled in the FEHB program for 5 continuous years immediately before retirement. The requirement is based on 5 years in the FEHB program, not a particular plan. If you are interested in having FEHB coverage after retirement, you must 1) be enrolled and coverage effective in a FEHB plan before your retirement, and 2) be covered for 5 continuous years immediately before retirement. An important note is that TRICARE coverage can be included in meeting this 5-year requirement, as can coverage under a Federal spouse's FEHB enrollment. For example, if you are enrolled in TRICARE and plan to retire January 31, 2002, you can enroll in FEHB during this Open Season and meet the 5-year requirement for continued coverage. If you are planning to retire 5 years from now, you may want to consider enrolling in FEHB during this open season.

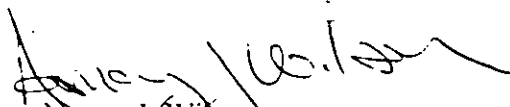

Nancy J. Wilson  
Chief, Employee Benefits and Records  
Management

---



ACQUISITION

THE DEPUTY UNDER SECRETARY OF DEFENSE  
WASHINGTON, DC 20301

DEC 28 1992 11:12/foj

MEMORANDUM FOR THE SECRETARY OF THE AIR FORCE  
ATTENTION: AIR FORCE ACQUISITION EXECUTIVE

SUBJECT: C-17 Vulnerability Program/Live Fire Testing (LFT)

I have reviewed the Air Force approach for assessing the vulnerability and LFT of the C-17 (TAB A). I concur with the approach subject to certain changes of which the following are the most significant:

- Final testing being done on C-17 production representative wings. Conclusions on vulnerability and fixes can only be derived from testing on a C-17 wing. This does not preclude the Air Force from testing concepts on another wing type.
- After completion of lower caliber projectile test, Air Force and OUSD(A) consider extending tests to 20 and 23mm. These higher calibers, although less likely to be encountered by the C-17, provide valuable insight into fuel tank hydraulic ram effect.
- Limited specific analysis is required for which testing is not cost-effective. There are potential vulnerabilities for which analysis serves in lieu of testing, so as to satisfy the FY93 Authorization Act, which mandated the provisions of the LFT law to the C-17.

TAB B provides the details of the changes in line-in/out manner. TAB C is a clean copy of TAB B.

Please provide an outline of the implementation plan and draft waiver language required by P. L. 102-484, section 132. (c) within 30 days and a detailed implementation plan within 90 days.

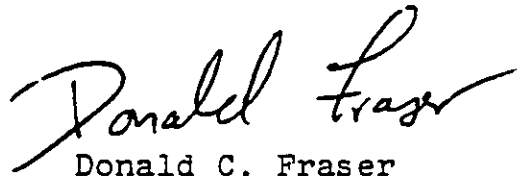
  
Donald C. Fraser

Attachments