

THIS FILE IS MADE AVAILABLE THROUGH THE DECLASSIFICATION EFFORTS AND RESEARCH OF:

# THE BLACK VAULT

THE BLACK VAULT IS THE LARGEST ONLINE FREEDOM OF INFORMATION ACT / GOVERNMENT RECORD CLEARING HOUSE IN THE WORLD. THE RESEARCH EFFORTS HERE ARE RESPONSIBLE FOR THE DECLASSIFICATION OF THOUSANDS OF DOCUMENTS THROUGHOUT THE U.S. GOVERNMENT, AND ALL CAN BE DOWNLOADED BY VISITING:

[HTTP://WWW.BLACKVAULT.COM](http://www.blackvault.com)

YOU ARE ENCOURAGED TO FORWARD THIS DOCUMENT TO YOUR FRIENDS, BUT PLEASE KEEP THIS IDENTIFYING IMAGE AT THE TOP OF THE .PDF SO OTHERS CAN DOWNLOAD MORE!

WSEG  
FILE COPY

~~TOP SECRET~~ Cop 50 of 50 copies  
SPECIAL HANDLING REQUIRED each of 370 pages

LIMITED DISTRIBUTION

Dr. Janicik  
Mrs. Jonas  
Mr. Wainstein  
14 August 1964

UNCLASSIFIED 081 2 2 836

RECORDED 78 OCT 1964  
DATE AUTHORITY JCS (87-F-21)(A)  
DECLAS ON: OADR

LOANED  
RETURN TO WSEG  
RECORDS FILE SECTION

LOANED

THIRD DRAFT  
ENCLOSURE **RETIREMENT COPY**

HISTORICAL ANALYSIS OF COMMAND AND CONTROL ACTIONS  
IN THE 1962 CUBAN CRISIS  
C&C Internal Memorandum No. 40

THIS DOCUMENT AS A WHOLE IS CLASSIFIED TOP SECRET.  
INDIVIDUAL PORTIONS AND ATTACHMENTS HERETO CARRY  
THEIR APPROPRIATE CLASSIFICATION.

INVENTORY  
IN JANUARY 72

MAR 5 1973

GROUP 1

EXCLUDED FROM AUTOMATIC  
DOWNGRADING AND DECLASSIFICATION

INVENTORY JAN 20 1972

**RETIREMENT COPY**

This material contains information affecting the national defense of the United States within the meaning of the Espionage Laws (Title 18, U.S.C. sections 793 and 794), the transmission or revelation of which in any manner to an unauthorized person is prohibited by law.

Reproduction of this document in whole or in part is prohibited except with permission of the issuing office. It will not be removed from the WSEG area in the Pentagon without approval of the Director.

Return this document to TS/LD Section, Room 1D847, PERSONALLY, or call 77313 for pickup. Do not release to Messengers, Area Control Clerks, or anyone else. Make sure you obtain your receipt upon return of this document.

80 FOI 997 DOC 13  
~~TOP SECRET~~ 46 81 295142  
Log No. TS-64-15873

OASD(PA) DFOISR  
TOP SECRET CONTROL  
Copy No. 2-6  
Case No. 80-FOI-997  
T.S. No. 83-75-92  
Document No. 13

ARMY

93

~~TOP SECRET~~

~~TOP SECRET~~

FOREWORD

This enclosure is part of a study of command control processes involved in the Cuban crisis of October 1962. The scope of the entire study is as follows:

- Basic Paper - National Military Command and Control in the Cuban Missile Crisis of 1962.
- Enclosure A - Historical Analysis of Command and Control Actions in the 1962 Cuban Crisis.
- Enclosure B - Procedural Analysis of J-3 Command and Control Operations during the Cuban Crisis, October 1962.
- Enclosure C - Functional Analysis of Command and Control Information Flow in the Joint Staff during the 1962 Cuban Crisis.
- Enclosure D - Analysis of Command and Control in the Service War Rooms in Support of Joint Staff Operations during the 1962 Cuban Crisis.

~~TOP SECRET~~

- 11 -

~~TOP SECRET~~

TOP SECRET

~~TOP SECRET~~

ENCLOSURE A

C&C INTERNAL MEMORANDUM NO. 40

HISTORICAL ANALYSIS OF COMMAND AND CONTROL ACTIONS  
IN THE 1962 CUBAN CRISIS

TABLE OF CONTENTS

	<u>Page No.</u>
PREFACE	1
PURPOSE	1
SCOPE	2
METHOD	2
DATA SOURCES	3
LIMITATIONS	4
OBSERVATIONS OF SIGNIFICANCE TO COMMAND AND CONTROL	5
PRECRISIS POLICY AND PLANNING DEVELOPMENTS	5
THE U.S. BASIC DECISION	7
COORDINATION WITH OVERSEAS UNIFIED COMMANDS AND ALLIES	9
IMPLEMENTING THE MILITARY COURSE OF ACTION	12
QUARANTINE OPERATIONS	16
CONTINGENCY PLANNING DURING THE CRISIS	19
TERMINATION OF THE CRISIS	24
DISCUSSION	26
I. INTRODUCTION: PRECRISIS U.S. POLICY TOWARD CUBA	26
THE SOVIET BUILDUP IN CUBA	26
ATTEMPTING TO IMPLEMENT AMERICAN POLICY	28
CUBA AND BERLIN	34
LATIN AMERICAN STATES AND U.S.-CUBAN POLICY	37
II. PRECRISIS MILITARY CONTINGENCY PLANNING	43
GENERAL CHARACTERISTICS OF THE CONTINGENCY PLANNING	43
ORIGIN OF THE CUBAN CONTINGENCY PLANS	44
BIFURCATION OF THE PLANNING	49

TOP SECRET

- 111 -

~~TOP SECRET~~

~~TOP SECRET~~

TOP SECRET

TABLE OF CONTENTS (Continued)

	<u>Page No.</u>
INTRODUCTION OF AIR-STRIKE CONTINGENCY PLANNING	54
QUANTANAMO REINFORCEMENT PLANNING	61
BLOCKADE PLANNING	65
REAPPRAISALS OF CONTINGENCY PLANNING	67
PLANNED U.S. MILITARY CONTINGENCY POSTURE ON THE EVE OF THE CRISIS	69
SUMMARY OBSERVATIONS	75
III. THE U.S. BASIC DECISION	80
BACKGROUND CONSIDERATIONS	80
THE DECISION-MAKING PROCESS	82
THE COURSE OF ACTION ADOPTED	86
IV. POLICY COORDINATION: OVERSEAS UNIFIED COMMANDS AND ALLIED POWERS	91
THE STRATEGIC CONTEXT	91
COORDINATION WITH NATO	95
COORDINATION WITH LATIN AMERICA	107
SUMMARY OBSERVATIONS	128
V. IMPLEMENTING THE MILITARY COURSE OF ACTION: THE FIRST PHASE	135
GENERAL PATTERN OF THE MILITARY MOVES	135
READYING AND DEPLOYMENT OF CONTINGENCY FORCES	136
INTENSIFYING GENERAL WAR PREPARATIONS	175
SUMMARY OBSERVATIONS	181
VI. THE NAVAL QUARANTINE	187
PLANNING AND ORGANIZING FOR THE QUARANTINE	188
ALERTING THE QUARANTINE FORCE	193
CONCEPT OF OPERATIONS AND RULES OF ENGAGEMENT	196
COMPOSITION OF THE PRINCIPAL QUARANTINE TASK FORCE (TF 136)	202
THE FIRST PRESIDENTIAL PRONOUNCEMENT	206
REVISED COMMAND PROCEDURES	208
THE SECOND PRESIDENTIAL PRONOUNCEMENT	210

TOP SECRET

- iv -

~~TOP SECRET~~

~~TOP SECRET~~

TOP SECRET

TABLE OF CONTENTS (Continued)

	<u>Page No.</u>
INITIAL INTERCEPTS: MODIFICATION OF TRADITIONAL COMMAND ARRANGEMENTS	212
INTEGRATION OF POLITICAL AND OPERATIONAL REQUIREMENTS	222
LATIN AMERICAN PARTICIPATION IN THE QUARANTINE	233
USE OF THE PANAMA CANAL TO SUPPORT ENFORCEMENT OF THE QUARANTINE	241
THE ABORTIVE PLAN FOR AN AIR QUARANTINE	243
THE ROLE OF THE TF 136 IN VERIFYING WITHDRAWAL OF SOVIET MISSILES	247
SUMMARY OBSERVATIONS	254
VII. ADJUSTING CONTINGENCY PLANS TO CRISIS REQUIREMENTS	263
THE CUBAN CONTINGENCY PLANS IN RELATION TO THE CRISIS SITUATION	263
SETTLING UPON AND APPROVING BASIC PLANS	265
THE J-3 CUBAN PLANNERS	273
CONSOLIDATING THE COMMAND STRUCTURE	278
LANTCOM HEADQUARTERS STAFF ORGANIZATION	290
REFRACTING THE AIR-STRIKE PLAN INTO DISCRETE OPTIONS	298
EXPANDING AND FILLING IN INVASION PLANS	312
ESTABLISHING REACTION TIMES	320
PROVIDING FOR ADEQUATE FORCE LEVELS	330
SUMMARY OBSERVATIONS	338
VIII. TERMINATION OF THE CRISIS	346
POLITICAL RESOLUTION OF THE CRISIS	347
MILITARY ADJUSTMENT TO THE POLITICAL SETTLEMENT	356
DISMANTLING THE MILITARY BUILD-UP	358

FIGURES

FIGURE 1 - COMMAND ARRANGEMENTS ENVISAGED FOR QUARANTINE FORCE OPERATIONS DURING PLANNING AND ALERTING PHASE, 15-23 OCTOBER, 1962	221
---	-----

TOP SECRET

- v -

~~TOP SECRET~~

~~TOP SECRET~~

TOP SECRET

<u>FIGURES (Continued)</u>		<u>Page No.</u>
FIGURE 2 -	COMMAND ARRANGEMENTS UTILIZED IN DECISION CONCERNING INTERCEPT OF KIMOYSK, 24 OCTOBER 1962	223
FIGURE 3 -	COMMAND ARRANGEMENTS UTILIZED IN DECISION CONCERNING INTERCEPT OF MARCUA, 25-26 OCTOBER 1962	224
FIGURE 4 -	COMMAND RELATIONS DURING PLANNING FOR CINCLANT OPLANS 312/314/316	291
FIGURE 5 -	COMMAND RELATIONS DURING IMPLEMENTATION OF CINCLANT OPLAN 312-62	292
FIGURE 6 -	COMMAND RELATIONS DURING IMPLEMENTATION OF THE ASSAULT PHASE OF OPLANS 314/316	293
FIGURE 7 -	COMMAND RELATIONS DURING IMPLEMENTATION OF THE POST-ASSAULT PHASE OF OPLANS 314/316	294

TOP SECRET

- vi -

~~TOP SECRET~~

TOP SECRET

~~TOP SECRET~~

PREFACE

1. The historical analysis in the present paper is part of a larger study of national military command and control during the Cuban Crisis of 1962 (see "FOREWORD" section, p. 11). It addresses itself to the substance of command and control experience that shaped the U.S. response, concentrating on specific actions, their circumstances, and their consequences.

PURPOSE

2. The purpose of the historical analysis, as indeed of the entire study, is to assist the Joint Staff by providing an empirical basis for improving national military command and control capability to deal with crises. It is intended as a case study to demonstrate the actual structure and processes of command, and control attending a recent real crisis of major proportions.

3. The central objective is to identify significant command and control phenomena, examine the context in which they occur, isolate the critical variables involved, and determine their implications regarding the dynamics of the national military command and control system then in effect. To this end, it seeks first to describe the command and control environment by defining the nature and unique characteristics of the crisis situation and reconstructing the main currents of crisis events. Secondly, it seeks to expose the anatomy of the command and control mechanism in terms of how it coped with particular crisis problems. Throughout, the emphasis is on discrete acts and explicit circumstances.

4. It is expressly not the purpose of this analysis to pass judgment on the intrinsic merit of actions taken at any level

TOP SECRET

~~TOP SECRET~~



~~TOP SECRET~~

TOP SECRET

DATA SOURCES

7. All available sources of information potentially relevant to the inquiry -- from official to journalistic, from formal documentary records to informal testimony based on personal recollections -- have been enlisted and utilized. However, all of the pertinent sources known to exist have not been made available. Therefore, a lacuna in the research should be noted at the outset. Access to some of the primary sources of intelligence and reconnaissance data, which had a key role in decision making, was denied on grounds of security sensitivity, as were also the records of proceedings in the meetings of the Joint Chiefs of Staff and the sessions of the Executive Committee of the National Security Council. A considerable amount of such information, though, is reflected directly in secondary official sources, or can be reliably inferred from collateral and derivative documentary indications.

8. The principal sources from which the bulk of the data is drawn are the classified official records of various elements of the Operations Directorate of the Joint Staff, especially the voluminous working files used by the Joint Battle Staff that were accumulated in the Current Actions Center of the NMCC. These are primary data in the most literal sense. They consist of messages, memoranda, and sundry other documents that represent most of the contemporary means by which command and control was actually articulated at the time. Contained among them are also much of the background considerations and immediate antecedents from which specific actions stemmed, as well as the consequences of those actions. The whole constitutes perhaps the best single source extant that approaches full coverage of what happened in the crisis.

9. Since the research phase was undertaken well before the crisis was over, many members of the J-3 staff, and others

TOP SECRET

- 3 -

~~TOP SECRET~~

~~TOP SECRET~~

TOP SECRET

elsewhere in the JCS organization, who participated in the command and control activities described were interviewed while their recollection of events was still fresh. From them were elicited many important details not reflected in the formal record.

10. In addition, through the cooperation of the Services, much valuable material was made available that cast light on otherwise obscure areas. Particular mention should be made of the original logs, journals, and other documents provided by the Army War Room, CNO Flag Plot, and the Air Force Command Post. Although advantage was taken of unclassified official information that had been made public, most of the published open sources offered little new information and were used sparingly.

#### LIMITATIONS

11. Besides the restrictions imposed on access to certain classes of recorded data already noted, another limitation is the fact that some of the data most crucial to an understanding of what happened are irretrievable. Much of the command and control activity was conducted via communication means that leave no record. [The evidence suggests that direct secure voice channels, such as KY-9, were widely used.] These conversations were exclusive between the immediate individuals involved and no one else was privy to what transpired, unless one of the principals divulged it to his staff or a subsequent reference to the conversation appeared in a log or other document. There is reason to believe that some of the more formal communications that by their nature leave a hard-copy record, such as messages and memoranda, were post facto official confirmations of something conveyed earlier telephonically. An analogous research constraint exists with regard to personal contacts. As a result of these data limitations not every aspect of the analysis could be fully developed.

TOP SECRET

- 4 -

~~TOP SECRET~~

~~TOP SECRET~~

TOP SECRET

OBSERVATIONS OF SIGNIFICANCE TO COMMAND AND CONTROL<sup>1</sup>

PRECRISIS POLICY AND PLANNING DEVELOPMENTS

12. Before the crisis, U.S. intelligence sensing was aware of the Soviet-sponsored military buildup in Cuba, but intelligence estimates did not expect it to include strategic offensive weapons systems. (Par. 80-83, 202, 203)

13. Intelligence evaluations and policy interpretations saw Cuban military developments in terms of their political implications, as jeopardizing the stability of Latin America -- not as a potential military threat directly to the U.S. itself. (Par. 112-125, 203, 204, 206, 207)

14. The U.S. precrisis policy response to the military developments in Cuba evolved gradually on an ad hoc basis. It took the form of indirect diplomatic and economic countermeasures. The policy had little success, and Allies tended to be critical of it. (Par. 82-126 passim)

15. [Military contingency planning for Cuba was undertaken long before the crisis, but its origins were independent of the main Cuban military buildup of late summer 1962. It had been initiated by Presidential directive immediately following and as a reaction to the Bay of Pigs experience of April 1961.] (Par. 132-140, 190)

16. [Contingency planning started from a single sharp focus as a straightforward invasion plan, but because of continuous national political requirements to reduce reaction times, progressively multiplied until by the eve of the crisis a "family" of plans was under " ] (Par. 127-130, 133, 141-187 passim, 191-193)

<sup>1</sup>Indicated within parentheses following each observation are references, by paragraph number, to appropriate portions of the DISCUSSION section of this enclosure that substantiate and amplify the statements made.

TOP SECRET

- 5 -

~~TOP SECRET~~

~~TOP SECRET~~

TOP SECRET

17. All of the precrisis planning was oriented to a simple unequivocal contingency situation. It assumed a localized limited-war confrontation involving the U.S. and Cuba alone, in which vital U.S. interests would not be at stake, where the motivation for military action would be essentially preemptive, and in which the tactical initiative was a U.S. prerogative. The Soviet factor did not figure militarily in the determining assumptions.] (Par. 129-137, 167-186, 195, 196)

18. The predominant influences governing contingency planning were the U.S. attitude toward Cuba's internal political system, which was never articulated in terms of firm policy objectives, and the local military circumstances of Cuban defense capability [in the event the U.S. undertook to change that system by force.] (Par. 132, 134, 161, 163, 167, 168, 173-177)

19. The impetus for most of the significant planning developments came from outside the military establishment. In each instance the national political authorities, usually the President or Secretary of Defense personally, were the prime movers who expressly directed that particular planning actions be accomplished. The characteristic process was for military objectives, force levels, the operational concept, and in some cases even the basic outline plan, to be determined in relatively explicit terms at the political level, then conveyed as instructions to the military establishment through the JCS. On occasion, political authorities stipulated specific operational provisions to be incorporated into the plans. (Par. 132-138, 141, 151-153, 167, 168, 174)

20. Most of the substantive planning was actually performed at the LANTCOM staff level and by the Service commands designated to become LANTCOM Service component commands. The Services themselves, although not in the direct chain of command, contributed

TOP SECRET

- 6 -

~~TOP SECRET~~

~~TOP SECRET~~

TOP SECRET

importantly to the content of the plans. The JCS had largely an intermediary, and somewhat procedural, role between planning principals, i.e., as agent between those who levied planning requirements and those who fulfilled them. (Par. 139-141, 151-156, 161, 164, 198)

21. [Precrisis military contingency planning, in structure and functioning, was not tightly systematic. The pattern of command and control processes was correspondingly variable. As a result, the complex of incomplete and overlapping plans, rather than being a product of comprehensive programmed development, emerged piecemeal without benefit of a common overview or master design to lend focus and direction to their evolution.] (Par. 199, 200)

#### THE U.S. BASIC DECISION

22. The precipitate onset of the crisis, and its unanticipated character, caught the U.S. by surprise. General war implications were inherent from the start. Covert discovery of the presence of Soviet offensive missiles in Cuba had revealed a suddenly materialized strategic confrontation of the first order directly with the USSR, in which vital U.S. interests were threatened. The crisis situation at hand was quite different from the abstract model of a Cuban contingency such as had been contemplated in plans. (Par. 202-205)

23. Because of the unexpected nature, gravity, and imminence of the threat, an immediate U.S. national response had to be devised on an ad hoc and short-term basis. The earlier broad policy objectives vis-a-vis Cuba were abruptly abandoned and the primary U.S. concern became limited to a return to the status quo ante missiles. (Par. 204, 207-212)

24. Two cardinal considerations shaped the formulation of the U.S. decision: the urgent need to deal with the threat before the missiles became fully operational; and fear that the situation

TOP SECRET

- 7 -

~~TOP SECRET~~

~~TOP SECRET~~

TOP SECRET

[would escalate to a Soviet-U.S. nuclear exchange. Both the speed, and type of response were therefore crucial.] (Par. 208-213)

25. The decision-making process was highly centralized. It was taken out of the usual institutional channels as soon as the significance of the photographic evidence was recognized, and put into the hands of specific personalities at the very apex of national authority. The focus was the Executive Office, with the President immersed in every step of the process. Those directly involved in the decision-making group advising the President numbered very few and were almost exclusively civilian officials. The nucleus eventually narrowed to about eight individuals who were constituted into an Executive Committee of the NSC, the sole military member of which was the Chairman, JCS. (Par. 201, 206, 207, 213, 217)

26. The JCS itself, as a corporate body, had neither a direct nor central role in formulating the basic national decision. Only the Chairman participated in the NSC Executive Committee's deliberations. The Joint Staff, in the institutional sense, generated no formal staffed inputs designed to structure or influence the choice of alternatives. (Par. 206, 213, 217 and passim)

27. The basic national decision on the U.S. response began to emerge on 18 October, four days after the initial evidence of the crisis situation was acquired. Within two days, by the morning of 20 October, the response options had been weighed and the decision had crystallized to the extent of a consensus being reached by the Executive Committee of the NSC. The proposed course of action agreed upon was tentatively adopted by the President on the afternoon of the same day (20 October), and as implementing preparations got under way, the U.S. was rapidly committed de facto to the choice made. The commitment became formal two days later on the

TOP SECRET

- 6 -

~~TOP SECRET~~

~~TOP SECRET~~

TOP SECRET

evening of 22 October, with the President's public disclosure of U.S. intentions. One week had elapsed between the time the issue first came to the attention of the national decision authority and the time when the course of action decided upon as the U.S. response went into effect. (Par. 213, 217, 221)

28. The basic national decision was, in essence, open-ended, namely, to employ minimum force initially yet be in a position to raise the scale to any level that circumstances might require. In effect, this concept amounted to responding in graduated stages, with the first course of action (imposition of the naval quarantine) but one step in a potential series of increasingly forceful measures. Within the framework of the basic decision, successive moves were to be contingent upon Soviet reaction to the first. Each subsequent decision juncture would be dealt with as it arose. (Par. 209-215)

29. The rationale underlying the open-ended decision to adjust progressively the U.S. response was that the Soviets would be forced thereby into a reactive role, with the burden of choice on them. They could either elect to disengage early at relatively little cost or, alternatively, risk allowing the confrontation to escalate to unknown proportions. (Par. 209-219, 223-231 passim)

COORDINATION WITH OVERSEAS UNIFIED COMMANDS AND ALLIES

30. Because of the need for secrecy and speed (in order to spring the U.S. response as a surprise before the missiles become operational), the basic national decision was arrived at and the opening course of action planned and launched unilaterally without prior consultation with Allies. For similar reasons, the overseas Unified Commanders were not formally apprised nor consulted until shortly before the decision was implemented. (Par. 232, 237, 287, 358)

TOP SECRET

- 9 -

~~TOP SECRET~~

~~TOP SECRET~~

TOP SECRET

31. It was nevertheless imperative to coordinate with the overseas CINCs, particularly with those in areas potentially vulnerable to local Soviet countermoves. It was equally important to gain Allied political and military support in order to present a common global posture that would deter the USSR from risking escalation of the crisis. (Par. 223-230, 241, 349-351)

32. USCINCEUR and CINCARIB, the overseas Unified Commanders most immediately concerned, were especially hampered by the strategic requirement for surprise. Though the U.S. for once enjoyed the advantage of holding the initiative, the JCS were not authorized to alert and inform them of the developing situation in advance. Last-minute notification thus imposed the added handicap of little time available for planning and operational preparations in anticipation of possible repercussions in their areas. Besides the direct effect on readiness of assigned U.S. forces, it precluded timely military coordination with friendly forces of host countries. (Par. 241-246, 248-253, 292-299, 359)

33. In the case of CINCEUR, the constraints and obligations implicit in the existing U.S.-NATO relationship posed fundamental command and control dilemmas. On the political side, a certain degree of policy coordination was accomplished through the ad hoc means of the President personally communicating with key Allied leaders, and by a personal emissary of the President being sent to the North Atlantic Council.

On the military side, however, a major strategic problem was to coordinate NATO-committed U.S. forces in Europe with the remainder of U.S. national forces elsewhere in connection with a contingency that geographically fell outside the sphere

TOP SECRET

- 10 -

~~TOP SECRET~~



TOP SECRET

~~TOP SECRET~~

[of primary alliance responsibility and interest. The problem was further compounded by the dual command role of the CINC concerned, who was both USCINCEUR and SACEUR.] (Par. 250-255, 265-283, 360)

34. [Over and above policy differences, specific technicalities arising from the NATO context created a special problem in relation to defense readiness.

[REDACTED]

(Par. 248-260)

35. [Somewhat analogous technicalities in coordinating defense readiness were encountered between U S forces and PCK forces in the context of the United Nations Command, Korea, as well as between CONAD forces and their Canadian counterpart in the context of NORAD.] (Par. 261-264)

36. In the case of CINCARIB, one of the chief coordination problems revolved around the limited CARIBCOM capabilities in relation to the extent of assistance that might be required by Latin American governments to suppress any Communist-inspired internal uprisings in support of Cuba. It was aggravated by the fact that the residual force resources of CINCSTRIKE severely restricted the augmentation available. Another coordination problem attended implementing the U.S. policy objective of actual Latin American military participation in operations against Cuba. On both scores, complex politico-military arrangements had to be negotiated quickly, with each country involved having to be dealt with on an individual national basis. (Par. 284-347, 350)

TOP SECRET

- 11 -

~~TOP SECRET~~

TOP SECRET

~~TOP SECRET~~

37. [With respect to policy coordination, formal Allied political support of the U.S. position in the crisis was achieved when all of the Allied governments declared their official backing.] In Latin America some military support was also obtained. But the NATO powers, because of standing attitudes on the Cuban issue and differing perceptions of the crisis threat, gave little military support to the overall deterrent posture. Of a lesser order, even coordination of U.S. military operational activities vis-a-vis Allies was conditioned by local policy reservations. (Par. 265-283, 284-290, 354-356)

38. [Thus, a major constraint circumscribing the range and of national command and control abroad was the critical interrelationship between U.S.-oriented military considerations and prevailing foreign political factors. A clearly demonstrated concomitant was that these political variables tended to slow down the military command and control process.]

IMPLEMENTING THE MILITARY COURSE OF ACTION

39. Because of the nature of the crisis situation and the U.S. decision in response to it, [there were simultaneously four military operational dimensions to the crises. Besides the naval quarantine, which was the only operation (other than surveillance and reconnaissance activities) that was actually carried out, these were: preparation for defense of territorial CONUS, achieving general-war posture (including generation of SIOP forces), and readiness to implement the Cuban contingency plans.] The structure and processes of military command and control were distinct for each and individually complex in their own right. The problem of keeping them properly synchronized with one another and, together, all in phase with political developments, exercised the total politico-military command and control system, from the White House to the forces in the field. (Par. 369-375, 511-512)

TOP SECRET

- 12 -

~~TOP SECRET~~

~~TOP SECRET~~

TOP SECRET

40. The covert discovery of the missiles on 14 October had afforded the U.S. strategic warning of eight days but from the military operational point of view it was nullified by the political necessity of maintaining secrecy in order to spring the U.S. response as a surprise on 22 October. (Par. 370-510, passim, 513)

41. The strategic warning did not confer an advantage on the invasion assault forces, who constituted overwhelmingly the largest proportion of forces affected. Although they were the ones who most needed advance warning, in view of the ponderous marshalling and staging necessary, they could least benefit from it, because the magnitude of activity would tip the U.S. hand and might be undesirably provocative. (Par. 454-492, 515-518)

42. Optimum mobilization had to give way in favor of projecting a national image of deliberate restraint balanced by firm determination. Ultimately, it was hoped, the purpose of military operational preparations would be symbolic as an earnest of U.S. intentions in the larger dialogue with the Soviet Union. (Par. 431, 519, 520)

43. However, the CONUS-based CINCs, i.e., LANT, SAC, COMAD, although not officially informed by the JCS of what the U.S. course of action would be until 21 October, were alerted to coming events early enough by the Services to permit staff preparations in anticipation of operational requirements, so that all were engaged in readiness activities by 17 October. USAF forces, especially, exploited to advantage the grace period; actual operational air deployments began on 17 October, well before a national decision had been reached. (Par. 378-510, passim, 514)

TOP SECRET

- 13 -

~~TOP SECRET~~

~~TOP SECRET~~

TOP SECRET

44. [Fear of escalation created basic command and control dilemmas bearing directly upon operational preparations. The effect was at once to expand and narrow the scope, type, and degree of combat readiness required and permitted, because measures to deal with the local contingency inescapably impinged upon general-war issues. On the one hand, the Soviet military presence in Cuba made the consequences of otherwise conventional limited-war invasion or air attack unknown, and U.S. strategic posture for general war had to be prepared accordingly.]

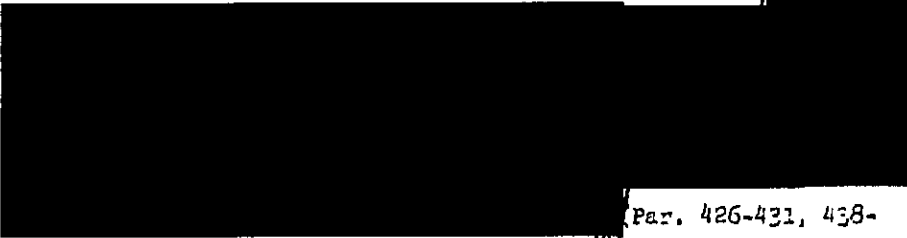

AI

(Par. 426-431, 438-

451, 492, 494-510, 517-522)

45. [Rules of engagement, in terms of concrete application in specific circumstances, also constituted a major operational command and control problem area. There was a noticeable reluctance on the part of the JCS to make precommitting decisions defining the criteria for initiating, and the parameters for conducting, combat operations not explicitly covered in plans, especially regarding the critical issue of tactical response to hostile acts of the enemy. The guidance provided by the JCS that ostensibly was to govern U.S. reaction in the hypothetical exigency in question was sometimes so qualified as to be self-contradicting. Whatever handicapping effect this may have had operationally for the tactical forces involved, the resulting ambiguity tended to enhance centralized control at the highest level, for it insured that field commanders would in each instance have to seek authorization before taking a potentially serious move.] (Par. 392-396, 426-429, 523)

TOP SECRET

- 14 -

~~TOP SECRET~~

~~TOP SECRET~~

TOP SECRET

46. Current operational activity connected with readiness preparations under way accounted for many urgent substantive problems to which the military command and control system had to address itself. Limitations in available resources, particularly forces, lift capability (land, sea, and air), and base facilities, required intensive re-scheduling of movements and revising of staging plans, which amounted to a complex secondary order of technical decision junctures. Monitoring the response of all the forces so affected in order to keep abreast of the status of readiness as a whole, posed extensive information requirements. In both respects, the burden of attendant command and control functions fell on the Joint Staff, specifically on J-3, as the focal common denominator embracing the various Service interests and command echelons involved. (Par. 378, 379, 416-425, 466, 467, 481, 483-490)

47. When operational conflicts arose between CINCs, as in the case of competing demands of LAITCOM contingency air deployments against those of COMAD and SAC, coordination was effected at the JCS level. The degree of detail in which some of these problems had to be approached before they could be resolved by the JCS imposed correspondingly intensive ad hoc information and staffing support requirements on J-3. (Par. 308-309 passim)

48. Discrepancies between operational needs of a CINC and logistic resources and capabilities of a Service similarly had to be reconciled at the JCS level. Sometimes these required that the JCS render explicit rulings on the technical and tactical details of operational deployment for the CINC concerned. [In the process, because an appropriate ready data base was not normally maintained within the OJCS, J-3 had to improvise information retrieval and perform technical staffing to support the JCS disposition of the problem.] (Par. 411-425, 466-489)

TOP SECRET

- 15 -

~~TOP SECRET~~

~~TOP SECRET~~

TOP SECRET

49. After initial operational readiness was achieved, maintaining it without degradation over a sustained period, while at the same time bringing the posture to the required full state of preparedness, continued to preoccupy the military command and control system. [Maximum readiness of total assault forces was not reached until the latter part of November.] In the interim, what adjustments were necessary to avoid undue force attrition, to rectify deficiencies, or to refine and improve special facets of operational readiness tended to be accomplished at a more decentralized level. During this second phase, the perspective of the JCS role gradually reverted to broader overall functions of conveying requirements, review, and approval. (Par. 450-453, 492, 502, 507-509)

#### QUARANTINE OPERATIONS

50. The limited, selective naval Quarantine that was actually implemented as the initial course of action in the U.S. response was essentially a form of military demonstration in support of diplomatic measures. Nevertheless, it constituted the most critical area of command and control of the entire crisis.

51. Since subsequent decisions on other political and military moves would be dependent in large measure upon Soviet reaction to the Quarantine, it was pivotal to the overall national strategy for dealing with the crisis. Quarantine operations accordingly received the intensive attention of national decision makers, and command and control related to them was subordinated to considerations other than military operational criteria alone. (Par. 524, 530, 531, 539-545, 669-673)

TOP SECRET

- 16 -

~~TOP SECRET~~

~~TOP SECRET~~

TOP SECRET

52. Fundamental ad hoc adjustments to the established institutional command and control system were occasioned early in the crisis by the designation of the CNO to serve as JCS representative for the Quarantine. The effect was to shift the focus of quarantine command and control from the Joint Staff to OPNAV, thereby precipitating a series of secondary changes in staff organization and procedures. CNO Flag Plot assumed many of the functions connected with the Quarantine that normally would have been the responsibility of the Joint Battle Staff. This necessitated the creation within J-3 of a special "Blockade Group" to maintain liaison with OPNAV and keep the Chairman, JCS, the Director, Joint Staff, and other elements of OJCS informed on current developments in the Quarantine. (Par. 533-541, 565-574, 675-679)

53. In practice there were also significant procedural departures in the functioning of the Quarantine command and control system beyond those implied in the ad hoc modifications to its structure. At crucial junctures, the entire system was radically compressed; national decision makers preempted tactical command, bypassing intermediary command links, and would themselves exercise direct operational control over the immediate actions of Quarantine task force units. (Par. 680-684)

54. There were three instances of such real-time command and control of the details of tactical operations from the seat of government. The first was in connection with the principal targets for interception (Soviet Poltava-class ships) reversing course - when the Secretary of Defense, the CNO, and their

TOP SECRET

- 17 -

~~TOP SECRET~~

E

~~TOP SECRET~~

TOP SECRET

[Deputies relayed explicit White House instructions via secure voice channels directly to commanders of ships assigned to carry out the intercepts.] (Par. 554-577, 591)

55. [A second instance of similar real-time national command and control was in connection with Soviet tankers, especially the BUCHAREST - when the CNO and his Executive conveyed White House guidance directly to quarantine task force elements.] (Par. 578-583)

56. A [third instance was in connection with non-Bloc vessels, particularly in the case of stopping and boarding the Soviet-chartered Lebanese freighter MARUCLA - when decisions governing the moment-by-moment operational moves of the specific quarantine ships involved were made by the Secretary of Defense and his Deputy acting on specific instructions of the President then communicated directly to the individual ship commander concerned.] (Par. 584-588)

57. An unanticipated additional mission for the quarantine task force was verification of Soviet withdrawal of its deployed missiles. The terms of the bilateral U.S.-Soviet inspection arrangements that were negotiated on the political level, however, covered in comprehensive detail the operational procedures to be followed. Command and control processes proved to be routine. (Par. 647-653, 685-687)

58. [The modest Latin American operational participation in the Quarantine occurred near the end of the crisis and was of little military significance.] The contributed ships were made part of a separate U.S. task force, and the only special command and control problem was providing each foreign ship

TOP SECRET

- 18 -

~~TOP SECRET~~



TOP SECRET

~~TOP SECRET~~

with a U S. communication liaison team having bilingual operators and appropriate cryptographic equipment. (Par. 616-636, 688-690)

CONTINGENCY PLANNING DURING THE CRISIS

59. Command and control considerations pervaded contingency planning during the crisis. The function of the plans themselves was essentially as a vehicle of command and control to optimize military responsiveness to national political direction. Concern at the political decision-making level with operational details deemed critical to the larger U.S. strategy in the crisis accounted for most of the planning activity and largely determined the content of the provisions that resulted.

60. The contingency plans became the midpoint on a projected spectrum of military courses of action ranging from the naval quarantine, on one extreme, to general war on the other. But because Cuba was the immediate locus of the crisis issue, the contingency plans remained central to the total U.S. response and were accordingly a major focus of attention for the entire national politico-military command and control complex. (Par. 502-505, 628)

61. Much the same general patterns as had been evident before the crisis characterized contingency planning experience during the crisis -- only they were more pronounced. A salient difference was in the greatly accelerated pace and intensity of the planning, but despite the changed context, the basic form and substance of the earlier plans were retained. The two types of contingency planning undertaken prior to the crisis, i.e., [for air-strike operations and invasion,] continued to be developed as two separate plans. [The basic air-strike plan]

TOP SECRET

- 19 -

~~TOP SECRET~~

TOP SECRET

~~TOP SECRET~~

[ was settled upon early, but owing to problems of meeting political requirements for minimal lead time, a single definitive version of the invasion plan did not effectively crystallize until the acute phase of the crisis was ending.]

(Par. 692, 693, 698-781 passim)

62. Neither of the two contingency plans ever reached final completion, but, owing to modifications and additions, were constantly in a state of transitional growth. Although individual portions gained specificity, the plans as a whole, rather than being narrowed by materialization of the crisis, progressively expanded in dimension and detail. The cumulative effect over time was a considerable transformation of the original plans. (Par. 693-696, 777-781)

63. The associated command and control processes also were similar to precrisis practice. As in other crisis-related military activity, the highest echelon of national political authority interposed itself into the contingency planning machinery. The dominant factors influencing the plans, besides the concrete limitations set by available military resources, proved to be assessments by political decision makers of the intrinsic military situation in Cuba; and interpretations by the same political decision makers of the significance of that military situation in terms of operational planning needs -- evaluations that did not always coincide with the views of the military. The typical role of the JCS was, as before the crisis, largely still that of intermediary agency between planning principals. (Par. 699 767, 787-793, 812, 819-837)

64. [Within the OJCS, the special "Cuban Planners" group was created in the Operations Directorate to deal with]

TOP SECRET

- 20 -

~~TOP SECRET~~

TOP SECRET

~~TOP SECRET~~

[ contingency planning matters exclusively. Organizationally separate from the Joint Battle Staff or regular Divisions and Branches of J-3, the Cuban Planners functioned independently of established channels and procedures. Rather than substantive planning, their job was one of monitoring and providing informational coordination and staffing support in connection with the plans.] (Par. 714-724)

65. Within LANTCOM headquarters, as soon as tactical command for planned contingency operations was centralized to give CINCLANT operational control over all forces involved, a separate LANTCOM staff was formally activated to handle Cuban contingency responsibilities, including planning. The special contingency staff, however, did not function as intended. Instead, it was informally integrated into the regular permanent CINCLANT staff, which performed the Cuban staffing along with general-war staffing. (Par. 748-755)

66. Lack of unequivocal criteria for determining the approval status of basic plans, components, and changes at any given time made for an element of procedural ambiguity, potentially of far-reaching command and control consequence. Various kinds of approval, and inconsistencies in their application, sometimes made it impossible to know which particular planning provisions were currently governing and official. (Par. 699-712, 731, 805, 832, 833)

67. Stringent security restrictions imposed in the early stages of the crisis were an added constraint militating against full and timely dissemination of planning information to all the staffs and forces affected by the plans. The tendency persisted even after security restrictions were relaxed, [ and was especially evident in the use of the severely limiting "EXCLUSIVE FOR" device on messages crucially pertinent to planning.] (Par. 717, 718, 753, 800-805, 834)

TOP SECRET

- 21 -

~~TOP SECRET~~

~~TOP SECRET~~

TOP SECRET

68. The same themes that dominated precrisis contingency planning were the major planning problem areas during the crisis. All were traceable to command and control desiderata of the national political authority. [Centralizing of command relations was accomplished relatively early, but reduction of reaction times, discriminate force application, and augmentation of force levels, were more complicated and exercised a greater portion of the total national command and control system.] (Par. 697, 725-747)

69. [Compliance with recurrent White House insistence on minimizing the time lag between a political decision to execute military action and implementation of the action ordered placed a great strain on both contingency planning and operational readiness preparations. Crucial to the whole command and control process involved was reciprocal information exchange. As the number of planned specific courses of action multiplied, settling upon reaction times that were both politically acceptable and militarily feasible necessitated intensive coordination between planning and operations, and in the interim, occasioned no little confusion before the various reaction times were firmly codified and universally understood.] (Par. 797-812)

70. [Preoccupation with discriminate force application within the scope of the contingency plans reflected in microcosm the underlying strategic concern with escalation that characterized the whole U.S. approach to the crisis. The elaborate definition of selective options in ascending order of magnitude, coupled with austere reaction times, grew out of Presidential demands for precise and virtually instantaneous military response capability to implement predetermined operational courses of action, in discrete increments of specified kind and measure, on call. Such fine-grained choices from a range of programmed]

TOP SECRET

- 22 -

~~TOP SECRET~~

2

~~TOP SECRET~~

TOP SECRET

[alternatives as was ultimately provided for in the contingency plans made for unprecedented national decision flexibility.]  
(Par. 756-773, 843, 844)

71. Augmentation of force level commitments for contingency operations accounted for extensive planning modifications throughout the crisis period. The steady force increase was partly related to order-of-battle intelligence factors, and in part to planning refinements designed to accommodate secondary or peripheral requirements or to cover more remote exigencies that might conceivably occur. The chief motivation, however, was the desire on both operational and policy levels to insure adequate safety margins. On the one hand, tactical commanders on various echelons were inclined to add, on their own initiative, combat strength in excess of what they were authorized to deploy, and the plans would subsequently be adjusted accordingly. On the other, political decision makers, remembering the Bay of Pigs experience, formally directed further large-scale augmentation, even in the face of military advice to the contrary. (Par. 766, 814-827, 838-841)

72



(Par. 787-794)

73. In view of the nature of some of the planning issues dealt with, the essential information requirements for staffing support

TOP SECRET

- 23 -

~~TOP SECRET~~

~~TOP SECRET~~

TOP SECRET

of many planning actions were fundamentally in the realm of judgment. Some of the information inputs demanded of the military command and control system amounted to hypotheses in a subjunctive mode, rather than hard data in the sense of verifiable facts.

(Par. 767-769, 787-792, 799)

TERMINATION OF THE CRISIS

74. Successful resolution of the crisis was achieved primarily through diplomatic measures conducted at the national political level. The specific means employed were bilateral communications in the form of a dialogue involving an exchange of messages between the U.S. and USSR heads of state. Military command and control had no direct participating role in the actual dialogue itself. (Par. 845-873)

75. [On the eve of the Soviet concession to withdraw the missiles, the military command and control system did expressly attempt to influence national decision making regarding the next U.S. move. In the light of the continuing missile buildup, the JCS, as a corporate body but minus the Chairman, formally proposed implementing the contingency plans in 24 hours unless there were in the meantime evidence of Soviet compliance to remove the missile threat. The Chairman disagreed with the JCS position and independently submitted his own separate recommendation that, instead, the U.S. wait longer for further Soviet reactions.] The incident revealed a conjuncture of two different orders of command and control activity bringing into conflict the Chairman's dual role as an integral part of one institutional command and control system (the military) and his simultaneous ad hoc functions as a member of another (the national political). As he felt constrained to explain in his dissenting memorandum, the Chairman had been unable to participate in the JCS deliberations because at the time he was at the White House functioning in a staff capacity as the military member of the NSC Executive Committee. (Par. 873-875)

TOP SECRET

- 24 -

~~TOP SECRET~~

~~TOP SECRET~~

TOP SECRET

76. Attending the gradual military unwinding that characterized the termination of the crisis were many command and control requirements, though progressively less urgent and less crucial. A series of decisions and complex operational coordination was necessary to maintain a balanced and orderly stand-down of operational readiness in phase with political developments, the military significance of which was not always clear at the time. Concomitant with the return toward normal precrisis posture was a decrease in intimate participation by national political decision makers in the immediate operational details of reducing military readiness. (Par. 845, 876-883)

77. As tensions eased and the crisis subsided, the ad hoc military command and control adjustments were abandoned, although not necessarily to revert to precrisis arrangements. Within the Operations Directorate of the Joint Staff, particularly, a number of basic changes in command and control organization and procedures were put into effect even before the crisis was over. (Par. 884-897)

78. Throughout the crisis, the military command and control system, including that portion represented by the OJCS, had been confined almost exclusively to technical military matters following on decisions already rendered by national political authorities. There was little tendency on the part of the Executive Office to relinquish centralized control and delegate autonomous prerogatives along institutional lines to the military establishment in its own traditional sphere of vested interest. Generally, most of the managerial initiative shaping the U.S. military response was exercised at the very apex of government.

TOP SECRET

- 25 -

~~TOP SECRET~~

~~SECRET~~

DISCUSSION

I. INTRODUCTION: PRECRISIS U.S. POLICY TOWARD CUBA

79. During the first three years of Castro's rule in Cuba, it became quite clear that the Soviet Union fully recognized the advantages to be derived from a Cuba hostile to the United States. In the increasingly exacerbated course of U.S.-Cuban relations during these years, Cuba became the recipient of Soviet moral and material support. The latter, in the form of economic aid and military equipment, was relatively modest in scope, and probably had a greater symbolic than actual impact. It was a marked change in this pattern which led to the missile crisis of 1962.

A. THE SOVIET BUILDUP IN CUBA

80. The commencement of unusually large shipments of arms to Cuba from the Bloc nations in the early summer of 1962 brought the Cuban question to the forefront again after a considerable period of Caribbean quiescence. Arms, industrial materials, military advisors, and civilian technicians began to pour suddenly into the island. Shortly, there began the swelling flow of intelligence reports to the U.S. which indicated that more than the usual ground combat and aircraft weapons, of a type which Cuba had been receiving for the previous two years from the Bloc, were now being moved in. (For further discussion of the details of intelligence developments, see paragraphs 201-206 below.)

81. President Kennedy made the first public statement in regard to the increased flow of men and materiel at his press conference on August 22.<sup>1</sup> Six days later, Tass, the Soviet News Agency, announced that the volume of shipments from the Soviet Union to Cuba in 1962 would be double that of 1961 and that, at the moment, ten Soviet ships and five of West German, Norwegian, Greek, and Italian registry were on their way to

<sup>1</sup>New York Times, August 23, 1962.

~~SECRET~~



~~SECRET~~

Cuba.<sup>1</sup> On September 2, the Soviets confirmed what had been known by announcing an agreement to supply arms to Cuba and to provide specialists to train the Cuban armed forces.<sup>2</sup>

82. These developments produced a growing pressure within American official circles for strong measures against Cuba, including invasion of the island to destroy the Soviet Base in embryo. Such forceful action, however, required more concrete information and evidence than was currently possessed. Furthermore, political reactions, in the light of the abortive expedition to the Bay of Pigs in April 1961, had to be considered.

83. Consequently, U.S. declaratory policy was to rule out invasion, but to keep up a relentless pressure, with the economic embargo the U.S. had placed on Cuba, to isolate the island, and to allow and to help internal forces build up to the point where the Castro government could be overthrown. The President himself ruled out invasion in an August 29 press conference, in a reply to suggestions from Congressional sources that the U.S. invade Cuba because the presence of Soviet troops had violated the Monroe Doctrine.<sup>3</sup> However, the President did follow up with another statement on September 4, after consultation with Congressional leaders, declaring that the U.S. will use "whatever means may be necessary" to prevent Cuba from exporting "its aggressive purposes by force or the threat of force against any part of the Western Hemisphere." He stated that "there is no evidence of any organized combat force from any Soviet Bloc country; of military bases provided to Russia ... of the presence of offensive ground-to-ground missiles .... Were it to be otherwise, the gravest issues would arise."<sup>4</sup>

84. Over the long term, U.S. policy was even more emphatic. On September 30, the Vice-President, Mr. Johnson, defined the U.S.

<sup>1</sup>New York Times, August 29, 1962.

<sup>2</sup>New York Times, September 3, 1962.

<sup>3</sup>New York Times, August 30, 1962.

<sup>4</sup>New York Times, September 5, 1962.

~~SECRET~~

SECRET

aim in Cuba as getting rid of Castro and Soviet influence. Ambassador Stevenson said on October 8 in a statement to the United Nations in regard to U.S.-Cuban policy, that the "maintenance of communism is not negotiable."<sup>1</sup>

85. However, for the moment, the U.S. would depend upon non-military measures to hamper, if not prevent, the flow of arms to Cuba. For these measures to have effect, the cooperation of our European and Latin American Allies would be indispensable.

B. ATTEMPTING TO IMPLEMENT AMERICAN POLICY

86. That a large part of the Soviet commerce with Cuba was carried in Free World bottoms was painfully clear to American decision makers. On September 10, 1962, the Chief of Naval Operations reported that since January 1, 1962, 169 Free World ships had made 246 trips in the Cuban trade under 175 charters fixed by the Sino-Soviet Bloc.<sup>2</sup> The New York Times reported on September 28 that of the slightly more than 1000 merchant ship calls at Cuba between January 1 and September 1, 1962, only about 275 were by Bloc ships. Nearly 500 were by ships operated and owned by Free World owners. In the same period, Free World ships carried about 56 percent of the Soviet oil on which Cuba depended. Free World ships also carried almost 80 percent of the dry cargo received by Cuba. However, almost none of the Free World ships carried arms, and the ships of some western Allies had increasingly sailed away from "strategic goods."

87. The U.S. in August had consulted with NATO Allies whose shipping firms had chartered vessels to the Bloc, but by mid-September it was apparent no major gains had been made. The Governments of Britain, West Germany, and Norway had begun inquiries among their shipowners, but these were generally regarded as polite responses to U.S. diplomatic pressure, and centered on the question of whether Allied ships were carrying arms among their cargoes to Cuba. U.S. officials attempted to point out

<sup>1</sup>New York Times, October 9, 1962.

<sup>2</sup>JCS 2304/62, 1 October 1962, SECRET.

SECRET

~~SECRET~~

to these Governments that the use of Allied ships for even ordinary goods carriage to Cuba released that many Bloc ships for arms delivery.<sup>1</sup>

88. American dissatisfaction with the situation was startlingly formalized on September 20 when the House of Representatives approved the foreign aid bill, including amendments which would cut off all aid both to states whose ships carried arms to Cuba, or which sold or furnished arms or supplies of strategic value like petroleum, and to states whose ships carried just items of economic assistance to Cuba. While the Senate, on October 1, voted to restore the President's discretionary power in the second category, to determine whether or not such withholding of aid would be contrary to the national interest, the depth of American concern and intent was made manifest.<sup>2</sup>

89. In the second half of September, some small progress appeared to be made in enlisting the support of Western European Governments in measures to restrict the use of their shipping by the Soviets in the Cuban arms traffic. On September 25, Secretary of State Rusk met with the British Foreign Secretary, Lord Home, to discuss the embargo, and then conferred with Norwegian officials the following day. On the 25th the British Government officially advised British shipowners to refrain from carrying arms to Cuba, and five days later the President and Lord Home issued a joint statement in regard to the serious nature of recent developments in Cuba.<sup>3</sup>

90. However, the only concrete success American diplomacy scored was the announcement on September 27th by the Turkish Foreign Minister that Turkish shipowners had agreed to halt all cargo shipments to Cuba. This was hardly a major blow to the Cuban trade.

<sup>1</sup>New York Times, September 15, 1962.

<sup>2</sup>Department of State Outgoing Circular Telegram 655, October 12, 1962, UNCLASSIFIED.

<sup>3</sup>New York Times, October 1, 1962.

~~SECRET~~

S E C R E T

91. Lack of success led the Administration into consideration of harsher and far-reaching embargo measures. An interesting memorandum from the Secretary of the Navy to the Secretary of Defense on September 20th enclosed a letter for the President in regard to a "study on a declaration barring ships in the Cuban trade from entering U.S. ports." The letter suggested several nonnaval courses of action which could have the effect of naval actions. The least effective measure was a Presidential Declaration that ships calling at Cuban ports may not call at U.S. ports immediately thereafter or for a specific period thereafter. Since only 144 of the 575 Free World ships engaged in the Cuban trade had subsequently called at U.S. ports in the past two years, ship operators could probably live with this ruling by adjusting their schedules to cover the period of ostracism.

92. A second suggestion was a Presidential Declaration that all ships engaged in the Cuban trade were barred from U.S. ports until further notice. Such an act would have an inhibiting long-range economic implication of varying intensity for each of the approximately 70 beneficial owners of the 575 ships. The inhibiting effect could be heightened by requesting Western countries, especially Latin America, to make similar rulings regarding ships not of their own registry and not specifically protected by treaty. Some of the beneficial owners who could easily operate a few ships to Cuba without using U.S. ports would be greatly inhibited by the financial burden of having to bring these ships home empty and in ballast from the Western Hemisphere. A lesser but significant degree of refinement could be obtained by just circulating reports that such a request to Latin American states was under consideration.

SECRET

~~SECRET~~

93. The third and most effective recommendation would be a declaration that no ships belonging to the beneficial owners of any ships calling at Cuba would be allowed into U.S. ports until further notice. This action would have amounted to black-listing owners and their entire fleets if a single ship called at Cuba. Such a declaration would admittedly be difficult but not impossible to enforce. These then, were some of the policy options open to the U.S.

94. The Secretary of the Navy pointed out that, from the Navy's point of view, all three courses of action were legal, but there must also be taken into account the opinions of all other Government agencies in regard to subsidiary effects upon U.S. trade, foreign relations generally, and hemispheric economic relations specifically.<sup>1</sup>

95. The ultimate choice of means was a combination and drastic extension of the Navy's suggestions. On October 3 the U.S. delegate informed the North Atlantic Council of NATO that the U.S. Government would launch the following "Four Point Action Program" next week: (1) Close all U.S. ports to all ships of any country if any ship under that flag thereafter carried arms to Cuba; (2) Direct that no U.S. Government cargo shall be carried on a foreign flag ship if any ship of the same owners is used hereafter in the Bloc-Cuban trade; (3) Direct that no U.S. flag ship and no U.S.-owned ship shall carry goods to and from Cuba, and (4) Close all U.S. ports to any ship that on the same continuous voyage was used or is being used in Bloc-Cuban trade. The U.S. delegate reiterated that those proposals reflected the continuing seriousness with which the U.S. Government, Congress, and the American public viewed the

<sup>1</sup>Memorandum for the Secretary of Defense, from the Secretary of the Navy, 20 September 1962, SECRET.

~~SECRET~~

~~SECRET~~

Cuban shipping problem and the importance we attached to making the Soviet build-up as expensive and difficult as possible. The U.S. recognized that these measures may cause problems for shipping companies in some NATO countries, but we hoped that the NATO Governments would be able to persuade them to make adjustments. The OAS was informed of these measures by the Secretary of State on October 2.<sup>1</sup>

96. While the first reports indicated that North Atlantic Council representatives had seemed to appreciate the seriousness of the U.S. presentation, reactions to the forthcoming measures were obviously mixed. A major success was achieved, the first one in regard to Free World shipping, when on October 10, the Greek Shipowners Union in Athens announced that it would recommend to its members a total embargo on cargo shipments to Cuba. Since the U.S. Maritime Administration had but recently revealed that Greece had led the list of twenty-two Free World countries whose ships were conveying Communist cargoes to Cuba, with 97 ships of the 432<sup>2</sup> involved, this appeared to be a step in the right direction.

97. However, in the case of Britain which came second on the list with 77 ships, the reaction was different. British shipowners in London decided unanimously on October 11 to oppose any U.S. restrictions on their trade with Cuba. Press reaction to the American policies was hostile, and

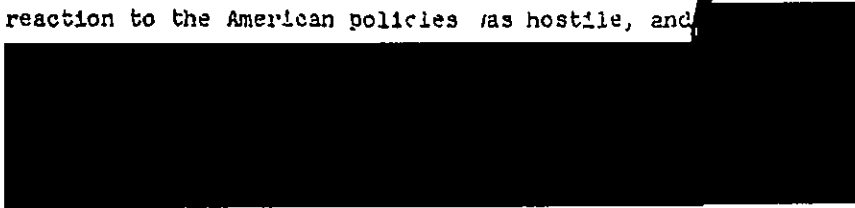

<sup>1</sup>Department of State, Circular Telegram 580, 3 October 1962, CONFIDENTIAL.

<sup>2</sup>New York Times, October 1, 1962.



~~SECRET~~

~~SECRET~~

E

BIAY

98. To counteract such attitudes the State Department sent out a cable defining the "U.S. Four Point Action Regarding Cuban Shipping." The telegram summarized the nonmilitary stage that had been reached in U.S. policy just before the receipt, three days later, of positive intelligence of Soviet offensive weapons abruptly turned American efforts toward more forceful measures. U.S. policy, it stated, was intended: (1) to deny the Bloc and Cuba access to Free World shipping for use in arms shipments to Cuba; (2) to make the Bloc-Cuban trade as costly as possible for Free World shipowners by denying their ships engaged in that trade the opportunity to call at U.S. ports on the same voyage; (3) to compel shipowners and operators to elect between engaging in Bloc-Cuban trade and in carrying cargoes financed by the U.S., such as foreign aid cargoes, shipments of surplus agricultural commodities under Public Law 480, and Department of Defense cargoes.

99. The message concluded by stating that it was not the American objective at this time to achieve by unilateral action a complete embargo on Free World trade with Cuba. The U.S. itself did permit exports to Cuba of certain foodstuffs and medical supplies. However, the efforts of other countries to curb trade and especially to prevent or discourage the use of vessels under their registry from engaging in trade would be consistent with U.S. objectives and would be welcomed by the U.S.

BIAY

<sup>2</sup>Department of State Circular Telegram 648, October 11, 1962,  
SECRET.

~~SECRET~~

S E C R E T

100. The message was clearly making a fine distinction, since the measures proposed, if effectively implemented, would have produced a situation very close to a complete embargo.

101. However, there was a limit to concern for our Allies. A State Department cable of a few days earlier had stated that the Department wished to make clear that although it wanted to hear of significant reactions, in this case from Latin America, to the U.S. Four Point Action program, adoption of the measures was not dependent upon the reactions of others. The U.S. Government would take these<sup>1</sup> measures.

102. This, then, was the nonmilitary aspect of U.S.-NATO relations over Cuba. There was, however, another aspect to the relationship.

### C. CUBA AND BERLIN

103. Until late in the summer, American decision-makers appear to have considered Berlin the next most likely crisis area rather than Cuba. The impression given in Washington was that a new crisis in Berlin might have to be faced by the turn of the year, assuming Khrushchev kept his promise not to sign a peace treaty until after the American elections. The apparent U.S. insistence upon keeping the subject current led to some puzzlement among observers. In view of the widespread doubts that the Soviets would actually start a new Berlin crisis in the near future, it could be surmised that the U.S. objective was to warn the Soviets of U.S. resolve, and by keeping the subject current, to prepare the American public for the possible threat of war in the coming future.

---

<sup>1</sup>Department of State Circular Telegram 599, October 5, 1962, CONFIDENTIAL.



~~SECRET~~

104. Berlin remained the subject of greatest U.S. and NATO public attention until virtually the very day of the President's proclamation of the Cuban quarantine. In fact, the six-and-a-half-hour conversation between the President and Soviet Foreign Minister Gromyko on October 18, in the midst of preparations for the U.S. Cuban move, dealt in greater part with Berlin. On the 17th Washington sources had indicated too that Khrushchev was due to visit the U.N. and to see the President the following month in order to discuss Berlin.

105. It was obvious that American decision makers conceived of a direct relationship between Cuba and Berlin. The development of the Soviet base in Cuba could be viewed as a pawn to be used in the greater game over Berlin, even if no offensive weapons had been introduced. The possibility of the introduction of these weapons made the relationship all the more certain and critical.

106. Secretary of State Rusk, in a briefing to a joint session of the Senate Foreign Relations and Armed Forces Committees on September 17, pointed out the "direct relationship" between events in Cuba and Berlin, particularly in the next three months. It is interesting to note that in the discussion which ensued, an analogy was drawn by the Senators between the Cuba and Berlin relationship and the impact of the British-French invasion of Suez on the Soviet decision to go all the way in smashing the Hungarian insurrection in early November 1956. (Curiously, these two most critical crises of the decade were to coincide almost to the day, six years apart). The theory expressed was that the West's invasion of Egypt distracted world attention from Budapest, permitting the Russians a freer hand.<sup>1</sup>

<sup>1</sup>New York Times, September 16, 1962.

~~SECRET~~

~~SECRET~~

107. In the light of public discussion of the Cuba-Berlin relationship, it was inevitable that public speculation should develop over the possibility of a "deal" between the U.S. and the Soviets. Cuba also became linked in this speculation with the U.S. base system overseas. However, on September 30, the Secretary of State, in a press conference, categorically rejected the idea of a deal with the Soviet Union under which the Soviets would withdraw from Cuba in return for the U.S. closing down some of its overseas bases. The Secretary declared this was not a negotiable point, and that the principle that freedom cannot be supported in one place by surrender of freedom in another would also apply to any effort to link Cuba with a settlement on Berlin.<sup>1</sup>

108. The Soviets took the same line, Izvestia on October 17 denying rumors that the Soviets were sponsoring a deal, and rejecting the idea of any effort to link Cuba to either Berlin or to the U.S. overseas bases.<sup>2</sup>

109. While U.S. officials denied that there existed any negotiable link between Cuba and West Berlin, they also persistently warned that there was a "factual link," in the sense that action in one place might become the signal for counteraction in the other.

110. The effect of these speculations and exchanges upon the NATO Allies cannot be fully identified, but it seems clear that part of their unsympathetic attitude toward U.S. Cuban policy had its roots in fears that the American "obsession" with Cuba would blind the U.S. to the really vital situation in Berlin. It was felt that the U.S.

---

<sup>1</sup>New York Times, October 1, 1962.

<sup>2</sup>New York Times, October 12, 1962.

~~SECRET~~

~~SECRET~~

"creation" of a crisis in Cuba would invite Soviet pressure in Europe and thus provoke the very crisis we were seeking to delay if not avoid in Berlin.

111. This sensitivity to the Cuba-Berlin relationship revealed itself clearly in the widely held expectation, once the Quarantine had been announced on October 22, that the most likely place for a Soviet counterpressure would be in Berlin. The very fact that the President, in his address on October 22, specifically warned the Soviets against interfering with U.S. access to Berlin or against any other "hostile moves" suggests the weight which U.S. policy makers attached to the relationship.

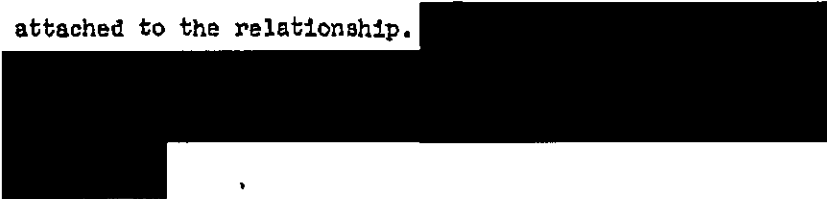

#### D. LATIN AMERICAN STATES AND U.S.-CUBAN POLICY

112. The interest of the Latin American states in the new American policy toward Cuba was not so much mercantile as political. For some, those states in or bordering on the Caribbean, there was also a military interest, since they had been the objects of the several Castro-inspired little filibustering expeditions around the Caribbean in previous years. At the governmental level at least there existed in these states a strong antipathy toward Castro's Cuba. On the other hand, the major Caribbean state, Mexico, had shown itself most cool toward earlier U.S. efforts to penalize Cuba.

113. The rapid growth of Cuban military power during the year had shaken complacency and tolerance. Consequently, when Secretary of State Rusk met with the Ambassadors of nineteen Latin American states on September 5, his

~~SECRET~~

~~SECRET~~

declaration of U.S. determination to prevent the export of Communism from Cuba was well received. There was apparently full unanimity with the President's "containment policy" that would involve the use of whatever means might be necessary to prevent aggression by Cuba against any part of the western Hemisphere.<sup>1</sup>

114. A more specific statement of U.S. policy was made by the Secretary of State on September 26 to the Foreign Ministers of Chile, Haiti, Peru, and Venezuela. The Secretary reviewed the Cuban situation, emphasizing the rapid Soviet build-up. He stated that if it should become necessary for the U.S. to take military action, only three or four hours' preparation would be required to reduce the effectiveness of the Soviet war materiel so far received since July. If it should be necessary to use force, the U.S. would use the maximum nonnuclear violence in order to minimize time and casualties. However, the U.S. was anxious to avoid this course since it would leave lasting wounds both in Cuba and elsewhere.

115. For this last reason, the U.S. was currently pursuing the objective of making Soviet involvement in Cuba as expensive and as unprofitable as possible for the Soviet Union by measures which would further isolate Cuba and exert maximum nonviolent pressure on the Soviet Union. He strongly emphasized that the U.S. was not objecting to whatever type social and economic system the Cuban people might freely choose, but only to Soviet intervention there and to Soviet-Cuban intervention in Latin America.

---

<sup>1</sup>New York Times, September 6, 1962.

~~SECRET~~

~~SECRET~~

115. The Secretary stressed that the U.S. was unwilling to negotiate the Cuban problem with the Soviet Union. Because of special inter-American relationships and agreements, the Cuban situation was in no way comparable to or linkable with situations elsewhere, such as Berlin or U.S. military assistance relationships with other free countries like Turkey. He stressed that the U.S. was not seeking to import the cold war into this hemisphere or to drag the OAS into problems not their responsibility. The Soviet Union had brought the cold war to the hemisphere. In conclusion, Mr. Rusk pointed out the intense preoccupation of the American people with Cuba and asked his Latin American colleagues that this be taken into account in their thinking as a current basic political fact of life in the United States.<sup>1</sup>

117. To gain further support for a stronger U.S. policy, the U.S. called an informal meeting of all Latin American foreign ministers to be held in Washington, October 2-3. The invitation was sent specifically to discuss the Cuban situation in the light of the Soviet build-up there, the tempo of which had increased steadily throughout September. The U.S. Secretary of State reviewed recent developments and the U.S. response in the setting of a worldwide Communist offensive. He expressed the view that the Soviet Union would not go to war over Cuba, but reassured the OAS ministers that in the event of a sneak attack on the U.S. or elsewhere, the U.S. would still be able to destroy the Soviet Union. He invited their views on how to make the

<sup>1</sup> Department of State, Telegram to U.S. Mission at U.N., September 27, 1962, CONFIDENTIAL.

~~SECRET~~

~~SECRET~~

Bloc's supplying of Cuba more difficult and costly and how to demonstrate that Communist action in Cuba would not affect hemisphere solidarity. In this last point he was backed strongly by the Foreign Ministers.<sup>1</sup>

118. It is interesting to note that the sense of the Secretary's comments at this meeting closely resembled comments he had made a week earlier, in his references to military action. [It would appear that a positive effort was being made to alert the OAS to the possibility of military assault against Cuba if the situation there continued down the same path.]

119. There was a military side to the conference, for which U.S. planning provides an interesting background for the concept of U.S.-Latin American military cooperation which emerged during quarantine operations a month later. In fact, these ideas are shown to have been under consideration for some length of time.

120. Prior to the conference, the President had let it be known to the CJCS that he desired to adopt a strong position on CoCoa, and wished a number of points to be raised at the conference in the military field. These were to include the need for an increased air-sea surveillance of Cuba and its approaches on both unilateral and multinational basis; the establishment of sea-air surveillance of the coasts of Caribbean states, on a multinational basis, to prevent infiltration; the establishment of more active counter-subversion activities by the Caribbean states, to include exchange of information between countries and with the surveillance force.<sup>2</sup>

<sup>1</sup>Department of State Circular Telegram 577, October 3, 1962.  
CONFIDENTIAL.

<sup>2</sup>JCS 2304/61, 23 September 1962, SECRET.

~~SECRET~~

~~SECRET~~

121. The President's points were clearly designed to further the U.S. policy of isolating Cuba and limiting her ability to engage in mischief-making with her newly acquired Soviet weapons. (As early as May 1962, the JCS had expressed concern to CINCARIB and CINCLANT over the possible Cuban utilization of eighteen newly received patrol and motor torpedo craft in landing subversive personnel around the Caribbean, and had directed them to organize a system of control and surveillance.)<sup>1</sup>

122. The CJCS in his reply first warned that in the preparation of a public political statement to be issued by the Foreign Ministers, there be no mention of invasion or the use of blockade as a major means of handling Cuba, suggesting that instead, discussion should be concentrated on actions designed to prevent the export of Communism.

123. The Chairman pointed out that the JCS had already taken actions along these lines in August 1962, having directed CINCARIB and CINCLANT to develop a U.S. alerting system to include anti-infiltration phases in all exercises and to encourage Caribbean states to develop country alerting systems with plans for opposing subversive infiltrations. However, the foregoing actions were clearly dependent upon participation of the states concerned, and the U.S. position at the meeting should, therefore, lay emphasis on these actions and invite greater participation.

124. In regard to the President's aforementioned three points of interest, the Chairman noted that U.S. military forces provided what was felt to be adequate surveillance, and, if necessary,

---

<sup>1</sup>JCS Message 4446, to CINCARIB, CINCLANT, 091046Z, May 1962, SECRET.

~~SECRET~~

~~SECRET~~

could alone extend it, since the Caribbean states would be hard pressed to provide surveillance of their own coasts. If it were considered politically desirable to elicit surveillance contributions, Mexico, Venezuela, and Colombia were capable of providing assistance. He warned that creation of a multinational force would require that contributing nations be provided with additional fuel and spare parts support.

125. The Chairman recalled that the JCS had given its position on a multinational patrol on two previous occasions, namely, that the military advantages would not be significant. Nevertheless, this position need not preclude encouraging cooperation among the Caribbean states, and the central theme of the U.S. at the meeting should be to encourage a marked unilateral effort and multinational cooperation in the maximum utilization of existing facilities and forces.

126. In retrospect, the American political and military positions were revealed with both clarity and fullness to the OAS at this conference. There could be no mistaking U.S. intentions toward Cuba, presuming the will to execute the declaratory policy existed.

11-977-62, 24 September 1962, SECRET.

~~SECRET~~



TOP SECRET

~~TOP SECRET~~

## II. PRECRISIS MILITARY CONTINGENCY PLANNING

### A. GENERAL CHARACTERISTICS OF THE CONTINGENCY PLANNING

127. The main vehicle of preparation for the Cuban crisis was the military contingency plans. Long before the event, relatively elaborate planning had been undertaken in anticipation of a contingency arising that would require U.S. military action against Cuba. This planning was in process when the crisis came.

128. For the preceding period of well over a year, as the general Cuban situation worsened, a growing sense of urgency progressively accelerated the pace of contingency planning, while the scope of the plans enlarged and the scale of operations provided for expanded. By the eve of the crisis, there existed a body of contingency plans in various stages of development, some completed and formally adopted, others being formulated, undergoing revision, or awaiting review and approval. Among them were not a few unreconciled inconsistencies. Together these plans constituted, to the extent that they were developed, the prepared point of departure for a U.S. military response to a Cuban contingency.

129. The compass of these precrisis contingency plans was intended to be comprehensive. Within the bounds of the contingency postulated, the range of optional courses of action under consideration was fully expected to cope with whatever the contingency presented. [When the actual contingency materialized, the resulting plans were found to be less than all-inclusive and fell short of accommodating the entire military dimensions of the total crisis. Furthermore, over and above limitations of concept, the state of the planning at the time the crisis occurred proved less than propitious for ]

TOP SECRET

- 43 -

~~TOP SECRET~~

TOP SECRET

[generating the explicit plans needed immediately in the heat of the moment. The deficiencies were attributable to the basic premises underlying the substance of the plans and to the way the planning function was carried out.]

130. [None of the working assumptions on which precrisis plans were predicated took into account the possibility of a contingency of strategic proportions in a general war context. Nor did the conduct of the planning, with its ever-changing terms of reference, permit a systematic program of orderly integration and follow-through of the various plans initiated. Nevertheless, different as the character of the real contingency turned out to be, and despite its inopportune timing in relation to the status of the planning, the complex of plans addressed to the hypothetical situation was not rendered invalid. With appropriate modification, plans applicable to one of the major military aspects of the crisis eventually emerged. These precrisis contingency plans, thus, although not oriented specifically to the kind of conditions to which they had to apply, were in the direct line of evolution leading to those that became current and in effect during the crisis.]

131. In view of their formative role in influencing subsequent crisis experience, it is necessary to trace the ontogeny of the precrisis plans and reconstruct the contemporary environment in which planning developments occurred. In the course of isolating the impetus, rationale, and circumstances of particular planning actions taken, significant command and control phenomena bearing upon contingency planning processes can be identified.

B. ORIGIN OF THE CUBAN CONTINGENCY PLANS

132. [The contingency military operation plans for Cuba had all evolved from reaction to a specific traumatic experience.]

1  
A

TOP SECRET

TOP SECRET

some 18 months before the crisis. Their provenance goes back directly to the abortive Bay of Pigs adventure of 17 April 1961. [Immediately following the ignominious collapse of the CIA-sponsored invasion attempt on 19 April, the President directed the Task Force on Cuba, an ad hoc planning group functioning in the Executive Office under the NSC, to prepare a contingency plan for a military invasion of Cuba by U.S. forces. The terms of reference laid down by the President at the time stipulated that the plan provide for the use of "overwhelming force" in order to insure success of the operation. Also included in the guidance given was that the plan be designed with the objectives of bringing about the subjugation of Cuba in the shortest time possible, and of minimizing U.S. and Cuban casualties.]

*facty how  
as a section  
with it  
plan  
to show*

*Handwritten notes and scribbles on the right margin.*

133. [This initial reflex action at the national political level proved to be the genesis of a veritable program of military contingency planning for Cuba, out of which ultimately a "family" of plans culminated.]

134. [Before the end of April 1961, the requested plan was completed by the Task Force on Cuba and submitted to the President. Identified as "Contingency Plan 1," it became the basic national contingency plan for U.S. action regarding Cuba. The mission to be accomplished was to overthrow the Castro regime by military force and install a government acceptable to the U.S. The plan that had been produced, in accordance with the President's directive, called for a relatively large-scale military operation, to invade, subdue, and occupy Cuba. It set forth the terms of reference laid down by the President, refining further the conditions and]

~~TOP SECRET~~ 2304/34, 2 May 1961, TOP SECRET

TOP SECRET

TOP SECRET

~~TOP SECRET~~

Criteria that would apply, and specified the means that were authorized to achieve U.S. military objectives. To carry out the tactical phase of the invasion, the plan provided for the employment of 60,000 troops, excluding naval and air units, but stipulated that all the forces involved, whether land, sea, or air, were to be drawn from existing force levels. Reflecting the President's cardinal requirement, the strength of the force commitment was presumed adequate to give a high degree of assurance of success. In the light of Cuban capabilities as estimated at the time, the allocated force was deemed sufficiently massive to discourage or overcome resistance and permit ground offensives to be conducted at such a pace as to secure effective control of the island in an estimated eight days. Execution of the plan would require a lead-time of twenty-five days from the date of decision to the commencing of D-Day assaults<sup>1</sup>

135. On 29 April 1961 the President, meeting with the Secretary of Defense and the Chief of Naval Operations, reviewed Contingency Plan 1. He approved the general outline of the plan, but demurred with respect to what he considered an unduly long reaction time. Rejecting the twenty-five-day interval provided for between decision and execution, he requested that the lead-time period be drastically reduced, suggesting no more than a week as being desirable. Otherwise, the plan was adopted, and the President directed that the preparation of appropriate detailed military operation plans to implement the national plan be undertaken accordingly.]

<sup>1</sup>JCS 2304/34, 2 May 1961, TOP SECRET.

<sup>2</sup>Memo, SecDef to JCS, "Cuban Contingency Plans", 1 May 1961, TOP SECRET.

TOP SECRET

- 43 -

~~TOP SECRET~~

TOP SECRET

~~TOP SECRET~~ E

136. Henceforth, the issue of reaction time first raised by the President on 29 April 1961 would dominate Cuban contingency planning. The discrepancy between ideal political requirements, on the one hand, and realistic considerations of military operational feasibility, on the other, was never reconciled; but efforts to close the gap lent unforeseen complications to the planning task. The President's demand also marked the beginning of a pattern that was to persist until the 1962 crisis was over. Intensive political direction in technical military operational matters proved to be a salient characteristic of how the U.S. response was managed. ]

137. [ On 1 May the Secretary of Defense, in a memorandum to the JCS, instructed that the "Joint Staff and CINCLANT" be assigned responsibility for preparing the necessary detailed military plan to carry out the course of action prescribed in the national plan. Besides specifying the terms of reference outlined in Contingency Plan 1, and those expressly laid down by the President when he reviewed it on 29 April, the Secretary added guidelines of his own. Citing the requirement regarding lead-time, he emphasized that the military plan be designed to minimize the time necessary for executing the operational response after an order was received. This reaction time, he had determined, should be five days. Finally, he also directed that the plan provide for maximum information security during the intervening period between a decision to invade and the actual assault. ]

138. Thereafter, special security precautions were clamped down on all planning activity regarding Cuba. Within JCS --

Memo, SecDef to JCS, "Cuban Contingency Plans," 1 May 1961

~~TOP SECRET.~~

TOP SECRET

- 47 -

~~TOP SECRET~~

TOP SECRET

~~TOP SECRET~~

and presumably in other interested agencies as well -- these activities were carried on outside the established organizational framework. An exclusive task-force-type group (informally referred to as the "Johnson Task Force"), whose very existence was kept under wraps, was created and functioned in shadowy isolation from the regular affairs of the various divisions and branches of JCS Directorates. Separate procedures were followed in order to limit the number of people who might have access to information that was now considered extra sensitive. From then on, anything pertaining to Cuba was so closely held that only a few designated individuals were privy to what was going on. The rigid security measures that had been imposed acquired, through time, an inertia which was never completely overcome even in the midst of the crisis, when pressing operational needs of the moment demanded somewhat broader access to the data expressly prepared for just such an eventuality.]

139. [A week after the Secretary of Defense memorandum, on 8 May 1961, the Director, Joint Staff, held a conference with CINCLANT representatives in which he gave oral planning guidance, specifying among other things the requirement for a [five-day] reaction time.<sup>1</sup> These terms of reference were confirmed the next day in the JCS message of 9 May that formally directed CINCLANT to produce the contingency plan<sup>2</sup>

140. There was already in existence a not unrelated plan, CINCLANT Contingency OPLAN (Cuba) 312-61. It had been approved by JCS on 10 March 1961, superseding an even earlier one contained in CINCLANT OPLAN 310/60, a general regional contingency plan of which Appendix II to Annex "G" pertained |

<sup>1</sup>JCS 2304/34, 2 May 61, TOP SECRET.

<sup>2</sup>Message, DJS to CINCLANT, 205627, 091728Z, May 61, TOP SECRET.

TOP SECRET

- 48 -

~~TOP SECRET~~

TOP SECRET

~~TOP SECRET~~

to Cuba. The principal difference between the two was that the newer plan provided for increased forces and an expanded operational concept.<sup>1</sup> Though even more ambitious planning was now under way as a result of the President's directive, CINCLANT OPLAN (Cuba) 312-61 continued in effect until eventually cancelled on 27 March 1962,<sup>2</sup> by which time it had been overtaken by the development of still newer contingency plans stemming from subsequent directives of the President or Secretary of Defense.

C. BIFURCATION OF THE PLANNING

141. On the basis of precedent and an existing cognate plan, CINCLANT planners were able to prepare a draft outline of the required contingency plan in relatively short order. On 19 May following the President's directive, the draft outline plan was submitted to JCS for review. It was designed to meet the [five-day] reaction time stipulated in planning guidance; but in the accompanying letter that transmitted the plan, CINCLANT expressed strong reservations regarding the advisability of trying to achieve such a short reaction time. Referring to the serious problems that this posed, even if it were feasible, and pointing out the consequences of doing so, he recommended that it would be in the interest of military efficiency to allow more lead-time than five days. He proposed, instead, appropriate modification of his current OPLAN 312-61 then in force. It could be altered to provide for an eighteen-day reaction time from "Execute" to "Assault," yet offer a high degree of assurance of bringing Cuba under control in a relatively short time.<sup>3</sup>

<sup>1</sup>JCS 2018/248, 1 March 1961, TOP SECRET.

<sup>2</sup>Letter, CINCLANT to JCS, Ser. 048/51, "CINCLANT Contingency Operation Plan (Cuba) No. 312-61 (S)," 27 March 1962 TOP SECRET.

<sup>3</sup>Letter (with Enclosure), CINCLANT to JCS, Ser. 000115/51, "Planning for Quick Reaction Military Action Against Cuba (S)," 19 May 1961; JCS 2304/37, 20 May 1961, TOP SECRET.

TOP SECRET

- 49 -

~~TOP SECRET~~

TOP SECRET

~~TOP SECRET~~

142/ [The JCS, in reviewing the draft outline plan, took into consideration CINCLANT's reservations and concluded that more time than five days should be allowed between the order to execute and the initial assault. They agreed that even if the readiness posture required for such a capability could be achieved, it could not be maintained long because of costs involved and dislocating repercussions on general force posture elsewhere. Certain limitations, including a necessity for prepositioning and redeployment, militated against a realistic plan based on five-day lead-time. In the JCS view, availability of assault sea transport was the determining factor, shortage of which might well preclude a five-day reaction capability. Nevertheless, the JCS decided to approve the quick-reaction outline plan for planning purposes only, while trying to obtain authorization to extend the lead-time as CINCLANT had recommended.<sup>1</sup>

143. Three days later, on 16 June 1961, the JCS advised the Secretary of Defense that more leeway than the stipulated five-day reaction time "must be provided" citing the reasons referred to above. Acting on CINCLANT's proposal, they recommended to the Secretary that a reaction time of eighteen days, from decision to assault, be adopted instead. The JCS pointed out that in an emergency, if urgent need so warranted,

JCS 2304/39, 13 June 1961, TOP SECRET.

TOP SECRET

- 50 -

~~TOP SECRET~~



~~TOP SECRET~~

TOP SECRET

144. [At the same time the JCS informed CINCLANT that, after reviewing the outline plan he had submitted on 1 May 1961, [they agreed with his position that the five-day reaction time needed change. Nevertheless,] CINCLANT was instructed to continue to develop the required quick-reaction plan, cutting the lead-time to as short a period as possible. The concept of operations on which it was to be based was an early airborne assault followed by seaborne build-up. This plan would apply in case a sudden emergency situation necessitated such rapid response. Meanwhile, the JCS granted CINCLANT, the requested authorization to proceed to develop his proposed alternate plan of [eighteen-day] reaction time as a matter of priority ]

145. [Thus, by this action the JCS had set in motion two parallel but different contingency military operation plans for Cuba to be developed simultaneously. These JCS instructions constituted the initiating directive and guiding terms of reference for what were later to become CINCLANT OPLAN 316-61 and CINCLANT OPLAN 314-61, providing for quick reaction and for longer lead-time respectively. [The bifurcation marked the beginning of a proliferation in the contingency planning for Cuba, resulting eventually in the so-called "family" of contingency military plans ]]

<sup>1</sup> Memo, JCS to SecDef, SM-414-61, "Contingency Outline Plan, (Cuba) (S)," 15 June 1961, TOP SECRET

<sup>2</sup> Memo, JCS to CINCLANT, SM-670-61, "Contingency Outline Plan (Cuba) (S)," 15 June 1961, TOP SECRET.

TOP SECRET

- 51 -

~~TOP SECRET~~

TOP SECRET

145. The first contingency plan to be completed was CINCLANT OPLAN 314-61. It was approved by JCS on 30 November 1961, subject to certain conditions, including incorporation of specified changes and receipt of missing Annexes. The operational concept was essentially an elaboration on that contained in the earlier CINCLANT OPLAN 312-61 (Cuba), which had provided for substantially similar operations but with lesser forces. OPLAN 314-61 provided for simultaneous air-borne and amphibious assaults against western Cuba, concentrating on the Havana area, and a concurrent amphibious assault on eastern Cuba. The invasion was to be launched from a prepared readiness posture and would take place approximately [eighteen days] after the execution order was received.

B1. 111  
B1 A2

147. Considerable attention was given to command arrangements. The provisions specified that the Commander, Joint Task Force 122 (CJTF-122), would be the tactical commander responsible to CINCLANT for the assault phase of the entire operation, exercising overall command of all forces involved. The Commander, Second Fleet (COMSECONDFLEET), was designated to function in the role of CJTF-122 when the Joint Task Force was activated. The respective Service component forces making up the Joint Task Force were to be organized into three Service Task Forces under CJTF-122. In addition, the command provisions called for establishment of a "Joint Task Force Cuba" to be commanded by the Army Task Force Commander (who would be CG XVIII Airborne Corps). The latter commander was to exercise operational control over all land

Memo, JCS to CINCLANT, SM-1274-61, "Contingency Operation Plan No. 314-61 (Cuba) (S)," 30 November 1961, TOP SECRET.

TOP SECRET

TOP SECRET

~~TOP SECRET~~

forces (Army and Marine) as soon as the airborne and amphibious assault stage had been successfully completed and the forces were firmly lodged ashore; whereupon he would be the tactical commander in charge of continuing ground operations until the invasion mission was accomplished. As Commander Joint Task Force-Cuba, he would be directly responsible to CINCLANT rather than CJTF-122.<sup>1</sup> Significantly, during the actual crisis, these command relationships spelled out in such detail in 314-61 were abandoned.

B1/11  
B1/12

148. Also contained within OPLAN 314-61 were provisions for development of a separate, alternative "Quick Reaction Plan" utilizing reduced initial forces in the interests of minimizing lead-time. This latter plan was to be, in effect, only a modification of the basic operational concept in 314-61, the main difference being in phasing. employment of airborne assault forces

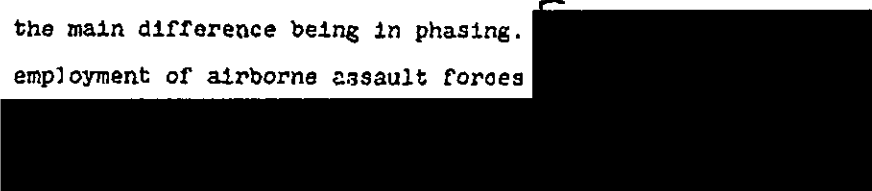

Follow-on forces would then be committed as rapidly as lift capabilities allowed, until eventually the same force strength would be brought to bear as in 314-61. This alternative quick-reaction plan was designated CINCLANT OPLAN 316-61.<sup>2</sup>

149. Meanwhile, despite OPLAN 314-61 having been approved by JCS, its predecessor, CINCLANT OPLAN 312-61, remained in force several months longer. Not until 27 March 1962, when the missing Annexes of OPLAN 314-61 were completed and the various subordinate and supporting plans were well enough

<sup>1</sup>JCS 2018/306, 15 November 1961, (Decision on, dated 30 November 1961), TOP SECRET.

<sup>2</sup>Ibid.

TOP SECRET

~~TOP SECRET~~

TOP SECRET

~~TOP SECRET~~ E

along in development, was OPLAN 312-61 canceled.<sup>1</sup> The designation "CINCLANT OPLAN 312-62" (note: "62") was later applied to identify a totally different contingency plan pertaining to another kind of operation. ] P1 A1 AS

150. Planning activity in connection with both OPLAN 314-61 and 316-61 and subordinate and supporting plans continued apace throughout the remainder of 1961 and into 1962, with JCS and the Secretary of Defense being kept apprised of the progress being made. The quick-reaction 316 plan, in the original version as it was being developed at the time,

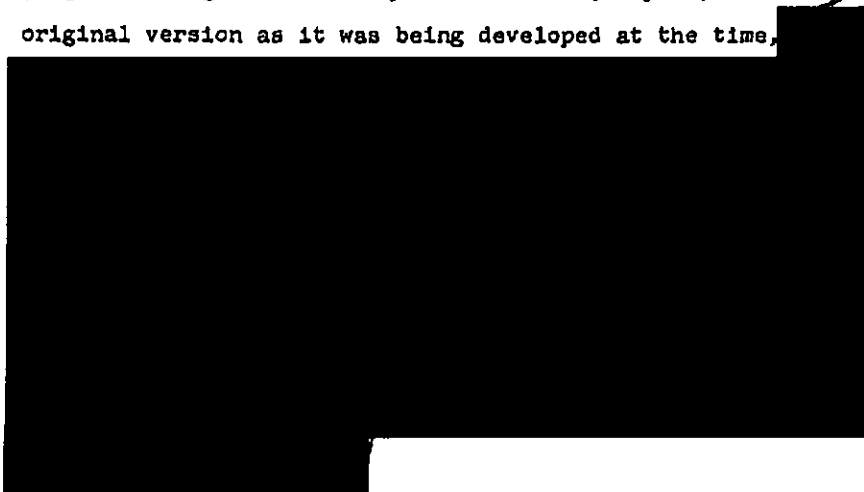

D. INTRODUCTION OF AIR-STRIKE CONTINGENCY PLANNING

151. Early in January 1962 the Secretary of Defense expressed to the JCS strong dissatisfaction with the reaction times being provided for in the contingency plans for Cuba under development so far. The speed of reaction, he felt, was grossly inadequate. In view of the deficiencies of the plans in this regard, the Secretary had decided that what was needed was fast application of U.S. airpower. He therefore directed, first,

<sup>1</sup>Letter CINCLANT to JCS, Ser. 048/51, "CINCLANT Contingency; Operation Plan (Cuba) No. 312-61 (S)," 28 March 1962, TOP SECRET.

<sup>2</sup>CINCLANT Historical Account of Cuban Crisis - 1962 (U). 29 April 1963, TOP SECRET.

TOP SECRET

~~TOP SECRET~~

~~TOP SECRET~~

TOP SECRET

E  
B1  
12  
[That appropriate measures be taken to achieve a rapid-reaction air-strike capability against Cuban military targets, listing in detail the order of priority for specific kinds of targets and the respective reaction times (in terms of hours) for each from a condition of no alert. [Secondly, he also directed that the 18-day reaction time provided for in CINCLANT OPLAN 314-61 be pared down to four days and that the five days provided for in CINCLANT OPLAN 316-61 be cut to two days. It was the former requirement for a rapid-reaction air-strike capability that was the genesis of CINCLANT OPLAN 312-62, the air-strike contingency plan.]

152. [The JCS conveyed the views of the Secretary of Defense regarding inadequacy of reaction times to CINCLANT, as well as the Secretary's directive for a rapid-reaction air-strike capability and for a reduction in reaction times of OPLANs 314-61 and 316-61.] Repeating the explicit terms of reference laid down by the Secretary, they instructed CINCLANT to prepare a plan providing for air strikes against specified categories of Cuban military targets in the following order of priority, and in accordance with the respective reaction times (from a condition of no warning) as indicated:



TOP SECRET

- 55 -

~~TOP SECRET~~

TOP SECRET

~~TOP SECRET~~

CINCLANT was further advised that the Secretary of Defense had stipulated that Navy and Air Force tactical aircraft, armed with conventional weapons only, were to be employed.<sup>1</sup>

E 111  
A 3

153. In the same message, the JCS informed CINCLANT of the Secretary of Defense's desire to have the reaction times of the two contingency plans under development reduced drastically. Relaying the Secretary's directive, they instructed CINCLANT to alter OPLAN 314-61 so as to provide for a four-day reaction time and modify OPLAN 316-61 to two days.<sup>1</sup>

154. To fulfill the new planning requirements, CINCLANT, as a first step, ordered the immediate activation of Joint Task Force 122 on 27 January 1962. At the same time, he provided his subordinate commands, and other commands directly concerned (CINCSTRIKE, CG CONARC, and COMFAC), with the necessary planning guidance in accordance with the terms of reference laid down by the Secretary of Defense and amplified by JCS. He instructed the commanders of the Air Force Task Force and the Naval Task Force of Joint Task Force 122 to be prepared to conduct tactical air strikes against designated targets as directed by CJTF-122. To this end, he requested them to submit estimates of aircraft requirements to achieve the air-strike capability described by the Secretary of Defense, as well as prepositioning requirements therefor, on the basis of TAC aircraft being responsible for the area west of longitude 79 W (running approximately through the middle of Cuba) and naval aircraft for the area east of it. He also requested specific information on the estimated cost of such an air-strike capability and its effect on other major plans and programs.

<sup>1</sup>Message JCS to CINCLANT, JCS 3385, 020012Z, January 1962, TOP SECRET.

<sup>2</sup>Ibid. ]

TOP SECRET

- 55 -

~~TOP SECRET~~

TOP SECRET

~~TOP SECRET~~ E

[155. As part of the same action, CINCLANT also apprised his subordinate Service component commanders of the second requirement of the Secretary of Defense transmitted by JCS, [namely cutting down the reaction time of CINCLANT OPLAN 314-61 to four days and CINCLANT OPLAN 316-61 to two days.] CINCLANT informed them that in order to achieve such a readiness posture he was prepared to authorize certain alerting and prepositioning of forces, including actual advance deployment of some amphibious and seaborne units. He accordingly instructed them to review their respective supporting plans for 314-61 and 316-61 and submit specific information on the following:

a. Estimates of alerting and prepositioning requirements to attain a [four-day reaction time for OPLAN 314-61 and two days for OPLAN 316-61.]

b. Estimates of the length of time such a readiness state could be maintained.

c. Estimates of costs, and of the impact on other major plans and programs, resulting from such reduction in lead-time.<sup>1</sup>

156/ From then on CINCLANT, as well as other commanders affected, was preoccupied with the problem of trying to meet the quick-reaction criteria set by the Secretary of Defense. Planning for the rapid-response, air-strike capability progressed relatively smoothly, culminating in what was eventually to become CINCLANT [OPLAN 312-62, but the attempt to revise invasion plans to provide for such drastically reduced lead-times as the Secretary had imposed proved another matter.]

[Message, CINCLANT to CJTF-122, USARLANT, USAFLANT, CINCLANTFLT (Info: CINCSTRIKE, CG CONARC, COMTAC), 292214Z January 1962, TOP SECRET.]

TOP SECRET

- 57 -

~~TOP SECRET~~

L

~~TOP SECRET~~

TOP SECRET

[ 157. [CINCLANT held a conference on 7-8 February 1962 with commands concerned to discuss the Secretary of Defense's requirements. On 24 February CINCLANT responded to the JCS directive of 2 January containing the terms of reference. As a result of the conference, an outline for the required air-strike plan had been produced, which was submitted as part of CINCLANT's response. [But with regard to reducing lead-times in the contingency plans, he expressed concern over the risks involved in any invasion plan calling for such a short reaction time from a nonreadiness posture, with no prior notice or preparations. Therefore, he included a list of requirements in detail, including overflights for vertical aerial photography and execution of selected portions of Phases I, II, and III of OPLAN 314-61 (alerting, prepositioning, redeployment, and other preparatory actions). In addition, the forces earmarked for the air-strike plan and the invasion plan -- and their requirements -- were listed by Service.] However, CINCLANT informed JCS of other significant results of the conference. Emerging from the deliberations was the question of whether OPLAN 316-61 was any longer adequate to cope with the current estimated strength of the Cuban armed forces and their apparent continual growth. In the light of this appraisal, and in view of the new requirements for rapid-reaction air-strike capability and for OPLAN 314-61 to have a [four-day] reaction time, the conference had concluded that further development of OPLAN 316-61 might not be necessary.]

B1 A1  
AS

158. [In another message to JCS on the same day, CINCLANT was more explicit, stating that he "strongly recommends that]

[Message, CINCLANT to JCS, 241554Z, Feb. 1962, TOP SECRET.]

TOP SECRET

- 58 -

~~TOP SECRET~~



[316-61 be canceled." He gave as reasons that the forces earmarked for initial employment in 316 were considered to be of marginal strength in relation to Cuban armed forces capability, whereas readying and prepositioning measures for 314-61 would not only achieve the reaction time desired but would also provide adequate forces.] |

D111  
75

159. In the JCS reply a month later, on 27 March 1962, CINCLANT was instructed to continue developing OPLAN 316-61 in accordance with the latest terms of reference of the Secretary of Defense (two-day reaction time), but simultaneously to develop modifications of it based on advance preparedness and on increased reaction time.<sup>2</sup> In effect, this set in motion a new cycle of planning, amounting to two new sets of quick-reaction plans over and above the basic 316 plan. Consequently, there was no final version settled upon, and OPLAN 316-61, as such, never did receive formal JCS approval, other than de facto acceptance for planning purposes only.

160. As a consequence of the JCS instruction of 27 March, a [two-day] reaction version of OPLAN 316 was eventually produced by CINCLANT to comply with the earlier directive of the Secretary of Defense. Rather than being developed as a separate formal plan, it was included as a somewhat incidental supplement to the 316 plan proper, being provided for in Annex "G". It was based on the assumption that there would be considerable prior warning and, indeed, that some of the forces involved would have even been prepositioned beforehand.<sup>3</sup>

<sup>1</sup>Message, CINCLANT to JCS, 241604Z, Feb. 1962, TOP SECRET.

<sup>2</sup>Message, JCS to CINCLANT, JCS 3806, 272100Z, March 1962, TOP SECRET.

<sup>3</sup>CINCLANT Historical Account of Cuban Crisis - 1962 (U), - 29 April 1963, TOP SECRET.

TOP SECRET

~~TOP SECRET~~

L  
B111  
AS

[ Intensive development of the planning details was apparently not pressed by either CINCLANT or JCS, for it barely evolved beyond the outline stage before being abandoned when the [two-day] reaction requirement was overtaken by new terms of reference. At no time did the [two-day] reaction plan contained in Annex "G" reach, in form or status, anything approaching a complete, approved operation plan. ]

151. [ In August, the generally increasing Cuban military capabilities, which had been observed earlier, now became more apparent and an appreciation of their tactical significance to any contemplated U.S. military action more conclusive. Signs pointing to a considerable improvement in Cuba's hitherto rudimentary air-defense capability were particularly disturbing. By early September recognition of the extent of the improvement, in quality and quantity, injected fresh impetus into planning, lending especially a new point and urgency to the requirement for air-strike plans. Responsibility for preparing the actual substance of the air-strike plan that had been directed by the Secretary of Defense the preceding January fell largely upon COMTAC/CINCPACFLT, as the commander most directly involved in such operations. On 7 September COMTAC formed a special staff planning group expressly charged with developing a detailed air-strike operation plan based on CINCLANT's concept and outline that had originated the previous March. Before the month was out, a proposed operation plan, nicknamed "ROCK PILE," was produced. CINCSTRIKE's concurrence had been obtained on 11 September; and on 27 September the Chief of Staff USAF reviewed and approved it, directing COMTAC to submit it to CINCLANT as a fully coordinated USAF plan. The following day CINCLANT, upon being briefed on the plan by COMTAC/CINCPACFLT, accepted it as the basis for the ]

TOP SECRET

- 50 -

~~TOP SECRET~~

TOP SECRET

CINCLANT air-strike operation plan, and on 1 October ROCK PILE was officially designated as CINCLANT CFLAN 312-62 (Cuba).<sup>1</sup> The plan was still far from completion and work continued on it both at CINCLANT and COMTAC.

162. Throughout the spring and summer of 1962, the scope of planning activity in connection with the various contingency operation plans under development became all-pervasive. Pre-occupied in it were not only CINCLANT, who had overall responsibility, but also the three Service component commanders under LANTCOM (USARLANT, USAFLANT, CINCLANTFLT), plus CJTF-122 and the three Service Task Forces under CJTF-122, the JCS, the Services, the Service commands directly affected (CONARC, COMTAC, CINCSTRIKE), the subordinate tactical units that were to carry out the operation, and finally, the combat support and logistic organizations. The complexity of all the planning coordination that this involved was further complicated by a changing "enemy situation."

E. GUANTANAMO REINFORCEMENT PLANNING

163. One of the specific immediate problems posed by the improving Cuban capability was defense of the U.S. Naval Base at Guantanamo. There was mounting concern over the potentially inviting vulnerability of the Base in relation to growing Cuban ground strength. On 17 September, the JCS instructed CINCLANT to prepare, in coordination with CINCSTRIKE, special plans beyond existing plans for prompt reinforcement of

<sup>1</sup>USAF Historical Division Liaison Office, "Chronology of Air Force Actions During the Cuban Crisis, 14 October - 30 November 1962," TOP SECRET.

TOP SECRET

~~TOP SECRET~~

TOP SECRET

Guantanamo in anticipation of an expected attack and in the event of actual attack triggering implementation of OPLAN 314/316.<sup>1</sup>

164. CINCLANT responded on 26 September 1962 with a request for the 5th Marine Expeditionary Brigade (one regimental landing team, one air group, and associated amphibious assault lift), then assigned to CINCPAC and stationed on the West Coast, to be made available to LANTCOM for the required Guantanamo reinforcement. As an alternative, if this were not possible, he proposed using STRICOM forces (two airlifted airborne battle groups) that were scheduled for another mission in OPLAN 314/316. CINCLANT cautioned, however, that the use of STRICOM or LANTCOM forces for such augmentation of Guantanamo defenses would be at the expense of subsequent Cuban contingency operations as then planned.<sup>2</sup> On 8 October, when JCS forwarded to CINCLANT a Secretary of Defense request for readiness requirements to meet Cuban contingencies.<sup>3</sup> CINCLANT in his reply the same day reiterated his requirement for the 5th MEB from PACOM. In addition, he requested withdrawal of the PHIBRON and Battalion Landing Team then deployed in the Mediterranean.<sup>4</sup>

165 JCS queried CINCPAC, CINCEUR, and CINCNELM for their views on CINCLANT's request.<sup>5</sup> CINCPAC reluctantly agreed to

<sup>1</sup>Message, JCS to CINCLANT, (Info CINCSTRIKE), JCS 6148, 17 September 1962, TOP SECRET.

<sup>2</sup>Message, CINCLANT to JCS, 261922Z, September 1962, TOP SECRET.

<sup>3</sup>Message, JCS to CINCLANT, JCS 6590, 8 October 1962, TOP SECRET.

<sup>4</sup>Message, CINCLANT to JCS, 081916Z, October 1962, TOP SECRET.

<sup>5</sup>Message, JCS to CINCPAC, JCS 6625, 10 October 1962;  
Message, JCS to CINCEUR and CINCNELM, JCS 6620, 10 October 1962, TOP SECRET.

TOP SECRET

- 52 -

~~TOP SECRET~~

TOP SECRET

~~TOP SECRET~~

make the 5th MEB available to CINCLANT, despite the fact that this would seriously degrade certain of PACFLT's capabilities, but recommended against any redeployment of these forces until actually needed.<sup>1</sup> CINCEUR and CINCNELM, however, both recommended against withdrawal of the requested forces then deployed in the Mediterranean, since their presence was crucial to executing CINCEUR and CINCNELM contingency plans.<sup>2</sup>

166. The JCS took the issue under formal consideration, generating a "JCS Green" on it on 12 October. The JCS decided that the 5th MEB should be deployed temporarily from the West Coast to the Caribbean area but that the PHIBRON and BLT in the Mediterranean should not be withdrawn.<sup>3</sup> They were in the process of so recommending to the Secretary of Defense when the whole matter was overtaken by the event of the Cuban crisis, itself, and the original planning proposal calling for reinforcement of Guantanamo defenses became a requirement of immediate operational urgency. The problem encountered in fulfilling the requirement will be discussed in detail elsewhere.

167. Through September, reflecting a growing awareness of the extent of the Soviet-sponsored build-up in Cuba, there were other reactions affecting contingency planning. One of the most serious aspects of the build-up was the relatively sophisticated nature of some of the weaponry being furnished Cuca, particularly C-band radar and air and coastal missile-defense systems. The Chairman, JCS, informed CINCLANT of U.S. concern over the gravity of these developments

<sup>1</sup>Message, CINCPAC to JCS, 110920Z, October 1962, TOP SECRET.

<sup>2</sup>Message, CINCNELM to JCS, 101721Z, October 1962; Message, CINCEUR to JCS, 111610Z, October 1962, TOP SECRET.

<sup>3</sup>JCS 2304/68 (with Enclosure), 12 October 1962 (revised 15 October 1962), TOP SECRET.

~~TOP SECRET~~

TOP SECRET

and advised him to take measures to insure that his contingency plans and capabilities keep pace with the changing enemy situation. On 19 September, CINCLANT apprised the Chairman of the actions he had directed to be taken in the light of increased Cuban defensive capabilities. CJTF-122, CG XVIII Airborne Corps, Commander Amphibious Forces Atlantic (COMPHIBLANT), CG Fleet Marine Forces Atlantic (CGFMFLANT), and Commander 19th Air Force were instructed to review for adequacy the "complete family" of plans for Cuba. They were also requested to consider the possibility of requirements to conduct other operations corollary to those provided for in existing plans, such as deception and electronic or unconventional warfare, which might contribute to accomplishing their respective combat missions. CINCLANT reported, too, that targeting of Cuba was continuing to receive the highest priority and was being kept current of latest intelligence. He had, furthermore, called a conference, to be held on 2 October, of the senior commanders who would be involved in planned contingency operations, in order to discuss fully the tactical implications of the new Cuban developments.<sup>1</sup>

168. Concern over these tactical implications of the Soviet military build-up in Cuba also reached the White House. The President was especially apprehensive about U.S. losses expected in attacking SA-2 missile sites. On 21 September, he requested the Secretary of Defense to make sure that contingency plans for Cuba were kept up-to-date so as to take into account "additions to their armaments resulting from the continuous influx of Soviet equipment and technicians."<sup>2</sup> Action

<sup>1</sup>Message, CINCLANT to JCS (Exclusive for Chairman), 192318Z, September 1962, TOP SECRET.

<sup>2</sup>Memo, President to SecDef (no subject), 21 September 1962, TOP SECRET.

TOP SECRET

- 54 -

~~TOP SECRET~~

~~TOP SECRET~~

TOP SECRET

on the matter was referred by the Secretary of Defense to the JCS, and on 1 October 1962, the Chairman, JCS, submitted a draft response to the Secretary based in large part on CINCLANT's earlier comments, the substance of which was forwarded to the President on 4 October. In it the President was reassured that the "complete family" of contingency plans for Cuba "is constantly being reviewed, revised and updated by the Joint Chiefs of Staff, Commander-in-Chief, Atlantic and appropriate subordinate commanders to counter the changing capabilities of the Cuban forces."<sup>1</sup>

F. BLOCKADE PLANNING

159. Meanwhile, the Joint Strategic Survey Council (JSSC) had undertaken, at JCS request, a study of the strategic implications of the Soviet build-up of Cuban military capability. The resulting JSSC report, dated 19 September, concluded that the situation had reached a point where the use of armed force was now needed, prior to Cuban attainment of an offensive capability to threaten U.S. vital interests and before Soviet vital interests became involved. The Council was particularly apprehensive about the possibility of a Soviet MRBM or submarine atomic capability being established in Cuba. In the present circumstances and prospects, it saw only two courses of action for the U.S.: invasion or blockade. Although the tenor of their position was in favor of invasion, they pointed out that a blockade, if continued long enough, would starve out Cuba and forestall further Soviet delivery of arms of all types.<sup>2</sup>

<sup>1</sup> Attachment to Memo, CJCS to SecDef, CM-990-62, "Presidential Interest in SA-2 Missile Systems and Contingency Planning for Cuba (C)," 1 October 1962; Memo, SecDef to President, same subject, 4 October 1962, TOP SECRET.

<sup>2</sup> JCS-2304/58, 19 September 1962, TOP SECRET.

TOP SECRET

- 55 -

~~TOP SECRET~~

~~TOP SECRET~~

TOP SECRET

170. The JSSC report was not adopted as a formal JCS position paper, but its conclusions with respect to a blockade were apparently conveyed to CINCLANT and precipitated a fresh round of planning activity. CINCLANT OPLAN 314-61 and 316-61, as well as plans in support of them, had contained passing references to a possible blockade of Cuba incidental to the main operations provided for. These references, however, hardly constituted a detailed plan for a blockade operation as such. Therefore, on 21 September, CINCLANT issued Planning Directive 118-62 calling for contingency planning preparations for a blockade of Cuba.<sup>1</sup>

171. The Planning Directive's assumptions stated, "A blockade of Cuba could bring Cuban economy to a standstill in relatively short time," and would be "particularly disastrous with respect to POL." Its statement of the mission was "...when directed, conduct a naval and air blockade of Cuba in order to bring about a collapse of the Communist economy of Cuba." CINCSTRIKE would provide the forces, but CJTF-122 would exercise operational control of them.<sup>2</sup> Within a month CJTF-122 developed Annex "Q" to his CJTF-122 OPLAN 314-61 and 316-61, which provided for establishment of a sea and air blockade of Cuba as directed.<sup>3</sup>

172. The resulting blockade plans, however, proved inapplicable during the crisis. They were predicated upon complete blockade, both sea and air; the "quarantine" that was the actual course of action decided on was limited, selective, and restricted to surface ships only. An appropriate new plan had to be improvised later on the spur of the moment.

<sup>1</sup>Message, CINCLANT to CINCLANTFLT, CJTF-122, at al, 212136Z, September 1962, TOP SECRET.

<sup>2</sup>Ibid.

<sup>3</sup>Appendix "A" to Enclosure to JCS 2304/69, 14 October 1962, TOP SECRET.

TOP SECRET

- 56 -

~~TOP SECRET~~



2111  
A5

REAPPRAISALS OF CONTINGENCY PLANNING

173. [By the end of September, the state of contingency operations plans under development was beginning to become both confusing and unmanageable. Their number and variety had grown somewhat unsystematically, with no assurance of comprehensiveness. Moreover, circumstances and objectives had changed from the relatively simple, clear-cut purposes that had initially motivated the contingency planning. On 1 October, at a meeting of the Secretary of Defense with the JCS, the question was raised as to the kinds of contingencies under which military operations against Cuba might be necessary. Some explicit political terms of reference regarding goals and objectives, the JCS felt, were desirable as a guide to what military planning should address itself.]

174 [The following day, October 2, the Secretary of Defense responded with a memorandum to the Chairman, JCS. He stated that U.S. national objectives in any contingency involving military action against Cuba would be either:

- a. "The removal of the threat to U.S. security of Soviet weapon systems in Cuba," or
- b. "Removal of the Castro regime and supplanting it with a new Cuban regime acceptable to the U.S."

175. [Conceding that the second objective was the more difficult, he pointed out that it might nevertheless be necessary if the first were to be secured permanently. The Secretary then described the gamut of likely circumstances under which military action might be required and toward which military]

<sup>1</sup>JCS 2304/64, 3 October 1962, TOP SECRET.

~~TOP SECRET~~

BIAI  
A'S

planning should be oriented, identifying the following list of six categories of contingencies:

- a. Soviet action against Western rights in Berlin where Western countermeasures would include a blockade of Cuba.
- b. Evidence of Communist Bloc positioning of offensive weapon systems in Cuba.
- c. Attack against the U.S. Naval Base at Guantanamo, or against U.S. planes or shipping outside Cuban territorial waters or airspace.
- d. A "substantial popular uprising" in Cuba against the Castro regime in which U.S. aid is requested by insurgent leaders.
- e. Cuban armed assistance to subversion in other parts of the Western Hemisphere.
- f. A Presidential decision that the Cuban situation has "reached a point inconsistent with continuing U.S. national security."

He requested JCS views on the appropriateness and completeness of this list.

175. In the same memorandum the Secretary of Defense also asked the JCS to provide answers to the following:

- a. The military operational plans considered suitable for each contingency listed above.
- b. The preparatory actions that should be taken now and progressively in the future to improve U.S. readiness to execute these plans.
- c. The impact of U.S. actions taken in Cuba on U.S. force and logistic capabilities for meeting contingencies in other areas of the world, i.e., Berlin, Southeast Asia, etc.

Memo, SecDef to CJCS, no subject, 2 October 1962, TOP SECRET.

Ibid.

~~TOP SECRET~~

TOP SECRET

~~TOP SECRET~~ L

177. To help develop answers to the question regarding improving readiness posture, the JCS called a conference of operations and logistic planners of CINCLANT, CINCSTRIKE, and the Service Chiefs, who met in the Pentagon on 10 October. In the course of the discussions, the conference considered, besides readiness posture itself, most of the other points raised by the Secretary of Defense.<sup>1</sup> The views expressed and the consensus reached were taken into account in the staffing of the JCS response to the Secretary.

L21.11  
#3

H. PLANNED U.S. MILITARY CONTINGENCY POSTURE ON THE EVE OF THE CRISIS

178. In the process of preparing a response to the 2 October memorandum of the Secretary of Defense, the JCS produced a consolidated compendium summarizing the general planned U.S. military posture for dealing with a Cuban contingency as that posture was on the eve of the crisis. The basic JCS paper, staffed by J-3, was dated 14 October and received tentative JCS approval on 15 October. There was no final approval in the form of a "red band" decision-on, nor was the draft memorandum contained in its enclosure forwarded, inasmuch as by this time the entire matter was being overtaken by events.<sup>2</sup> Its substance, however, was conveyed informally to the Secretary of Defense in various conferences, briefings, and consultations immediately attending the first reactions to the crisis.

179. First of all, on the recommendation of CINCLANT, a seventh contingency was added to the six listed by the Secretary of Defense, namely, "Raids on the United States"

<sup>1</sup>"CINCLANT Historical Account of Cuban Crisis, 1962 (U)," 28 April 1963, TOP SECRET.

<sup>2</sup>JCS 2304/65, 14 October 1962 (N/H, 15 October 1962), TOP SECRET.

TOP SECRET

- 59 -

~~TOP SECRET~~

TOP SECRET

Then each of the three basic contingency plans was described, along with their individual functional characteristics and limitations, and the interrelationship between them explained.

180. OPLAN 312-62, the air-strike plan, could be conducted alone or serve as an opening step to be followed by execution of OPLAN 314-61 or 316-61, but in the JCS view, if a contingency were serious enough to require implementation of the 312 plan, it would also require initiation of the 314/316 invasion plans. The planned force commitment provided for in OPLAN 312-62 was:



JCS 2304/69, 14 October 1962 (N/H, 15 October 1962), TOP SECRET

TOP SECRET

~~TOP SECRET~~

181. This would make available for operational employment a total of approximately [470] naval and Air Force aircraft within [24 hours] of an order to execute the plan. OPLAN 312-62, the JCS felt, could be conducted with minimal losses, based on the estimated enemy capability for the next 6 months. It would accomplish the first national objective stated by the Secretary of Defense: to remove a military threat to U.S. security posed by Soviet offensive weapon systems in Cuba. /

182. Separately allocated under the provisions of Guantanamo reinforcement plans was [one] Marine Battalion Landing Team (BLT) from the Caribbean amphibious squadron (CARIB PHIERON) and [one] Marine Battalion to be airlifted from CONUS. /

183. [OPLAN 314-61 and 316-61 were next outlined, with the reaction time of the former indicated as being 18 days and that of the latter as 5 days. There was no mention of the 4-day and 2-day reaction times that the Secretary had demanded earlier. Either of these plans would also accomplish, besides the first national objective above, the second one of removing the Castro regime and supplanting it with a new Cuban government acceptable to the U.S. The magnitude and phasing of the force commitment provided for in 314-61 was considered adequate to lend high assurance of success against the present Cuban capability, but 316-61, although providing ultimately for the same magnitude of force commitment, involved risks concomitant with the slower incremental phasing and build-up of forces in Cuba.]

184. [The planned force commitment provided for in 314/316-61 constituted the "overwhelming force" required by the President's original terms of reference laid down in April 1961. In addition to including all of OPLAN 312-62 and Guantanamo augmentation forces listed above, it was to be composed of the following:]

~~TOP SECRET~~

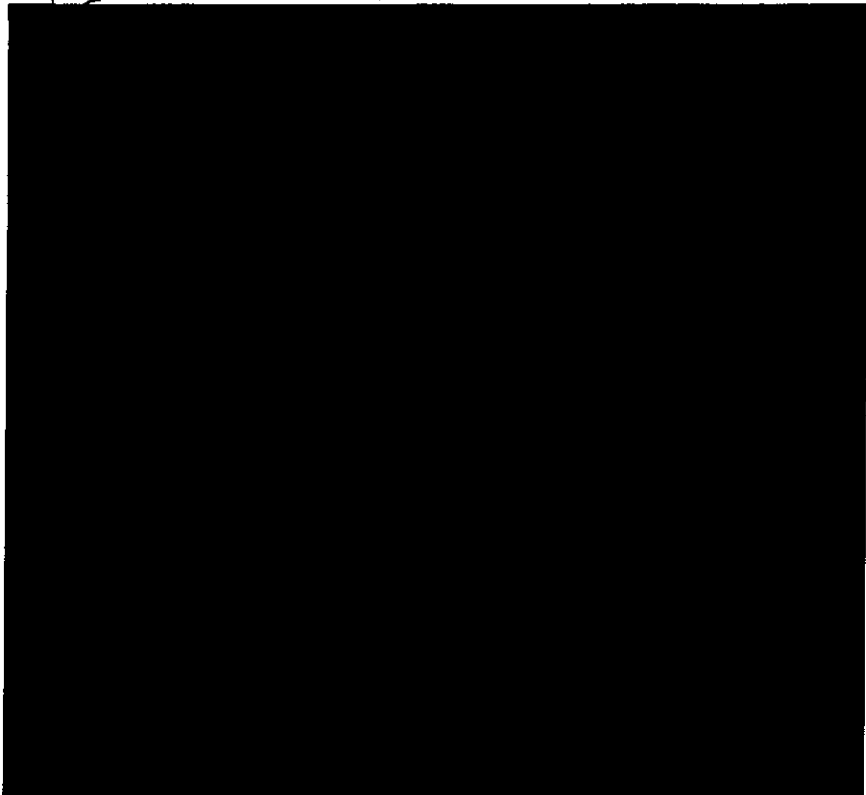

11/1  
A 5

135. Some preparatory measures, it was pointed out, had been taken by the Services to improve readiness posture. Among these were repositioning of POL, ammunition, and other expendables by the Navy and Air Force at bases in southeastern U.S., preloading of supplies in amphibious shipping by the Navy and Marine Corps, and positioning of accompanying supplies and equipment for Army assault forces at or near home stations by the Army. Constraints upon further reduction of reaction times, the JCS pointed out, were primarily those imposed by budgeting considerations. Significant reductions in reaction time could be effected by taking certain other preparatory measures to improve readiness, if a raise in budget ceilings permitted. These were: repositioning of units with their equipment and supplies, construction of staging facilities, requisitioning a large number of merchant ships, and mobilization of Air Force Reserve Units. ]!

TOP SECRET

E  
11/11/62

196. Finally, in response to the Secretary's request for JCS views on the effects elsewhere of U.S. military action against Cuba, the JCS paper had concluded that the following military consequences could be expected:

a. If the U.S. imposed a blockade on Cuba, it would have little direct military effect on U.S. posture in Berlin or Southeast Asia, but would have major international political ramifications, "as it constitutes an act of war," and would thus result in increased DEFCON status of U.S. forces worldwide.

b. If OPLAN 312-62 were executed, it too would not affect U.S. military posture in Berlin or Southeast Asia (other than increasing DEFCON status), but there would be serious political repercussions, Soviet reaction to which could not be foreseen.

c. If OPLAN 314-61 or 316-61 were executed, the JCS assessment of the military effect was:

(1) Adequate airlift to Europe and Southeast Asia would not be available for an estimated 8 days, beginning with D-5.

(2) Airlift within EUCOM, PACOM, and CARIBCOM would be "severely restricted" if C-130 aircraft were withdrawn to CONUS, as presently envisaged, instead of calling up Air Force Reserve C-119 aircraft.

(3) Thirty percent of cargo shipping and seventy percent of passenger shipping in the Atlantic presently under U.S. control would be required for a period of 30 days.

(4) Force augmentation plans for EUCOM and PACOM could not be fully carried out until termination of major combat operations in Cuba. ]

Appendix "A" to Enclosure to JCS 2304/6, 14 October 1962

TOP SECRET.

TOP SECRET

TOP SECRET

~~TOP SECRET~~

TOP SECRET

Notably, the JCS paper was dated 14 October 1962. In it there was no indication that U.S. military action addressed to Cuba might be expected to raise central strategic issues with the USSR as one of the principals.

187. Of the three basic contingency plans described above, only OPLAN 314-61 had been approved; the other two, 316-61 and 312-62, were still incomplete, either undergoing revision or being developed in several tentative versions. There was also the CJTF-122 contingency plan for sea and air blockade of Cuba. Besides these contingency plans, other existing plans that later proved to have intimate operational relevance to the crisis were the standing general war plans, such as those of CONAD for the defense of the U.S. mainland and the SIOP.]

188. This then represented a summation of the planned U.S. military posture to meet a Cuban contingency as of 15 October 1962, before events had yet revealed the nature of the contingency or national decision makers determined what response was in order. Preparation of the posture had been under way over a period of a year and a half and was still evolving. Embodied in the complex of plans that gave the posture its form were, inevitably, certain assumptions, commitments, and expectations, central to which was the anticipation of a military crisis calling for a forthright military solution./

189. The coming crisis indeed proved to be essentially a military one -- vital national security interests were threatened. However, the means directly employed to articulate the military issues, to achieve the military objectives and ultimately to resolve the military crisis were manifestly political-diplomatic measures. The ]

TOP SECRET

- 74 -

~~TOP SECRET~~



TOP SECRET

~~TOP SECRET~~

role of military action itself was always imminent but remained latent, and the task of maintaining the required delicate balance between the two devolved largely upon contingency planning.]

I. SUMMARY OBSERVATIONS

190. The precrisis contingency planning had begun, some 18 months before the crisis, with a crisply defined, single focus. It had been expressly initiated as a reaction to a specific event -- the ignominious Bay of Pigs fiasco. The original purpose was to devise a straightforward military operation plan to accomplish the explicit military objective of invading and subduing Cuba by U.S. forces. Gradually, as technical military considerations and policy desiderata injected qualifying ramifications, the planning became more complicated. The trend toward complexity increased with time and the original sharp focus progressively gave way to a multiple-perspective approach. New planning requirements tended to be cumulative.

191. [A major bifurcation in the planning had occurred a year before the crisis. It was the result of dissatisfaction at the national decision-making level with the speed of reaction being provided for to implement the invasion plan. As a consequence, eventually four categories of invasion planning, each oriented to its respective reaction time, were simultaneously underway. Two crystallized into separate, distinct invasion operation plans: OPLAN 314-61, based on 14-day lead time; and OPLAN 316-62, a quick-reaction version based on 5-day lead time. The other two categories, however, were not formally abandoned, but all four were actively being pursued with greater or lesser emphasis in parallel when the crisis came.]

TOP SECRET

- 75 -

~~TOP SECRET~~

TOP SECRET

~~TOP SECRET~~ B1  
A 1  
A. 5

192. [The second, and more important, bifurcation in the contingency planning occurred six months before the crisis as a result of the introduction of a new planning requirement for a different kind of contingency operation. It too reflected dissatisfaction on the national decision-making level with the best reaction times that military invasion planning had been able to achieve. In order to bring military force to bear more rapidly than in the form of invasion, planning was undertaken for large-scale air-strike operations against Cuba. The air-strike contingency plan, designated OPLAN 312-61, was independent of the 314/316 plans and could be executed either alone or be followed by implementation of the invasion plans.]

193. In addition to the several versions of contingency plans proper, a congeries of ancillary, subsidiary, and supporting plans, keyed to each operational course of action contemplated, was also undertaken to carry the planning to the necessary depth of detail.

194. [Dominating precrisis contingency preparations, and largely determining the character of the military plans produced, were the national assumptions regarding the nature and context of the expected contingency.]

195. [The entire complex of contingency plans had been predicated upon a simplified model of a classic contingency situation. It presumed a localized off-shore incident in which "police-action" measures would be brought to bear against a malefactor, in order to eliminate the source of provocation and restore order to the Caribbean community. Specifically, in this case, the only protagonists actively engaged would be the U.S. and Cuba, with the affected military arena containing itself to Cuban territory, and the ]

TOP SECRET

- 75 -

~~TOP SECRET~~

B1  
A1  
A5

attendant military action confined to conventional operations in a limited-war context. It further presupposed the tactical initiative to be a U.S. prerogative. Since the motivation was to be essentially preemptive, the exact timing, scale, and type of military action taken would be optional at the discretion of the U.S.

196. Not until the very eve of the crisis was the possibility raised, in explicit terms, that the nature and circumstances of a Cuban contingency could be quite different from what had been assumed. Less than two weeks before the crisis, the Secretary of Defense had apprised the JCS that vital U.S. interests might indeed be involved, when he advised that one of the national objectives might be "the removal of the threat to U.S. security of Soviet weapon systems in Cuba." This did not, however, bring about a fundamental reappraisal of planning requirements. The preparation of the JCS response, staffing of which was completed on the day of the reconnaissance photographs that precipitated the crisis, gave no particular emphasis to the strategic implications of such a national objective. Certainly the existing contingency plans themselves were not materially affected. Local operations addressed to Cuba were still viewed as comprehending the main military aspects of a Cuban contingency, with the Soviet factor peripheral or incidental.

197. A salient characteristic of all this planning activity was the generative source of impetus that set in motion most of the significant planning developments. The prime-mover force that initiated planning actions or subsequently re-directed their course was outside the military establishment. Every basic plan and alternate version of it came into being directly in response to a specific requirement expressly laid on by the President or the Secretary of Defense.

~~TOP SECRET~~ L

TOP SECRET

198. [A concomitant characteristic was that almost no substantive planning was done within the Organization of the Joint Chiefs of Staff. Typically, the bulk of the actual planning was performed at the LANTCOM level or below. The JCS relayed requirements and instructions received from the Secretary of Defense to CINCLANT, who in turn usually referred them to his appropriate Service component commander concerned. Since the Army and Air Force component commands of LANTCOM had not been activated and staffed as such, responsibility for conducting the planning devolved upon them in their other command capacities, namely as COMUSCONARC and COMTAC respectively. As Service commands, they coordinated their planning with their Service chiefs as much as with CINCLANT. In practice, thus, the JCS, and to some extent CINCLANT as well, had a largely passive, intermediary role as agents between the planning principals who originated and responded to planning requirements. The participation of the JCS was essentially post facto and confined to either delegation of planning tasks or authorization of the way the planning tasks were fulfilled.]

199. [Up to the time of the crisis, the status of individual elements comprising the complex of contingency plans was not uniform. The basic plans, alternate versions of them, and their organic components were in various stages of development. Some had been completed and formally adopted; others were pending, awaiting review and approval; and still others were only outlines of plans, or even were proposed concepts that had yet to be accepted. Most were in the formative stage of being drafted. A few had hardly gotten beyond the articulation of a planning requirement, then were not heard of again. Among these different planning elements, there sometimes was inconsistency, and occasionally contradiction. In the complex as a whole, there was no little ambiguity.]

TOP SECRET

- 78 -

~~TOP SECRET~~

TOP SECRET

TOP SECRET

200. [A corollary of the above characteristics, as demonstrated in the precrisis experience, was that the structure and functioning of military contingency planning was unsystematic. Its processes, rather than consistently following regular patterns of dependent interactions, were variable and unpredictable, with the key determinants impinging at random from outside. In short, there was no contingency planning system.]

TOP SECRET

- 79 -

TOP SECRET

~~TOP SECRET~~ 4

TOP SECRET

### III. THE U.S. BASIC DECISION

201. The formulation of U.S. policy in response to the Soviet stratagem in Cuba was a unique process, marked both by informality and effectiveness. It was completely within the White House purview, with the President taking part in every step of the process from which the policy finally emerged. This Executive decision-making process was almost textbook in its quality, and accordingly, the events of the critical week have received a phenomenal degree of public attention. While no actual White House records have been made available, either to the public or to this study, enough information has become public for an accurate picture to be drawn.

#### A. BACKGROUND CONSIDERATIONS

202. The U.S. had been generally aware of a Soviet-sponsored military buildup occurring in Cuba for some time before the crisis. During the summer and fall of 1962, Cuban contingency planning and intelligence operations covering the military buildup proceeded on parallel but essentially distinct paths. Without doubt, the results of the latter influenced the former, the growth of Cuban capability, for example, obviously bore a direct relationship to contemplated U.S. force requirements in the plans. The plans were based upon a U.S.-Cuban clash but the intelligence operations showed a continuing and increasing Soviet involvement. This fact changed the perspective of U.S. military action against Cuba, since it brought into the picture new and incalculable factors of significance going far beyond the Caribbean.

203. However, there had been a marked disinclination to believe the Soviets would be so rash as to base offensive nuclear weapons in Cuba. Indeed, regular classified intelligence sources that are normally circulated did not report any

TOP SECRET

- 80 -

~~TOP SECRET~~

~~TOP SECRET~~

LE  
BIAI  
AH  
AS

TOP SECRET

Indications to this effect, or even seriously entertained the possibility in their interpretation of Cuban military developments.<sup>1</sup> On the contrary, the Special National Intelligence Estimate (SNIE) of 19 September 1962, which expressly addressed itself to the military buildup in Cuba, was actually misleading. The burden of the conclusions contained in the Estimate were that the USSR's interest in Cuba was "primarily for the political advantages," that the military buildup was for purposes of Cuban defense, and that the Soviets were unlikely to introduce strategic offensive weapons systems into Cuba -- especially discounted was the probability of Soviet deployment of nuclear-armed missiles.<sup>2</sup> Undoubtedly as the crisis approached there were other, tenuous indications received which, because of their sensitivity, were extremely closely held and not reported in the circulated intelligence publications; but apparently these did not materially alter U.S. expectations, certainly not enough to trigger a fundamental reappraisal in time.]

204. U.S. policy posture thus was pointedly oriented away from a contingency such as would be posed by introduction of Soviet strategic missiles into Cuba. Consequently, when the event was suddenly recognized as having already occurred, it came as a surprise and a response had to be contrived on an ad hoc basis. A choice had to be made between the direct pursuit of the courses of action embodied in the contingency plans and some other less final course which took into account the Soviet presence in Cuba. Nevertheless, during the period of decision, from October 15 to October 22, steps were simultaneously put into effect to prepare to carry out the contingency.

with  
with

<sup>1</sup>Based on a systematic analysis of the pertinent NIEs and SNIEs issued in the six months prior to the crisis, all the CIA Current Intelligence Weekly Summaries for the period September-October 1962, and all DIA Intelligence Bulletins for the month preceding the President's speech (all SECRET).

<sup>2</sup>SNIE 85-3-62, "The Military Buildup in Cuba," 19 Sep 62, SECRET.

TOP SECRET

~~TOP SECRET~~

E  
D/14  
A5

plans in the event the ad hoc plan failed to accomplish its purpose. Although intelligence information on the Soviet buildup had begun to increase markedly in early summer, it was not until October 1 that routine peripheral photo reconnaissance missions around Cuoa were begun. In addition, high-altitude U-2 flights over Cuba were also flown, and it was by this covert means that the offensive threat was discovered.

B. THE DECISION-MAKING PROCESS

205. The U-2 photographs taken on October 14 were not available until late on the 15th, although CIA officials and others in the intelligence community had apparently been alerted to the tentative nature of the findings by about noon of that day. This information was relayed to the JCS and White House staff and to a small group of top officials of DOD and the State Department, but the President himself was not informed until 0900<sup>2</sup> on the 16th<sup>3</sup>.

206. Ordering increased surveillance of the whole island, the President organized a group of key advisors who would finally be the ones to thra: out a U.S. response. The body of advisors was eventually narrowed to a group of eight who later were constituted into an Executive Committee of the NSC

<sup>1</sup>CINCLANT Historical Account of the Cuban Crisis, 1962, TOP SECRET.

<sup>2</sup>Geographical discrepancies in time have been reconciled on the basis of greatest significance from the Joint Staff-NSC point of view. All times given in the text, except where indicated otherwise, have been converted to a common equivalent corresponding to the prevailing local time in Washington, whereas time references in footnote citations retain the original Greenwich Mean Time constant designated in terms of Z time. Because of "daylight saving time" being in effect during part of the crisis period, two time differentials between local Washington time and Z time must be taken into account: Eastern Daylight Saving Time, i.e., Q-time, which terminated at 0600Z, 28 October 1962, is Z-time minus four hours; Eastern Standard Time, i.e., R-time, to which local Washington time reverted as of 0600Z that date, is Z-time minus five hours.

<sup>3</sup>Chronology of the Cuban Crisis, October 15-28, 1962. Official publication (no date or source) based on information provided by the White House Press Office, DoD Office of Public Affairs, and the State Department Bureau of Public Affairs.



~~CONFIDENTIAL~~

but these constantly drew on the counsel and support of a wider group. The sole military member of this committee was the Chairman of the JCS. In total numbers, those who were informed of the critical situation were very few.<sup>1</sup>

207. The key element in the situation appeared to be the urgent nature of the clandestine Soviet move. The decision to station Soviet strategic forces outside the Soviet Union for the first time was a deliberately provocative gesture, an attempt to overturn swiftly and by surprise the existing nuclear status quo. It was felt that the Soviet move was undoubtedly tied to larger objectives than Cuba per se. It was all too clear that a sudden dramatic Soviet revelation of an operational capability in Cuba, coupled with a renewed effort to change the Berlin situation, would put the U.S. at a grave disadvantage. Arrant defiance of America with impunity would seriously undermine confidence in the U.S. among friends and Allies, while the missiles themselves would go far toward redressing the strategic equation in favor of the Soviets.

208. The extremely sinister nature of the Soviet move was highlighted by the deliberate deception practiced by the USSR. On September 11, the Soviets publicly stated that the armaments sent to Cuba were defensive only and that there was no need for the USSR to base its offensive forces overseas.<sup>2</sup> Again, during the critical week of decision making itself, Soviet Foreign Minister Gromyko personally assured the President, during their meeting on October 19, that Soviet assistance to Cuba "pursued solely the purpose

---

<sup>1</sup>Chronology of the Cuban Crisis, op. cit., page 2.

<sup>2</sup>New York Times, September 12, 1962.

~~CONFIDENTIAL~~

~~CONFIDENTIAL~~

of contributing to the defense capabilities of Cuba."<sup>1</sup> He said he had been explicitly instructed to make this clear once again, that the training by Soviet specialists of Cuban nationals in handling defensive weapons was "by no means offensive" and that "the Soviet Government would never become involved in rendering such assistance."<sup>2</sup>

209. Some confusion over objectives became evident at the first meeting of the Executive Committee. Some members thought the prime aim should be to get rid of the offensive weapons; others considered it necessary to remove the Castro regime.

210. The courses of action open to the President ran the gamut from passive acceptance of the Soviet coup to invasion of Cuba without warning. Intermediate steps possible included, in ascending order of forcefulness, a major effort of protest through the U.N., a blockade coupled with a demand for the removal of the offensive weapons, and a surprise air strike against these weapons. Combinations were possible, such as an ultimatum to be followed by invasion, or an air strike to destroy the offensive weapons accompanied by a blockade to prevent the introduction of further weapons.

211. Passive acceptance of the Soviet move or an equally useless protest were promptly discarded as courses of action, and discussion during the week concentrated on positive actions of greater or lesser violence.

---

<sup>1</sup>The Soviets were indulging in semantic chicanery in their use of the terms "defensive" and "offensive." For purposes of propaganda, they could claim the offensive weapons were there only as part of the defense of Cuba.

<sup>2</sup>New York Times, October 23, 1962.

~~CONFIDENTIAL~~

CONFIDENTIAL

212. Surprise invasion was soon ruled out for two reasons. In the first place, the effect might be so startling as to provoke the Soviets into an almost automatic reflex countermove in which lay the grave possibility of escalation to general war. Secondly, there was the problem of timing. It was apparent that a decision would have to be reached and a course of action implemented within a few days, since the Soviet missiles would very soon be fully operational. If this occurred before the U.S. action had been launched, our move would become a countermove, all the advantages of catching the Soviets by surprise would be lost, and the Soviets would be compelled to more strongly defend their position in Cuba, especially if its presence had previously been announced to the world. In view of the length of time necessary to prepare an invasion and the scale of the operations involved, surprise would almost certainly be lost. Furthermore, the moral factor counted heavily against both forms of surprise attack.

213. By Thursday, October 18, discussions in the Executive Committee began to center on the use of a naval blockade. The disadvantages of this alternative were perhaps more glaring than its advantages. It would not per se dismantle the missile bases and remove the weapons; unfavorable repercussions among maritime nations, especially within NATO, might be severe; it might be necessary to sink Soviet ships if the Soviets chose to challenge the blockade, the natural Soviet riposte appeared to be a counterblockade of Berlin, with all the potentialities in this; finally, a blockade might not take immediate effect, and by prolonging the crisis, could permit the Soviets more time to counteract. Furthermore, the longer the crisis lasted, the more likely would it become that a clash with Soviet ships or personnel would occur.

214. The most attractive feature of the blockade, on the other hand, lay in the fact that it was not irrevocable.

CONFIDENTIAL

~~CONFIDENTIAL~~

Coupled with a stern warning, and accompanied by obvious preparations for direct military action against the island, blockade would still leave the Soviets the possibility of withdrawal without leaving a record of American, Cuban, and Russian dead. The restrained nature of the U.S. response, once the full extent of the Soviet duplicity was revealed to the world, would be more likely to gain the political support we wished to use as pressure against the Soviets. The door was left open for peaceful solution.

215. To be sure, if the blockade were to fail in its purpose, the Soviets would have time to develop a countermove somewhere, as well as to get their missiles operational. However, the U.S. would also have time to marshal its forces for invasion. We would then be in a position to raise progressively the degree of pressure at will, without having initially thrown our whole hand down on the table.

216. The choice thus was between the competing demands of measured restraint and time.

G. THE COURSE OF ACTION ADOPTED

217. By Saturday, October 20, a consensus of the Executive Committee had been reached; and that afternoon, after a detailed intelligence briefing which illustrated the rapidly advancing state of work at each missile site, the President tentatively decided that the U.S. course of action would be a blockade. Ultimately called a quarantine, it would be coupled with a warning to the Soviet Union and a demand for removal of the offensive weapons. The U.S. case would simultaneously be taken to the U.N. Security Council. The President would announce the U.S. policy in an address to the American people during the evening of the 22nd. The quarantine would be instituted as quickly as possible, taking into account the need to notify Allies and to permit necessary military preparations.<sup>1</sup>

---

<sup>1</sup>New York Times, November 6, 1962.

~~CONFIDENTIAL~~

~~CONFIDENTIAL~~

218. In the event of a security breach, the possibility remained of acting sooner.

219. In the meantime preparations for the execution of contingency plans for Cuba would continue. Forces would be gathered, prepositioned and readied, but no "execute" date would be set for assault.

220. Arrangements, to be described in detail elsewhere in this study, were made to inform and coordinate with allied states, especially in NATO and in Latin America, just prior to or simultaneously with the President's address.

221. The President's statement at 1900, October 22, described the nature of the Soviet move, the U.S. determination to block it, and a program of action designed to that end. The seven points encompassed were:

a. Imposition of a quarantine on Cuba to halt the further introduction of offensive equipment, the quarantine to be extended to other types of cargo and carriers if needed.

b. Increased close surveillance of Cuba.

c. The regarding of any nuclear missile launched from Cuba against any nation in the Western Hemisphere as an attack by the Soviet Union on the United States, requiring a full retaliatory response upon the Soviet Union.

d. Evacuation of dependents from Guantanamo and reinforcement of the base.

e. The calling of an immediate meeting of the OAS to consider the threat.

f. The calling of an emergency meeting of the Security Council of the U.N. and the presentation of a resolution demanding the prompt dismantling and withdrawal of all offensive weapons in Cuba under U.N. supervision before the quarantine would be lifted.

~~CONFIDENTIAL~~

~~CONFIDENTIAL~~

g. A personal call upon Premier Khrushchev to halt and eliminate the threat to the peace involved in the Russian moves.<sup>1</sup>

222. A copy of the President's address and a personal letter to Premier Khrushchev were sent to Moscow for delivery by the U.S. Ambassador just at the time the President was to speak. In Washington the Soviet ambassador had been summoned to the Secretary of State's office at 1800 hours on the 22nd where he met with the Secretary and a group of senior officials for half an hour, at which time he also was given a copy of the statement the President was about to make.

223. Shortly after the President's address to the nation on October 22, the State Department sent to all Embassies and Posts an amplification for use in dealing with local governments. It sketched out the rationale behind the seven-point program, attempting to anticipate reactions to it, and providing ammunition to meet those reactions.

224. The message emphasized that for discussions with foreign governments the restrained nature of the U.S. program should be stressed. Minimum force would be used to accomplish the U.S. objective in the quarantine in order to provide maximum opportunity to get a peaceful settlement. The President's final remarks were meant to indicate that the U.S. was receptive to proposals for a high-level meeting with the Soviets.

225. The objective of the U.S. was to obtain dismantlement of the offensive facilities. This would be sought in a

---

<sup>1</sup>New York Times, October 23, 1962.

~~CONFIDENTIAL~~

~~CONFIDENTIAL~~

resolution to the U.N. Security Council. If the Soviets vetoed this resolution and did not begin to remove the weapons, the issue would be taken to the General Assembly. In the meantime the operational portions of the President's program would be pursued.

226. The OAS Council would be asked on the morning of October 23 to constitute itself into a consultative committee under the Rio Treaty, and the U.S. would then present it with a resolution embodying the President's seven points for approval. It was expected that majority support would be obtained. However, the message stressed that the U.S. looked upon the action as a use of force to meet a threat to the peace and that the legal basis for the quarantine did not depend upon OAS approval, but rather on the inherent right of self-defense. The U.S. did not regard the quarantine as an act of war, and the message cited Article 2(3) of the U.N. Charter as authorizing the OAS to consider the threat to the peace posed by the Soviet military capability in Cuba. The U.S. considered the quarantine as a sanction appropriate within the OAS framework.

227. The message distinguished between a quarantine and a blockade, pointing out that while the former does have some elements of the latter, the latter is usually associated with the conduct of war. In this case, the quarantine was to be applied for purely defensive reasons.

228. The message reassured U.S. representatives that the U.S. was prepared for repercussions anywhere in the world. In regard to Berlin, it was noted especially that there were available comprehensive contingency plans ready for implementation.

~~CONFIDENTIAL~~

~~CONFIDENTIAL~~

229. To questions regarding an alleged parallelism between Cuba and the arrangements the U.S. has under NATO for positioning IRBM's in Italy and Turkey, U.S. representatives were to draw a sharp distinction, pointing out that the missiles in Italy and Turkey had been installed as a result of the decision of the NATO Council at the December 1957 meeting of the Heads of Government in Paris. The action was publicly announced and was taken in response to repeated Soviet threats that they had medium- and intermediate-range missiles and were ready to use them.

230. Partially to meet any objections to the unilateral character of the U.S. move, the message emphasized that all Allied Governments had been advised and informed beforehand. This warning had been supplemented by comprehensive briefings just prior to the President's speech for all NATO, OAS, SEATO, and CENTO mission chiefs here, as well as for national missions.<sup>1</sup>

231. This, then, was the policy adopted by the United States. It now remained both to await the Soviet and Cuban reactions (these might not be synonymous) and to prepare further measures toward gaining our objectives if the Soviets chose to ignore the quarantine and its associated steps. These further measures included not only those necessary to implement the quarantine and to prepare to implement contingency plans for attack against Cuba, but also to adopt the strongest deterrent posture against the possibility of general war.

---

<sup>1</sup> Department of State, Circular Telegram 725, October 22, 1962, UNCLASSIFIED.

~~CONFIDENTIAL~~



IV. POLICY COORDINATION: OVERSEAS UNIFIED  
COMMANDS AND ALLIED POWERSA. THE STRATEGIC CONTEXT

232. The American action against Cuba in October 1962 was planned and launched without any prior concert of Allied states. The absence of consultation was a consequence both of the unique sensitivity of the circumstances and of the shortness of time available for the development and implementation of an effective American response to the Soviet thrust. However, once that response was prepared and launched, it became a matter of major concern to coordinate the action with Allied states, primarily in Latin America and in Europe.

233. There was need, in the first place, to gain political support of an action by which the United States hoped to achieve its objective through the use of limited military force plus political pressure. If this combination were to fail, political support and sympathetic understanding would be highly useful when direct assault on Cuba was undertaken.

234. In addition to the political motivation, there were military ones. The first concerned Latin America and the danger possibly arising from revolts against the several governments to whose assistance the U.S. then would have to go. The second was based upon the potential danger of a Soviet riposte to the U.S. action in the form of moves against U.S. interests elsewhere in the world, especially in Europe. The possibility of the development of a general war could not be discounted.

235. This coordination with Allied states took several forms and raised a variety of problems for the U.S. national decision makers. The more important of these will be examined in this chapter.

~~TOP SECRET~~

~~TOP SECRET~~

236. There was, furthermore, a second and complementary aspect to the problem of coordination which requires joint examination. This was primarily a U.S. military command problem, involving the overseas Unified Commands.

237. The intensive preparations that began in Washington following the positive identification of Soviet offensive missile capability in Cuba on October 15 were tightly bound by security. So necessary was it to prevent a leak which might possibly compromise the whole U.S. action that even the overseas Unified Commanders were not formally notified until almost the last minute. That this increased their normal problem of coordination with Washington on the one hand and with local Allied nations on the other was fully recognized but was considered unavoidable.

238. It will be recalled that shortly after the President's address to the nation on October 22nd, the State Department dispatched a lengthy cable to all its diplomatic posts, explaining the U.S. course of action <sup>1</sup>

239. The cable is interesting since it encompasses so many of the aspects of inter-Allied coordination that appeared in the crisis. This chapter will examine these in detail and the political-military measures associated with them. The concentration of attention, in terms of Allied concern, was on NATO and Latin America. While it was conceivable that the Communists might respond anywhere around the globe to the U.S. actions over Cuba, the greatest threats lay in those two areas. Accordingly, the military coordination problems of USCINCEUR and USCINCARIB were primary.

---

<sup>1</sup>See Chapter III, "The U.S. Basic Decision."

~~TOP SECRET~~

- 92 -

~~TOP SECRET~~

TOP SECRET

~~TOP SECRET~~

Alerting the Unified Commands

240. It was not until 1214Z on October 20 that the JCS sent a message to all Unified Commanders to the effect that the increased state of tension with respect to Cuba could lead to military action. It promised to keep the Unified Commanders informed, and would direct a higher DEFCON as required. noting



241. This was followed by a formal warning message at 1814Z on October 21, announcing that the President had blockade operations under consideration. It warned that a reaction by the Cuban military forces could lead to U.S. air strikes and an invasion of Cuba. Preparations for both were in progress. These actions, if initiated, it was recognized, would probably result in use of force against Soviet military and civilian personnel in Cuba and would thereby directly challenge the prestige of the Soviet Union. Under these circumstances, the reaction of the Soviets could not be predicted. Therefore, it was imperative under circumstances which could arise to present the strongest possible deterrent to any course of Soviet military action. The U.S. must unequivocally demonstrate it was ready militarily to meet and to defeat retaliatory Soviet moves at whatever level was necessary. At the same time, the message cautioned against actions in other areas which might be considered provocative or which could create civil alarm.

242. The JCS warned the CINCS that, should action include air attack and invasion, the reinforcement capabilities for

---

<sup>1</sup>JCS Message 6807 to all CINCS, 201214Z, October 1962, TOP SECRET

TOP SECRET

- 93 -

~~TOP SECRET~~

the European and Pacific Commands, as reflected in the Joint Strategic Capabilities Plan, applicable for general war, might be delayed. All commanders were ordered to review their applicable plans and were to be prepared to report critical limitations to the conduct of general war operations in their respective areas.<sup>1</sup>

243. Defense Condition Three was established for all U.S. forces at 2300Z October 22, with USCINCEUR being authorized to exercise his discretion in complying with this directive in the light of the requirement for nonprovocation expressed in the JCS warning message. (The JCS requested that as SACEUR, USCINCEUR use his influence with the North Atlantic Council to get NATO to assume a comparable defense posture.<sup>2</sup>)

244. With the imposition of MINIMIZE worldwide at 2300Z on the 22nd, the process of alerting was completed.<sup>3</sup>

245. While formal notification of the CINCS came late in the week of preparation, undoubtedly some indication of a forthcoming crisis had reached all of them. Individual Service messages and information copies were already circulating. CINCPAC received a strong hint in a JCS message on air defense of the Canal Zone on the 19th<sup>4</sup> and in the order to transfer two LSTs to CINCLANT.<sup>5</sup> CINCPAC got a similar indication from the JCS order on the 19th to assemble immediately amphibious shipping in anticipation of possible transferring of operational control of the 5th MEB's sea echelon to CINCLANT.<sup>6</sup>

<sup>1</sup>JCS Message 6830 to all CINCS, 211814Z, October 1962, TOP SECRET

<sup>2</sup>JCS Message 6864 to all CINCS, 221809Z, October 1962, TOP SECRET.

<sup>3</sup>JCS Message 6883 to all CINCS, 222300Z, October 1962, TOP SECRET

<sup>4</sup>JCS Message 6778 to CINCPAC, 191720Z, October 1962, TOP SECRET.

<sup>5</sup>JCS Message 6787 to CINCPAC, 192037Z, October 1962, TOP SECRET.

<sup>6</sup>JCS Message 6796 to CINCPAC, 192231Z, October 1962, TOP SECRET.

~~TOP SECRET~~

TOP SECRET

241. Of the four overseas Unified Commands, MELM was least likely to be immediately involved in a Communist reaction, with PAC coming next. The two most critical were EUR and CARIB. While it was thought to be almost certain that CINCARIB would be immediately called upon for support action to help suppress rebellions against Latin American governments, the possibility of a Soviet riposte in Europe, even if somewhat less immediate, would be infinitely more serious. Yet it would appear that in the nature of surrounding circumstances, USCINCEUR received least advance notice of all the CINCS.

B. COORDINATION WITH NATO

247. The military-political problems of coordination with NATO break down into three convenient aspects. First was the problem of alerting U.S. forces in Europe; then came informing the NATO Allies of the U.S. moves against Cuba; finally there was the matter of NATO political and military reaction.

The Alerting of U.S. Forces<sup>1</sup>

248. As hints of the forthcoming crisis began to reach the European Command toward the end of the week of October 14, the dilemmas to be faced should the Soviets retaliate in Europe became painfully clear and made the lack of more adequate information on developments in Washington appear not only frustrating but highly dangerous. The feeling was articulated in a message to USCINCEUR from the Commander, USAFE, on the 19th. General Landon wrote on the basis of hints and strong inferences from messages and information copies that action might be in the offing in connection with [CINCLANT OPLANS 312 and 314]. He pointed

<sup>1</sup>For a discussion of the formal mechanism involved in alerting the CINCS, see Enclosure B of this study, titled "Procedural Analysis of J-3 Command and Control Operations during the Cuban Crisis, October 1962."

TOP SECRET

- 95 -

~~TOP SECRET~~

out that any contemplated action which exacerbated East-West relations would likely bring increased tensions or action in Berlin, in preparation for which certain precautionary measures should be taken to improve the readiness posture of U.S. forces. The piecemeal information received thus far, he asserted, raised questions as to just what may be expected; for example, if actions elsewhere in support of Caribbean operations should require all available forces, could he expect to receive the TAC additive forces on which USAFE relied heavily to meet Berlin contingencies? He felt it was vital to the U.S. posture to know now if he would be expected to deal with Berlin with forces currently available.<sup>1</sup>

249. There is no record immediately available of the answer from USCINCEUR. The problems of reinforcement for Europe and the reconstitution of a general war reserve were to continue to receive attention, although not part of this report. The important point here was the inhibiting influence which lack of information appears to have had, since it may be assumed Army planners experienced similar reactions to those of USAFE.

250. [

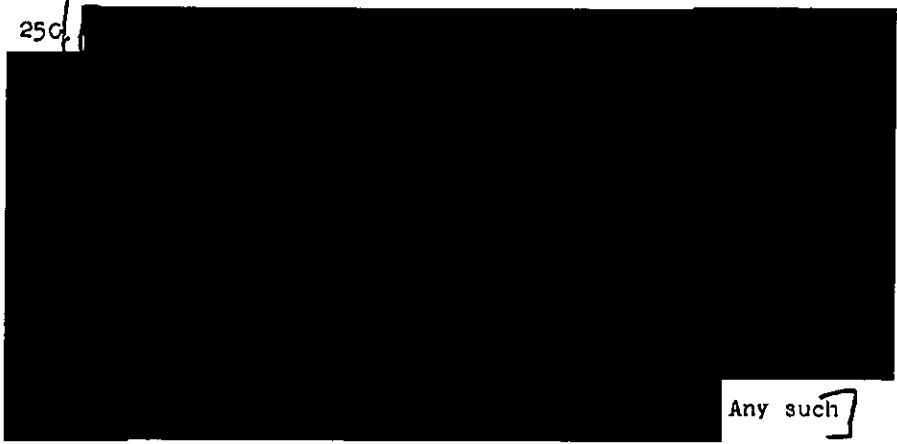

Any such ]

<sup>1</sup>Message from Commander USAFE to USCINCEUR, 191829Z, October 1962, TOP SECRET.

[measures, he insisted, should be taken through NATO, and there was presently no intelligence available to the Allied Command Europe which would indicate that an increased alert posture might be appropriate in the near future because of the Cuban situation.<sup>1</sup>

251. The political sensitivity of USCINCEUR's dual role was threatened at the same time by USCINCEUR component commanders

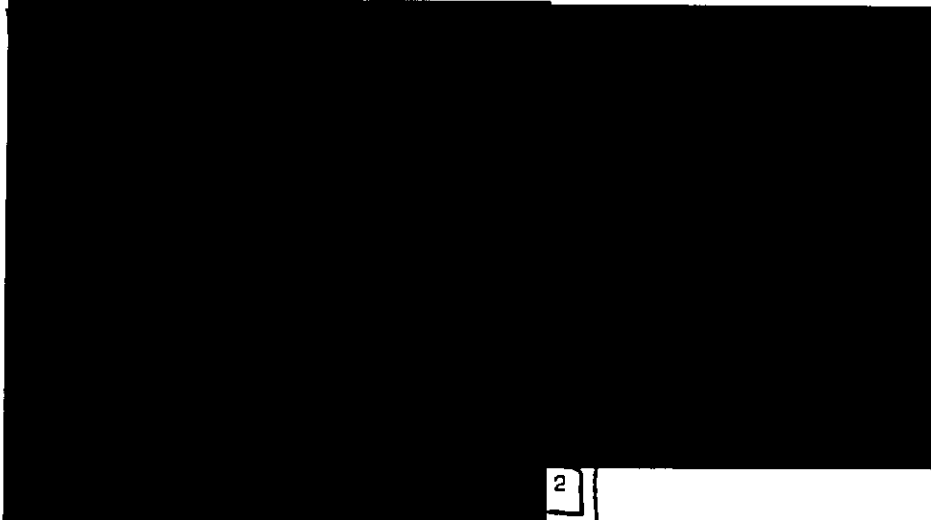

252. Following the formal JCS warning message of 211814Z October, USCINCEUR was notified that Dean Acheson would brief the North Atlantic Council on the Cuban situation two hours before the President's speech, October 22 (then set for 1900, Washington time). This JCS answer to USCINCEUR's message of the previous day also stated that Ambassador Finletter would seek NAC instructions to NATO commanders with regard to an alert posture.

<sup>1</sup>Message from USCINCEUR to JCS, 211436Z, October 1962, TOP SECRET.

<sup>2</sup>Message from USCINCEUR to CJCS, 222255Z, October 1962, TOP SECRET.

~~TOP SECRET~~

TOP SECRET

253. At 0925Z on the 22nd, USCINCEUR replied to the formal JCS warning message of the previous day, stating that his knowledge of the Cuban situation was limited to the two JCS warning messages. Thus, he felt he had no basis for commenting on the substance of the action proposed. He stated that if the situation was serious enough to warrant sending Acheson over to brief the North Atlantic Council and to ask for a NATO alert, he should have been given before this time some information on the "why" as well as the "what" in order to discharge properly his responsibilities which could rapidly become critical.

254. Using the two points raised in the JCS formal warning message, he stated that he could not comment on whether a NATO alert would be "considered provocative" since he did not know the background, but such action would certainly create "civil alarm" of a very high order. He trusted also that the consequences of a rejection by the NATO Council of an American request for NATO forces to assume an alert posture were not being overlooked, since he felt that unless the case for such an action were overwhelming and dramatic, opposition may be expected. Furthermore, it should be assumed that even discussion of the subject would very shortly become public knowledge in Europe.<sup>1</sup>

255. USCINCEUR-SACEUR's dilemma was recognized by a personal letter from President Kennedy, acknowledging concern for the impact of the Cuban situation upon NATO and upon General Norstad's role as SACEUR. The President regretted the inability to widen the circle of discussion during the previous week and especially to enlist the prior support of the NATO Governments, and expressed confidence in the General's ability to help the U.S. over a difficult situation in the NATO relationship.<sup>2</sup>

<sup>1</sup>Message from USCINCEUR to CJCS, 220925Z, October 1962, TOP SECRET.

<sup>2</sup>Message from the President to General Norstad (JCS pass to), 221822Z, October 1962, SECRET.

TOP SECRET

- 53 -

~~TOP SECRET~~



TOP SECRET

~~TOP SECRET~~

256. USCINCEUR responded to the JCS message of 221809Z, which had established DEFCON 3 but had authorized USCINCEUR discretionary power in the decision, by stating that in view of SACZUR's action placing all ACE forces in the same precautionary posture, he had not placed USEUCOM forces in DEFCON 3 status. Instead, these forces were directed to take military precautionary measures in accordance with those recommended to all ACE force commanders and Ministries of Defense. Such measures included the intensification of intelligence collection; increased security and anti-sabotage plans; review of alert procedures and emergency plans; the manning of operational centers at reduced strength; and checks of equipment and supplies.

257. No measures would be taken which could be considered provocative or which might disclose operational plans, and all actions would be taken as far as possible without public notice.<sup>1</sup>

258. Further, to avoid excessive alarm, USCINCEUR imposed MINIMIZE only for messages addressed to areas outside EUCOM.<sup>2</sup>

259. It would appear that USCINCEUR decided to enforce a greater degree of stringency the next day, since he reported that he had imposed MINIMIZE on USEUCOM effective 241631Z October. Furthermore, effective 241630Z he had directed an increased state of readiness for Hq. USEUCOM, and had ordered the airborne command post to be continuously in the air as of 241205Z.<sup>3</sup>

260. No reason has been found for this apparent change. On the whole, USCINCEUR's approach to the Cuban crisis reflected the prevailing European attitude that this was not a European matter

<sup>1</sup>Message from USCINCEUR to JCS, 230039Z, October 1962, TOP SECRET.

<sup>2</sup>Message from USCINCEUR to JCS, 230115Z, October 1962, CONFIDENTIAL.

<sup>3</sup>SITREP, USCINCEUR to AIG 930, 251225Z, October 1962, TOP SECRET.

TOP SECRET

~~TOP SECRET~~

and that any attempt to involve Europe in it would be unnecessarily provocative and could only make a tense situation worse.

261. It might be noted here that there were two other cases in the Cuban crisis involving political complications about the alerting of U.S. forces to DEFCON 3. One of these involved the U.S. forces in Korea. The Commander, U.S. Forces Korea, informed CINCPAC that establishment of the higher DEFCON for his command dictated that the Republic of Korea forces maintain a similar alert status. It was his intention to place ROK forces under DEFCON 3 at the same time as his U.S. forces, but he was advised by CINCPAC not to take action until receipt of specific instructions from the JCS.<sup>1</sup>

262



263. A much more serious case involved Canadian participation in NORAD. While USCONAD went on DEFCON 3 at 2300Z on October 22,

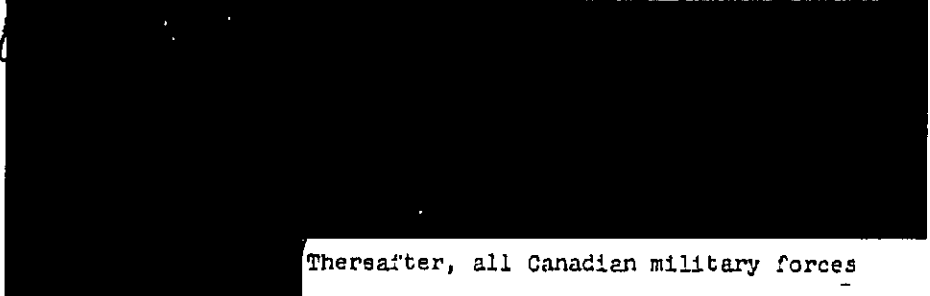

Thereafter, all Canadian military forces

<sup>1</sup>Message from ADMINO CINCPAC to JCS, enclosing message from COMUSK, 230325Z, October, CONFIDENTIAL.

<sup>2</sup>Message from CINCUNC Korea to CG USA, USN, USAF Korea, 231103Z, October 1962, CONFIDENTIAL.

<sup>3</sup>Message from Canadian Joint Staff, Washington, D. C. to JCS, 24 October 1962, SECRET.

<sup>4</sup>Message from CINCNORAD to JCS, 241830Z, October 1962, SECRET.

TOP SECRET

~~TOP SECRET~~

assumed a state of readiness both in Canada and Europe, all readiness measures being closely coordinated to be compatible with the U.S. posture.<sup>1</sup>

264. At the same time the NMCC was authorized to notify the Canadian Joint Chiefs of Staff and the Chairman of the Canadian Joint Staff, Washington, D. C., of any changes in DEFCON for LANT, PAC, CONAD, AL.<sup>2</sup>

Informing the Allied Powers

265. It will be recalled from the chapter on precrisis U.S. policy toward Cuba that until the moment when the Soviet missile bases in Cuba were exposed, our European and Latin American Allies generally took a less than sympathetic view of American policy toward and thinking about Castro's Cuba. In the case of Europe, it was widely felt that Cuba had become an American obsession which blinded us to even the possibility of a long-term rapprochement with Cuba. In Latin America, 'Fidelismo' apparently attracted large segments of the population. Not merely was Cuba supported by Leftist groups, but without doubt lingering animosities toward the United States were sharpened by Castro's successful defiance of American hostility. There had been some change in Latin America during the previous year as Castro openly embraced Communism and the Soviet Union. Nevertheless, it was difficult to gauge the real measure of support Castro could muster in Latin America.

266. Consequently, it was felt by the U.S. decision makers that much depended upon the nature of the presentation of our case to these nations.

<sup>1</sup>J3 Cuba SITREP 10-62, as of 010500Z, November 1962, TOP SECRET.

<sup>2</sup>J3M-1245-62, 24 October 1962, SECRET.

TOP SECRET

- 101 -

~~TOP SECRET~~

267. Information concerning the forthcoming American move was transmitted to the NATO allies in a number of ways. The responsibility was kept by the President himself.

268. On Sunday, October 21, letters from the President were prepared for Prime Minister Macmillan, President de Gaulle, Chancellor Adenauer, Premier Nehru, Premier Disfenbaker, Premier Fanfani, Mayor Brandt of West Berlin, and a number of other leading Allied leaders. These were sent in code to the U.S. Embassies of the respective countries for delivery the next day. Altogether individual letters were sent by the President to forty-three Heads of Government, many of these being outside the NATO area.

269. During the day of the 22nd, Prime Minister Macmillan was personally briefed by U.S. Ambassador Bruce, President de Gaulle by Mr. Acheson, and Chancellor Adenauer by Ambassador Dowling. It was later repeatedly reported on good authority in the press that the President had also personally phoned these three leaders. However, no confirmation of this has been found in the available records.

270. Mr. Livingston Merchant was called in to prepare for a mission to Ottawa to brief the Canadian Government.

271. As previously mentioned, Mr. Acheson flew to Paris to brief the North Atlantic Council two hours before the President's address to the nation. At 1815 EST, the ambassadors of forty odd nations in NATO, CENTO, SEATO and a number of

<sup>1</sup> Chronology of the Cuban Crisis; drawn from DOD, State Department, and White House material. No indication of authorship no date. In J-3 files in Battle Staff material. Appears to be official release.

TOP SECRET

~~TOP SECRET~~

other friendly states were assembled in an auditorium at the State Department for a briefing by the Undersecretary of State. At the end of the briefing the ambassadors watched the President's address on a giant television screen. Following the President's address, a briefing was given to ambassadors of all other countries.<sup>1</sup>

272. Briefings continued through the week, and J-3 was directed to give daily briefings to the NATO Standing Group.<sup>2</sup> The Director of Operations of J-3 had earlier been directed to provide daily briefings for the Chairman of the Canadian Joint Staff in Washington.<sup>3</sup>

273. A comment may be made here regarding U.S. policy in the U.N. during the crisis. The U.S. made full use of the U.N. as a public forum in which to maximize the embarrassment and confusion of the Russians, at the same time indicating the reasonableness of the U.S. actions. In this regard, the U.N. proved extremely useful in the political part of the U.S. offensive. However, the U.S. was obviously under no illusions as to the value of opinion in the "neutral" states. The cynical double standard revealed by the neutralists at the Belgrade Conference in September 1961 had fully shown how unreliable the uncommitted states were even when the U.S. position was unassailably in the right.

#### NATO Political and Military Reactions

274. As a body, NATO lined up solidly behind the U.S. position, but this was not done at a uniform pace by the individual states.

<sup>1</sup>New York Times, October 22, 1962.

<sup>2</sup>J-3 Master Check List for Cuban Operations, October 26, 1962,  
TOP SECRET

<sup>3</sup>J3M-1245-62, 24 October 1962, SECRET.

TOP SECRET

- 103 -

~~TOP SECRET~~

TOP SECRET

~~TOP SECRET~~ E

The fourteen other members of the NATO Permanent Council in Paris took under urgent consideration the question of a military alert, but it would appear from the failure to implement a general alert that their appreciation of the peril in Europe, in terms of a Soviet riposte there, may have differed from the American view. However, the matter of force alerts in Europe was a somewhat different matter from political support of the American position.

275. The general official attitude prevailing may well have been expressed by President de Gaulle for most of the rest of NATO. <sup>1</sup>Information from the British Embassy in Paris reported a discussion between the British Ambassador with the French President in which de Gaulle said he would follow the British lead in sending instructions to the French U.N. delegation to support the U.S. resolution. President de Gaulle was reported to have said that as long as the situation concerned only Cuba, he was willing to follow American initiatives in the matter, but that should the area of action expand, he would insist upon tripartite consultation <sup>2</sup>

B/1/3  
AS

276. On October 23rd, the British government declared its support of the American position. On the same day Chancellor Adenauer wrote President Kennedy, expressing appreciation for the concern over Berlin evinced in the President's speech, and stating that he felt the events in Cuba were the most serious threat that the Russians had ever made against the Free World.<sup>2</sup> Prime Minister Macmillan, addressing Commons on the 24th, again supported the U.S. position in its objectives, but did not specifically endorse the U.S. quarantine. The Canadian,

<sup>1</sup>Department of State Message from American Embassy, Paris, to Secretary of State, 231252Z October 1962, CONFIDENTIAL.

<sup>2</sup>Department of State, Message from American Embassy, Bonn, to Secretary of State, 231601Z October 1962, SECRET.

TOP SECRET

- 104 -

~~TOP SECRET~~

Netherlands, and Italian governments endorsed the U.S. stand that day, but France remained "officially silent," presumably because of the lack of prior consultation.<sup>1</sup> By the 25th, only Portugal of all NATO remained noncommittal.

277. However, despite governmental approval, the U.S. move was generally coolly received at best in the European press. Minor anti-American demonstrations occurred on both sides of the Iron Curtain, specifically on the NATO side, in London. The publication of the official U.S. photographs of the Soviet missile sites on the 24th, however, brought an almost abrupt change in European public opinion, swinging it around to a much more sympathetic position.<sup>2</sup>

278. The military responses were equally erratic. It would appear that while SACEUR had established certain precautionary steps for the NATO forces under his command instead of DEFCON 3, each nation responded in its own way and according to its own appreciation of the situation when it came to national forces not under SHAPE control.

279. It was reported that British forces were alerted, but this has not been confirmed by the author.<sup>3</sup> By midnight of the 24th, five countries had responded to one degree or another. [REDACTED] CIA reported precautionary measures taken to increase alert [REDACTED]

<sup>1</sup>New York Times, October 25, 1962.

<sup>2</sup>J-3 Supplementary Cuba SITREP, 242000Z October 1962, TOP SECRET.

<sup>3</sup>Prime Minister Macmillan revealed in June 1963 that the British Bomber Command, and specifically the V-Bomber force, had been put on alert.

E

280.

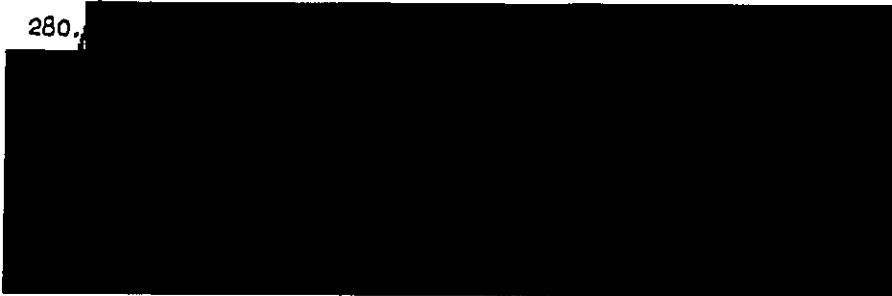

113

281. Apparently, the military chiefs in all these states were from the beginning enthusiastically in support of the U.S. action, but were unable to raise alert levels until directed by the political authorities. Neither these authorities nor, for that matter, SACEUR, felt the need to do so. This may have been largely a matter of outlook, of difference in perspective when viewing the Cuban crisis from Europe instead of the U.S. There was also very likely a marked reluctance to do anything which might aid in provoking or providing an excuse for a Soviet riposte in Europe.

282. In the actual implementation of the quarantine, Allied cooperation was soon achieved. The British on the 24th asked their shipowners to cooperate and to permit U.S. search parties aboard their vessels.<sup>2</sup> There were no problems with NATO on this point. However, some confusion and unspoken disagreement did arise in the never fully developed American effort to establish an air quarantine to match the sea effort. This effort was aimed primarily at African states over whose territory Bloc aircraft would fly, but some aircraft did travel via the United Kingdom and Gander, Newfoundland



113

<sup>1</sup>Message from MAAG Germany, to USCINCEUR, JCS, OSD, 251800Z October 1962, CONFIDENTIAL.

<sup>2</sup>J-3 Cuba SITREP, 242000Z, October 1962, TOP SECRET.



TOP SECRET

Obligations under International Civil Airlines Organization with the desire not to run counter to U.S. objectives.

283.

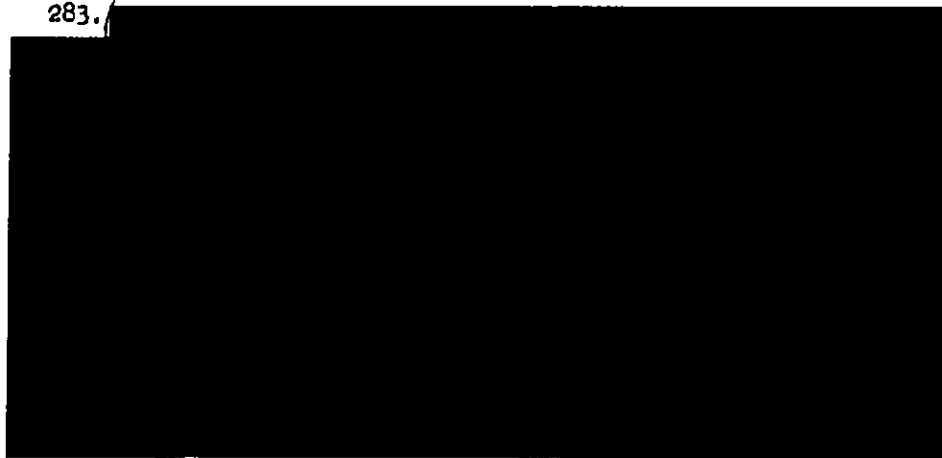

C. COORDINATION WITH LATIN AMERICA

284. While the U.S. desire for Latin American support in the Cuban quarantine was essentially political in nature, there were positive military advantages which might flow from such support. The blockade plan as issued by the JCS on the 22nd of October included a statement which said:

"Prior to or immediately following the Presidential Proclamation, efforts will be made to enlist the aid of Allied or friendly nations in enforcing the blockade. CINCLANT should cooperate fully with such nations and take every advantage of their contributions to increase the efficiency of the blockade and to reduce the commitment of U.S. forces."

285. This point seems to have borne more weight than was generally realized, in view of the concern felt (as illustrated by the European case cited earlier) over the commitment of nearly all available U.S. contingency resources to possible Cuban operations.

<sup>1</sup>Dept. of State, Telegram Ottawa to Secretary of State, 230345Z, October 1962, SECRET.

<sup>2</sup>Dept. of State, Circular Telegram 875, 082237Z, November 1962, CONFIDENTIAL

<sup>3</sup>JCS Message 5848, to CINCLANT, 221111Z, October 1962, TOP SECRET.

TOP SECRET

TOP SECRET

285. The steps followed in preparation for Latin American coordination resembled those taken in Europe.

287. On October 19, all U.S. Ambassadors to Latin America were ordered to return to their posts. On the 20th, the U.S. Information Agency prepared to go on a twenty-four-hour a day schedule of transmission in Spanish. On the same day the Department of State sent 'preposition messages' to all Latin American posts, subject to the 'go' signal on the 22nd, indicating the course of action to be followed. These messages alerted the U.S. posts to the possibility of outbreaks, and procedures were to be initiated for the protection of the Embassy or Consulate, its classified contents, and its personnel. On the 22nd, nine radio stations were requested by the White House to broadcast the President's speech in Spanish to Latin America.<sup>1</sup>

288. The Inter-American Defense Board happened to be meeting in Tegucigalpa, Honduras, at this time and the JCS took advantage of this opportunity to reach the Latin American members. The senior U.S. Army and U.S. Navy representatives were requested to obtain the earliest possible briefing from the U.S. Ambassador in Honduras on current developments and on U.S. plans for implementing multinational action in regard to Cuba. They were informed that the President desired the widest possible OAS participation in the actions against Cuba, including provision of naval forces, and were urged to exert pressure to convince their Latin American colleagues, subsequent to the President's speech.<sup>2</sup>

<sup>1</sup>Chronology of the Cuban Crisis, cited previously, UNCLASSIFIED.

<sup>2</sup>Message from CJCS 5360 to U.S. ARMA, Honduras, 222141Z, October 1962, TOP SECRET.

TOP SECRET

~~TOP SECRET~~ E

TOP SECRET

289. On the 23rd, the Secretary of State addressed the OAS Organ of Consultation in Washington at 0900 EST. At 1500 the OAS reconvened and by 1645 EST, by a 19 to 0 vote, it had adopted the U.S.-sponsored resolution backing the quarantine and urging immediate removal of the Soviet missiles.<sup>1</sup> The sole missing vote was Uruguay, on a procedural matter. She made the vote unanimous shortly afterward.

290. [As in the case of the NATO countries, the Latin American states followed their declaration of support with strictly individual follow-up actions. Each was governed by a wide degree of constraints and motivations, so that collective action really remained only a symbol. [Their responses to the U.S. suggestions of active participation were extremely erratic, and none displayed flesh as well as spirit until the heat in the missile crisis had diminished to a large extent. In fact, as late as November 5th,] the OAS was unanimously approving an Argentine proposal calling for the coordination of hemispheric assistance in the Cuban situation among the Latin American Republics "to establish coordinated and efficient action of their combined forces" in helping maintain the quarantine.<sup>2</sup> ]

LIAS

291. Before examining Latin American reactions to the crisis, it is necessary to consider what plans and preparations the U.S. had in hand for the protection of Latin American governments and for the protection of its own interests in the area in the face of possible Cuban or Communist counterpressures. American policy toward the Latin American states may be viewed as a two-part operation summarized in the two words 'protection' and 'contribution. However, we could not elicit contributions unless we could be sure those governments would be able to maintain themselves. This was the job of CINCARIB.

<sup>1</sup>Chronology of the Cuban Crisis, UNCLASSIFIED.

<sup>2</sup>13 Cuba SITREP 15-62, 030500Z, November 1962, TOP SECRET

TOP SECRET

~~TOP SECRET~~

TOP SECRET

The Threat and CARIBCOM Capabilities

292. It was generally expected that the Communist reaction in Latin America would be strong enough to require the use of U.S. military force in at least one place. On the 19th of October the Deputy Secretary of Defense, Mr. Gilpatric, wrote to the JCS with two requests:

a. That CINCARIB be instructed to prepare lists of control measures, riot control equipment, etc., needed by Latin American states in the event of U.S. action against Cuba. He emphasized that we must be ready to support CINCARIB to assist shaky governments in the face of large demonstrations.

b. That it be determined which Latin American states could assist in a blockade through the OAS or by other means. He wished to know which states had naval resources to assist us, which ones we could count on, and how we could approach them

293. The JCS, in its reply the next day, said that it felt that non-Communist opposition elements would be disturbed, but not to the point of violent disturbance either against the U.S. or their own governments. The Communists could be expected to exploit the U.S. action, and would foment a wave of violence and terrorism both to distract the U.S. and to prevent their own governments from supporting the U.S.

294

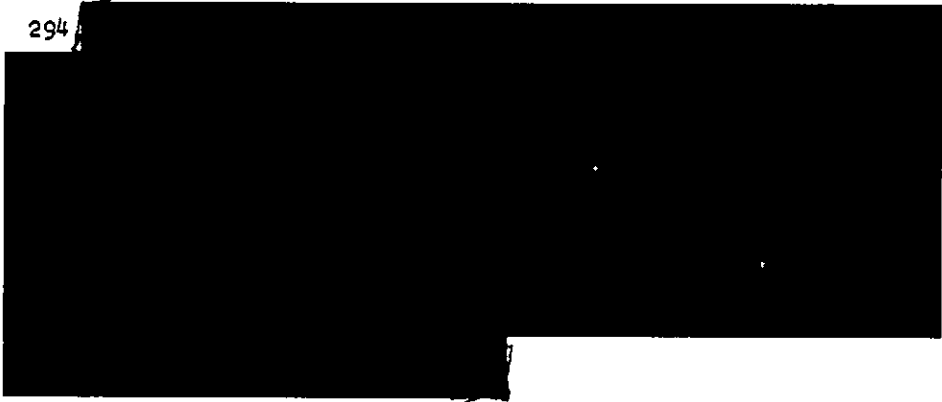

TOP SECRET

TOP SECRET

295. In the matter of specific internal reactions, it was felt that the most serious disorder would occur in Brazil and Bolivia, with lesser trouble in Ecuador and Guatemala and a strong potential for trouble in Venezuela and Colombia.

296. Finally, in the matter of expected assistance, it was felt that only Colombia, Venezuela, and the Dominican Republic were likely to be willing to participate, for a maximum total of eight destroyers and ten frigates.<sup>1</sup>

297. It is interesting to note that in the actual event only the last item mentioned came close to fulfilling prediction.

298. The JCS on the 21st sent CINCARIB a message encompassing much the same sort of questions as had been raised by the Gilpatric letter. CINCARIB was told that in the event of direct action against Cuba, violent Communist reactions might occur and requests for U.S. aid must be anticipated. Answers were urgently requested from him in regard to: (1) the countries where we could expect the most serious reactions; (2) CINCARIB's estimate of the capabilities of these governments to control disturbances, (3) the U.S. support these governments would need in the form of mobile forces, supplies and equipment; (4) CINCARIB's estimated support requirements in terms of personnel, equipment, supplies over and above present resources in the event it should become necessary to execute any CARIBCOM contingency plans; (5) the location and quantity of riot control equipment available in the command.<sup>2</sup>

299.  B112

<sup>1</sup>JCS 2304/74, October 23, 1962, TOP SECRET, RESTRICTED DATA.

<sup>2</sup>JCS Message 6819 to CINCARIB, 210434Z, October 1962, TOP SECRET.

~~TOP SECRET~~

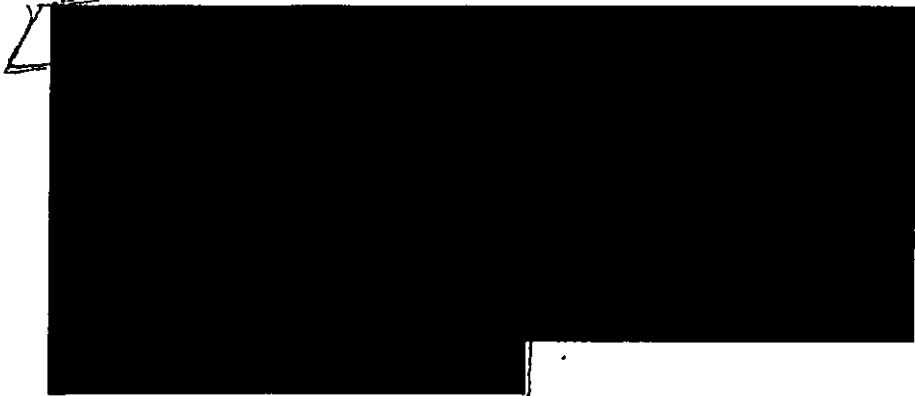

BIAS

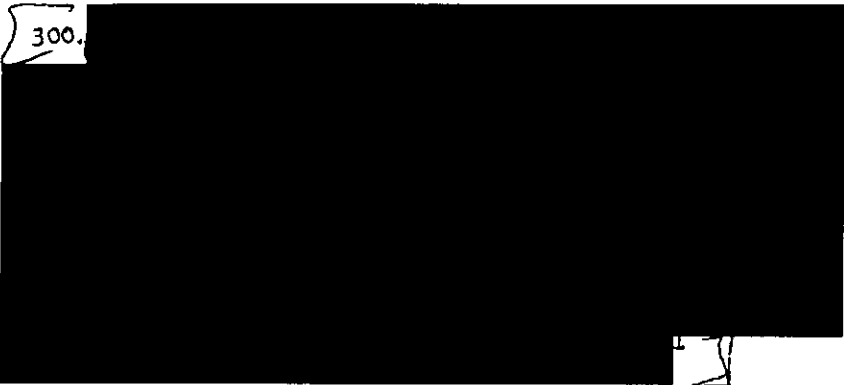

300.

BIAS

301. Three days later the JCS again warned CINCARIB that disturbances might well occur in several countries simultaneously, and requested that he extend his earlier appraisal of his requirements to include the minimum means estimated necessary to meet simultaneously requests for U.S. aid that were likely to come from critical countries.



302.

BIAS

<sup>1</sup>Message CINCARIB to JCS, 211150Z, October 1962, TOP SECRET.  
<sup>2</sup>JCS Message 6961 to CINCARIB, 242304Z, October 1962. TOP SECRET

~~TOP SECRET~~

~~TOP SECRET~~



B1 A1  
A/B

303. As to his own capabilities, CINCARIB replied that he could provide the joint task force headquarters and the airborne companies for the two Task Force Alphas, but he could provide airlift for only one TF Alpha. The joint task force headquarters and airborne battalion of one TF Bravo could also come from CARIBCOM. USSTRICOM would have to provide the rest.<sup>1</sup> CINCARIB had one brigade of two tailored "battle groups" as his Canal Zone combat force, something under 2000 men. With only six C-130 aircraft as airlift, his task in the face of more than one call for help was overwhelming.

304. Apparently the last exchange with CINCARIB raised such concern in the JCS that steps were immediately begun to reinforce him. CINCSTRICOM and CINCARIB were asked for recommendations on the best method of augmenting CARIBCOM.<sup>2</sup> The JCS was thinking in terms of additional U.S. forces whose presence in CARIBCOM would provide both a deterrent and an immediate response capability for action or a show of force in one or more Latin American countries. In view of the residual force capabilities available to STRICOM after OPLAN 312/316 requirements were covered, the two CINCS were requested to design an austere augmentation force requirement.<sup>3</sup>

12/15

<sup>1</sup>Message CINCARIB to JCS, 251900Z, October 1962, TOP SECRET.

<sup>2</sup>JCS Message 7108 to CINCSTRIKE, CINCARIB, 301342Z, October 1962, TOP SECRET.

<sup>3</sup>JCS Message 7175 to CINCSTRIKE, CINCARIB, 020356Z, November 1962, TOP SECRET.

~~TOP SECRET~~

305. In the exchange CINCARIB outlined both his estimate of forces and their missions. Forces deployed to CARLCOM should be prepared for further deployment to any objective listed in the Command's contingency plans.



305. This, then, was the U.S. concept for the most extreme form of coordination with Latin America. Agreement was promptly reached on increasing CINCARIB's capability to carry it out and approved by the JCS on November 11. The augmentation became CINCSTRIKE OPLAN 2-c, but was never carried out.

307. Despite the unexpectedly mild Communist reaction in Latin America, the fear of further trouble was slow in dying. On October 31, the J-3 Cuba SITREP reported that Communist activities in many Latin American states had increased, possibly in response to Cuban directive, and that government plans were underway in all twenty countries to counteract the threat.<sup>2</sup> However, by November 4th, the J-3 SITREP was reporting that the current major fear was of widespread sabotage only, the Soviet retreat apparently having thrown local Communist parties into such confusion that overt action was no longer possible.<sup>3</sup>

<sup>1</sup>Message CINCARIB to CINCSTRIKE, 032110Z, November 1962, TOP SECRET.

<sup>2</sup>J-3 Cuba SITREP 9-62, 310500Z, October 1962, TOP SECRET.

<sup>3</sup>J-3 Cuba Supplementary SITREP 26, 042100Z, November 1962, TOP SECRET.

~~TOP SECRET~~



TOP SECRET

308. Another facet of the overall CARIB capabilities problem concerned the air defense of the Panama Canal. This was a question of U.S. defensive capabilities in contrast to the essentially offensive ones described above.

309. The subject was raised by JCS when it advised CINCARIB that if a blockade of Cuba were ordered without offensive action against the Cuban Air Force, the possibility existed of air attacks against Ramey AFB, Roosevelt Roads NS, and the Panama Canal. His recommendations for augmentation of the air defenses of the Canal were requested.<sup>1</sup>

310. [CINCARIB's succinct reply was that the Canal Zone was "virtually defenseless against air attack now." He listed the current air defenses (two HAWK battalions and two self-propelled 40mm gun batteries), the actions necessary to utilize to the fullest the existing limited potential, and the very sizable augmentation forces needed, predicated his requirements on a nuclear threat ]

311. The last word on the subject came from the JCS on the 25th stating that CINCARIB's air defense requirements were under review, considering the estimated threat to the Canal and the resources available when weighed against worldwide responsibilities.<sup>3</sup> Presumably the threat was estimated as extremely low, since the Cubans seemed unlikely to strike first, and by the time they could respond to OPLAN 312, their capability to hit the Canal would be gone.

<sup>1</sup>JCS Message 577B to CINCARIB, CINCLANT 191720Z, October 1962, TOP SECRET.

<sup>2</sup>Message from CINCARIB to JCS, 220406Z, October 1962, TOP SECRET

<sup>3</sup>JCS Message 5957 to CINCARIB, 250329Z, October 1962, TOP SECRET.

~~TOP SECRET~~

U.S. Arms Aid to Latin America

312. When requests for U.S. aid actually came to pass, it was for arms and not troops, and the requests themselves were nowhere near as great or widespread as had been expected. The JCS warned CINCARIB on the 21st to be prepared to give riot control support to Panama and other Latin American countries within the limits of his capability, and on the 23rd, U.S. Ambassadors in countries considered critical made commitments, personally delivered to the various heads of state, to supply riot munitions from the Canal Zone stocks as needed.<sup>1</sup> CINCARIB reported on the 24th that the first recipients were the Dominican Republic, Bolivia, and Chile, commenting that requests received to date, with the exception of that from the Dominican Republic, appeared excessive. He asked too for immediate replenishment of the CARIBCOM stock of similar items -- gas grenades, shot-guns, ammunition, radio equipment.<sup>2</sup>

313. Thereafter the action along this line was confined to arms deliveries to CINCARIB for transmission to Bolivia, Chile, Venezuela, El Salvador and Colombia during the next week. With the obvious decline in the likelihood of trouble after November 1st or thereabouts, requests for riot control equipment ceased. In total the quantities disbursed had not been particularly great, and had imposed no major strain on CARIBCOM. Furthermore, additional supplies of riot control equipment were flown to CARIBCOM on the 26th to augment the stockpile and further augmentations were prepared during the next few days.<sup>3</sup>

<sup>1</sup>Message CINCARIB to JCS, 230542Z, October 1962, SECRET.

<sup>2</sup>Message CINCAFIS to JCS, 242050Z, October 1962, SECRET.

<sup>3</sup>JCS Message 6995 to C/S USAF, CINCARIB, 260250Z, October 1962, SECRET.

~~TOP SECRET~~

TOP SECRET

~~TOP SECRET~~

The Panama Canal Transit Issue

314. CINCARIB's connection with actual quarantine operations came about through a curious episode involving the legal status of the Panama Canal. The incident illustrated the type of unforeseen international complication which can arise in a contingency operation. The issue apparently had been raised as early as October 19 in Navy circles, the Navy Flag Plot log recording that the question of an arms ship attempting to pass through the Canal had been sent to Op 60 for comment on the legal aspects. No further action is recorded, however.<sup>1</sup>

315. The subject was next raised by CINCLANT on the 22nd, recommending to the JCS that the Blockade of Cuba Plan be amended to charge CINCARIB with the prevention of the passage through the Canal of ships carrying prohibited material destined for Cuba.<sup>2</sup> The JCS so directed CINCARIB on the 23rd.<sup>3</sup> CINCARIB, alert to the international significance of such an action, promptly pointed out in reply the special status of the Canal under the 1903 Convention with Panama and the Hay-Pauncefote Treaty of 1901 with Great Britain, by which the neutrality of the Canal was affirmed and its freedom of passage to all ships of commerce and war of all nations declared. He suggested that if a ship carrying quarantined cargo were willing to unload its cargo at Balboa, it would be permitted to transit the Canal. In any case, CINCARIB felt the measures were sufficiently significant to require a formal statement from the U.S. Government to world shipping circles.<sup>4</sup>

<sup>1</sup>Navy Flag Plot Log, 192145Z, October 1962, TOP SECRET.

<sup>2</sup>Message CINCLANT to JCS, 222234Z, October 1962, TOP SECRET.

<sup>3</sup>JCS Message 6902 to CINCARIB, 231716Z, October 1962, TOP SECRET.

<sup>4</sup>Message CINCARIB to JCS, 232244Z, October 1962, TOP SECRET.

TOP SECRET

- 117 -

~~TOP SECRET~~

TOP SECRET

316. The Governor of the Canal Zone fully supported CINCARIB's position and urged that the Government of Panama be advised before any further steps were taken or announcements made.<sup>1</sup>

317. The effect of these two telegrams was immediate. The issue had obviously been overlooked in the urgency of planning during that week and, in the absence of an immediate alternative, the JCS ordered CINCARIB to hold all action on the matter of Canal transit until further advised.<sup>2</sup> It would appear that CINCLANT's original suggestion had not been cleared with the Department of State, despite its obviously political content. The JCS had missed its significance, and it had not been caught by the POLAD at CINCLANT, although this is precisely the reason why POLADs are assigned to Unified Command headquarters

318. The Department of the Army notified the Governor of the Canal Zone that CINCARIB would be instructed only to notify masters of designated Cuba-bound vessels that their ships would be subject to quarantine action after passage of the Canal. It was specifically desired not to use U.S. control of the Canal for quarantine purposes. The creation of an international precedent could be a future source of difficulty elsewhere in the world, and the uneasy relationship with Panama further exacerbated.

319. However, these considerations were not to prevent a thorough inspection of any vessel if there were reason to suspect its passage threatened the security of the Canal. Established procedures for the inspection of Sino-Soviet Bloc vessels (set by the Department of State-Department of

<sup>1</sup>Message Governor of Canal Zone to Secretary of the Army, 232242Z, October 1962, TOP SECRET.

<sup>2</sup>JCS Message 6927 to CINCARIB, 240442Z, October 1962, SECRET.

TOP SECRET

Defense agreement of May 1957) were to be continued. If more stringent security measures were desired, the agreement provided for delay of a Bloc vessel pending Secretary of the Army-DoD-Department of State action on the recommendations of the Governor and CINCARIB.

320. [No public announcement was to be made, in order not to draw unnecessary attention to the issue. The government of Panama could be informed by the Governor that more extensive inspection would be made of transiting ships on an individual basis, but that passage would not be denied any ship conforming to security regulations.]

321. These instructions were formalized by JCS two days later. [Transit of a ship was not to be delayed merely because of the presence of prohibited material unless such material immediately threatened the security of the Canal. Results of inspections were to be forwarded to CINCLANT and, in the case of vessels carrying prohibited materials, CINCARIB was to subject the ship to air surveillance upon departing the Canal Zone until it passed beyond the range of surveillance or until CINCLANT accepted responsibility.] The operational aspects of this whole episode are treated in more detail in the chapter on the Naval Quarantine.

Latin American Military Support

322. While U.S. quarantine operations were based upon the expectation that U.S. forces only would do the job, as they also would in the further event of [DPLANS 312-316] being implemented, it was nevertheless considered very desirable to gain some active Latin American support. Mere declarations of support were as evanescent as any words, but active

<sup>1</sup>Message from OUSA Department of Army, to Governor of the Canal Zone, 251422Z, October 1962, SECRET.

<sup>2</sup>JCS Message 7002 to CINCARIB, CINCLANT, 261217Z, October 1962, SECRET.

TOP SECRET

TOP SECRET

cooperation was likely to leave a much more lasting impression. The U.S. therefore went to considerable effort to gain active Latin American support on two fronts, the use of facilities and the actual contribution of forces to the quarantine operations.

All offers were accepted, not only to avoid giving offense through refusal, but to establish the pattern of inter-American military cooperation.

The Use of Facilities

323. There was no shortage of offers of help, primarily in the form of port and airfield facilities for use of quarantine forces. By the end of the 25th, eight Latin American states had offered help.<sup>1</sup> In fact, a problem soon arose in the handling and exploiting of these offers. It became apparent that the offers alone were not sufficient to permit U.S. utilization, but that each required negotiation of some sort. The State Department abdicated any role in this negotiation to CINCLANT and CINCARIB. On October 29, the State Department took note of the definite requirements stated by CINCLANT in connection with the quarantine for the use of aircraft staging, diversion, search and rescue fields, and ports for ship emergencies in Caribbean countries, especially Haiti, the Dominican Republic, Jamaica, and Honduras. State informed CINCARIB and CINCLANT that it had already told DoD that offers of assistance received from the four governments in question were of such a character that specific detailed kinds of requirements could be taken up through military channels, Ambassadors being kept informed. This same guidance was to be valid if similar rights were sought elsewhere in the Caribbean -- Guatemala, El Salvador, Panama.<sup>2</sup>

B1 A5

<sup>1</sup>J-3 Cuba SITREP 4-62, 260400Z, October 1962, TOP SECRET

<sup>2</sup>Message from Secretary of State to CINCARIB, CINCLANT, 292125Z, October 1962, SECRET.

TOP SECRET

~~SECRET~~

324. CINCLANT was authorized on October 30, 1962, to open military level consultations with Haiti, the Dominican Republic, Honduras and Jamaica,<sup>1</sup> and on the following day with Guatemala and El Salvador.<sup>2</sup> While the President of Costa Rica had offered the use of facilities, such an action required the formal approval of her legislature, and it was decided to avoid creating possible political and legal complications for the Costa Rican Government by not requesting any specific rights at that time.<sup>3</sup>

E  
B1 A5

325. CINCARIB had responded to the Department of State message of the 29th by requesting CINCLANT to advise him of requirements for facilities rights, for which he, CINCARIB, would act as military contact in the area.<sup>4</sup> It was not until November 6 that CINCLANT requested him to open military level consultations with Guatemala and Nicaragua in regard to free entry and use of Puerto Barrios, Guatemala, and Puerto Cabazas, Nicaragua. Even though there was no immediate need for the ports, rights for their use were desired.<sup>5</sup>

326. In some cases CINCLANT dealt with the senior U.S. military officer at the Embassy in the particular country, as in the Dominican Republic and Haiti. While in others, El Salvador, Guatemala, and Nicaragua, CINCARIB acted as CINCLANT's representative in dealing directly with the local military.

327. Some of the offers of port and airfield facility use were not restricted to quarantine use. This was the case with Costa Rica, Dominican Republic, El Salvador, Guatemala,

<sup>1</sup> JCS Message 7103 to CINCLANT, 300414Z, October 1962, SECRET

<sup>2</sup> JCS Message 7144 to CINCLANT, 312216Z, October 1962, SECRET.

<sup>3</sup> JCS Message 7119 to CINCLANT, 302154Z, October 1962, SECRET.

<sup>4</sup> Message CINCARIB to CINCLANT, 302250Z, October 1962, SECRET.

<sup>5</sup> Message CINCLANT to CINCARIB, 062000Z, November 1962, CONFIDENTIAL.

~~SECRET~~

~~SECRET~~

and Haiti. This was considered especially useful, and efforts were made to give at least token use to these facilities during the period of operations. As late as November 17, U.S. naval forces were being urged to take advantage of the Haitian and Dominican blanket offer as soon as possible, in order to establish a pattern of use in emergency and thus avoid negotiations and minimize need for discussion. <sup>1</sup>

Latin American Naval Contributions

329. Four Latin American countries officially offered forces for the quarantine and three of them actually deployed units. These were Argentina, Venezuela, the Dominican Republic, and Guatemala, a quartet which came as some surprise in view of earlier U.S. predictions on contributions. In the case of a number of other countries -- Ecuador, Uruguay, Peru, Colombia, and Chile -- the respective naval commanders offered U.S. Embassy personnel the services of their navies, subject, of course, to governmental approval. For their own reasons, these latter governments dragged their feet and avoided a commitment until the crisis had passed.

330. The U.S., for its part, had early begun to plan for the employment of such Latin American naval forces as were offered. On October 25, CINCLANTFLT authorized COMSOLANT to establish a combined Latin American-U.S. force to serve under the Commander Quarantine Force. <sup>2</sup> On the 30th, CINCLANT, by planning directive, formally established the force, to be known as Combined Task Force 137, and to be headquartered at the Naval Station, Chaguaramas,

Message CINCLANTFLT to COMNAVRE SCAFRO, 170102Z, November 1962, CONFIDENTIAL.

Message CINCLANTFLT to COMSOLANT, 252134Z, October 1962, SECRET.

~~SECRET~~



TOP SECRET

Trinidad.<sup>1</sup> At the same time CINCLANT announced his intention to assume direct command of the Latin American forces made available, and he directed CINCLANTFLT to chop COMSOLANT to CINCLANT's operational control. COMSOLANT would be the direct commander of the combined task force under CINCLANT.<sup>2</sup> This was obviously a recognition of the political value of these Latin forces, and by maintaining operational control at the Unified Command level, CINCLANT was indicating his intention to avoid any untoward incidents at lower command levels which might in any way damage that political value.

LIAS

330. Combined Task Force 137 was officially activated for operations on November 13.<sup>3</sup> The quarantine was ended on November 20 and the Latin American ships returned to their national operational control the first week in December.

331. The operational and command and control aspects of the use of Latin American forces are more fully spelled out in the chapter on the Naval quarantine.

332. Both the acceptance of each offer and the utilization of the units involved had special sets of problems, political and logistic. In the case of the Argentine offer, the two destroyers were offered unofficially the day after the President's address, and on the following day the Argentine government officially offered two destroyers, one submarine, and a marine battalion with lift. The view of the senior Argentine officers accorded perfectly with American views, since they viewed their national

<sup>1</sup>Message CINCLANT to CINCLANTFLT, 302312Z, October 1962, CONFIDENTIAL.

<sup>2</sup>Message CINCLANT to CINCLANTFLT, 302324Z, October 1962, SECRET

<sup>3</sup>J-3 Supplementary SITREP 23-52, 140500Z, November 1962, TOP SECRET.

TOP SECRET

TOP SECRET

contribution as small in size but important in its symbolic value.<sup>1</sup> The destroyers would be ready for sea in three days and the submarine sooner. However, at U.S. suggestion, the submarine and marine battalion were put on a standby basis only.

333. On November 3 COMSOLANT was informed that the two destroyers were proceeding for quarantine duty under his operational control, but were limited to operations between 10° and 20° north latitude.

[REDACTED]

2

334.

[REDACTED]

3

335. The problem was recognized by COMSOLANT on the same day when he reported to CINCLANTFLT that he could accommodate the two Argentine aircraft at the CTF 137 headquarters base at Chaguareras but that he feared basing the Argentine Navy and Air Force at the same facility might present complications.<sup>4</sup>

<sup>1</sup>Message ALUSNA Buenos Aires to CNO, 241415Z, October 1962 SECRET

<sup>2</sup>Message CNO to COMSOLANT, 031855Z, November 1962, SECRET.

<sup>3</sup>Message American Embassy, Buenos Aires, to OSD, 022325Z, November, SECRET.

<sup>4</sup>Message COMSOLANT to CINCLANTFLT, 020520Z, October 1962, SECRET

TOP SECRET

~~SECRET~~

335. The matter was apparently solved by basing the Argentine aircraft at MacDill AFB instead, where both were in place with crews by November 6, operating under CINCAFLANT.<sup>1</sup>

337. The Venezuelan Navy on October 25 offered four destroyers, available on four-hour basis, and a submarine, with other destroyers available but of dubious value.<sup>2</sup> The U.S. accepted two destroyers and recommended that the submarine be employed in giving COMSOLANT forces ASW training rather than in quarantine operations.<sup>3</sup> The ships were to be ready for sea on November 2, but had already reported to COMSOLANT on October 30 for planning purposes. /

333. Presumably for reasons of internal security, no public announcement was made in Venezuela, and somehow it was decided a joint Colombian-Venezuelan announcement would be made of their joint participation.



<sup>1</sup>Phone call to Navy Flag Plot, 050.30Z, November 1962  
in cere. in Log.

<sup>2</sup>Message from ALUSNA, Caracas, to DNI, 251813Z, October 1962,  
SECRET.

<sup>3</sup>Message from CNO to ALUSNA, 281307Z, October 1962, CONFIDENTIAL.

<sup>4</sup>Message from ALUSNA, Bogota to CNO, 022140Z, November 1962,  
SECRET

<sup>5</sup>Message from CNO to ALUSNA, Bogota, 031013Z, November 1962,  
SECRET.

~~SECRET~~

~~SECRET~~

339. The Venezuelan destroyers arrived at Trinidad on the 9th and 10th of November and commenced their patrol duties on the 12th. Venezuelan Air Force aircraft were directed to fly logistics for the naval units and to conduct reconnaissance under the Venezuelan CNO. } U1

340. The Dominican Republic offered two patrol frigates on October 25, for use on a rotational basis. This represented an ambitious program and the U.S. Military Group in Santo Domingo recognized the problems inherent in it. The ships both had defective evaporators which needed replacement before the ships could become part of regular U.S. patrol-type operations. It also was unlikely that patrol could be maintained more than two weeks because of ship condition and lack of fuel. In order to secure Dominican friendship and to raise the prestige of the Dominican Navy, these U.S. representatives even suggested the U.S. lend the Dominican Republic three one-hundred-foot Coast Guard type vessels for purposes of quarantine participation. <sup>1</sup> However, instead, the U.S. offered to supply parts and fuel.

341. The two destroyers reported to CONSOLANT on November 4, and CONSOLANT was instructed not to utilize them on stations farther than Mona Passage (the body of water between the Dominican Republic and Puerto Rico) nor to keep them out longer than eight days per ship. <sup>2</sup> The Dominican ships put into San Juan, Puerto Rico, for repair of their evaporators and were ready for sea by November 14.

<sup>1</sup>Message from COMUSMILGP, Santo Domingo, to COMUSMACV, 252117Z, October 1962, CONFIDENTIAL.

<sup>2</sup>Message from CINCLANT to CONSOLANT, 031330Z, November 1962, SECRET.

~~SECRET~~

~~TOP SECRET~~

~~TOP SECRET~~

E

342. The only other Latin American naval unit offered was a frigate which Guatemala offered on November 18, to be ready for sea December 7. The quarantine ended before the politically desirable acceptance could be arranged.<sup>1/</sup>

DIAS

343. The greatest of the Caribbean states, Mexico, declined to send forces to the quarantine operation, but reaffirmed complete cooperation with U.S. efforts, closing her ports to Cuban traffic and setting a ten-ship surveillance patrol in the Yucatan Channel.

344. One final aspect of U.S.-Latin American military cooperation remains to be mentioned. Apparently the measure of success that the U.S. actually achieved in getting Latin American cooperation led to even more expansive hopes. Early in the crisis the concept developed of using Latin American forces in OPLAN 316. This represented such an unlikely possibility that it would be useful to know how it got started.

345. The earliest reference found by the author was in a message from U.S. COMARC/CINCPACFLT to the CG Antilles Command (ANTCOM) on November 7, stating that planning for the possible use of Latin American forces in OPLAN 316 had been initiated. Three basic assumptions were to govern planning. These were that Latin American army forces would not be committed in the initial phase of 316 but in subsequent phases, that the staging of these forces would be through ANTCOM; that these forces would need assistance in

Message from CINCPACFLT to COMSOLANT, 182338Z, November 1962

CONFIDENTIAL

~~TOP SECRET~~

~~TOP SECRET~~

~~TOP SECRET~~

[the matter of equipment prior to commitment of U.S. troops.<sup>1</sup> ANTCOM, it might be noted, was transferred from CINCARIB to the operational control of CINCLANT during the crisis shortly after the dispatch of this message.]

345. The next indication came ten days later with CINCLANT's proposed OPLAN 322-62, directing organization of a task force incorporating Latin American participation.

347. CINCLANT stressed the immense political and psychological value of such forces, no matter in what size units they were involved. His OPLAN provided guidance for the organization and employment of the task force.<sup>2</sup> However, nothing further developed before the ending of the quarantine.]

#### D. SUMMARY OBSERVATIONS

343. There have been two focal points in this chapter. These concern the ways in which the U.S. coordinated its policy decisions with its Allies on the one hand, and with its pertinent overseas unified commanders on the other. The objective of the first effort was to gain the political and military support of our Allies, that of the second, to reconcile the demands of a local contingency situation with global strategic requirements, specifically with requirements in areas potentially threatened as a result of that contingency.

349. The first objective involved primarily the informing of our Allies as to our intentions and goals, in order to assure their cooperation in quarantine operations and their political support in the U.N. arena. The other aspect of this objective

<sup>1</sup>Message from USCOMARC, CINCLANT to CG ANTCOM-CINCARIB, 070040Z, November 1962, TOP SECRET

<sup>2</sup>Message from CINCLANT to JCS, CINCARLANT, CINCARLANT CINCLANTFLT, 172052Z, November 1962, SECRET.

~~TOP SECRET~~

~~TOP SECRET~~

involved our persuasion of the Allies to join with us in maximizing the deterrent posture we presented to the Soviet Union, thus reducing the likelihood of a potentially dangerous Soviet riposte. The expression "Soviet Union" should really be broadened to that of "Communists" generally, since our hope, if not expectation, in Latin America was that by an apparent readiness to assist Latin American Governments in suppressing uprisings, the instigators of such uprisings might be deterred from starting them. By presenting a common posture of readiness, it was felt that there would be a much greater chance of keeping the Cuban situation local. It remains true, nevertheless, that the inability of the Soviets to make a direct riposte in Latin America meant that Europe remained the key area in the deterrent role.

350. In regard to Latin America, however, we pursued as a positive subobjective actual contributions to the operations against Cuba, both for the purpose of establishing a pattern of inter-American military cooperation in time of crisis and as a means of reducing the drain on the U.S. forces.

351. Our pursuit of the first above-mentioned objective was largely a matter of contending with and attempting to manipulate Allied reactions. There was no one set of these. There were distinct, European and Latin American reactions, previous attitudes, initial reactions and subsequent reactions. Previous attitudes toward U.S. Cuban policy ran from quite cool in most of Europe to enthusiastic in parts of Latin America. Initial reactions to the U.S. move likewise ran from horror in parts of Europe to rejoicing in some Latin

DIAS

~~TOP SECRET~~

~~TOP SECRET~~

American states. Subsequent reactions, after release of photographic evidence of the missiles and especially after the Soviet Union agreed to withdraw them, were a combination of respect for the U.S. and a marked relaxation of tension, even though the crisis was far from over on October 23.

352. U.S. policy during the week of October 15-22 was made with an eye to manipulating these already existing attitudes. The nature of the policy which emerged was restrained and offered the Soviets and Cubans a way out. In view of the evidence the U.S. presented, it became difficult to take exception to the U.S. policy. Furthermore, while public opinion varied in regard to the U.S. move, Allied Governments all declared their official support. Had the U.S. opened with an attack on Cuba, it seems clear that Allied Governments would have been subject to tremendous pressure to disown the U.S. move.

DIA'S

353. In view of the character of the American move, the restrained use of force coupled with maximum political pressure, Allied political support was an essential ingredient for the success of that policy. That support was achieved. Yet one may wonder whether it was achieved because the Allied Governments fully believed in the U.S. position or because they feared the consequences of appearing disunited at a possibly critical moment.

DIA'S

354. Regarding the second part of the U.S. objective, persuasion of the Allies, primarily NATO, to adopt certain measures to maximize the overall deterrent posture, the U.S. had little success. It would appear that this was basically a matter of differing threat perception. Since USCINCEUR

~~TOP SECRET~~



himself apparently did not consider a Soviet riposte in Europe as likely, it was hardly to be expected that the NATO countries would. There was also very likely an attitude of resistance to being pushed into military alerts as a result of a unilateral act on the part of the U.S. The value of clear political support for the U.S. was one thing; military response by the Allies quite another. The Europeans seem to have recognized that maintenance of political unity with the U.S. would help dampen down the crisis and thus alleviate the need for any military moves by NATO.]

1.115

355. In summary, the U.S. achieved the political support it wished from Europe, but there was really no united action.]

356. In Latin America, we achieved political support and a good deal of military support. However, again there was really no united action. States moved and responded individually. The military support was actually of far greater political value than military, coming, as most of it did, when the need had already passed.]

357. As to the second focal point of this chapter, the coordination with U.S. overseas Unified Commands, this was primarily a military problem, handled by the JCS, just as the first problem was primarily a political one, handled by the White House and the Department of State. Each problem, of course, contained strong elements of the other. CINCEUR and CINCARIB both played a role in dealing with Allied states in pursuit of U.S. objectives.

358. The problem of timing was the first to arise in this regard, in connection with the alerting of the Unified Commanders. The need for secrecy was the basis of the problem here. Inadequacy of information on the developing situation

~~TOP SECRET~~

~~TOP SECRET~~

left the CINCS little time to coordinate their own plans in the event of a prompt Communist reboste against their plans or to consider alternatives compelled by last minute revisions in their own contingency plans.

359. It was curious that this should occur, since one of the unique characteristics of the Cuban crisis was the fact that the U.S. held the initiative, unlike other crises in which the U.S. has found it necessary to respond to a situation in which the other side provoked and in which the initiative lay with our potential enemy. There was a week in which to coordinate an overall military-political effort instead of hours, as in most other crises. Nevertheless, in the end there was not much more opportunity to coordinate the national effort than in previous cases. The main reason, of course, was the absolutely critical need of preventing a leak which might have allowed the Soviets to demolish the entire U.S. project before it was even launched.<sup>1</sup>

350. Closely related to the problem of timing in the starting of the two most concerned CINCS was the dilemma posed by the USECOM-NATO relationship. This question of how one member of an Alliance with forces committed to NATO can coordinate those forces with the rest of his national forces in meeting a local contingency situation outside the Alliance theater was not resolved in the Cuban crisis. USCINCEUR was granted discretionary power and produced an ad hoc solution.

---

<sup>1</sup>This sensitivity lasted until the very final hours before the President's address. A message went from the JCS to all CINCS (JCS 6859) at 221655Z, October, to the effect that information had just been received that Khrushchev may be about to make an important statement possibly bearing on the Cuban situation, and that the President was considering release of a brief statement on the subject prior to his speech at 222500Z (msg. CONFIDENTIAL). There was considerable relaxation when it was learned that Khrushchev would merely speak at Gromyko's arrival at Moscow airport.

~~TOP SECRET~~

- 132 -

~~TOP SECRET~~

TOP SECRET

TOP SECRET

361. The second major problem involved in coordinating U.S. overseas Unified Commands had its roots in the inadequacy of resources. Both in Europe and the Caribbean additive forces were felt to be needed in order to meet potential developments. Yet OPLANS 312-316 would have absorbed nearly all available regular or quickly mobilizable reserve forces. In both cases lack of the augmentation forces would have seriously hampered contingency plans predicated upon the presumption of their presence. CINCARIB was repeatedly warned to be prepared for single or multiple calls for help, yet steps to augment his force did not even reach the planning stage until the crisis was under way. We were committed to the defense of friendly governments whose support in our policy was sought, yet the means available to do so were extremely thin.

362. In total, the crisis sharply demonstrated the critical interrelationship of military and political factors in national command and control. Political considerations arising from the attitudes of Allies placed restraints upon the military freedom of action of the U.S. We could to some degree influence these attitudes and estimates of the situation, but we could not totally transform them. Such variance is a constant in any alliance of powers with worldwide interests.

363. On the other hand, U.S. national security interests were considered so vitally involved that the U.S. was willing to prepare and launch its move without informing its Allies until the very last minute. No approval was sought. Thus the U.S. showed the limits to political considerations which military necessity can impose.

364. Cuba also illustrated the pressures on command and control created by a contingency situation with possible ramifications

TOP SECRET

- 133 -

TOP SECRET

~~TOP SECRET~~

~~TOP SECRET~~

elsewhere in the world. In short, the U.S. was faced with three possible contingency situations -- Cuba, Europe, Latin America. The last posed the possibility of further multiplication of individual situations. It is highly instructive to contemplate how the U.S. might have responded to trouble in these areas had the attack on Cuba actually been launched.

~~TOP SECRET~~

- 134 -

~~TOP SECRET~~

~~TOP SECRET~~

~~TOP SECRET~~

V. IMPLEMENTING THE MILITARY COURSE OF ACTION:  
THE FIRST PHASE

A. GENERAL PATTERN OF THE MILITARY MOVES

355. The period of national decision making, which ran from October 15 to the 20th, was not accompanied by major military deployments. In fact, the formal JCS warning to the CINCS was not sent until 1814Z on October 21. However, as the decision-making week drew to its close, certain steps were put into effect. The phasing of these was based upon urgency and the degree of danger of specific Cuban counteraction. With the President's address to the nation on the 22nd, all military activity became overt and went into high gear.

356. By the time Premier Khrushchev agreed to dismantle the missile bases, early Sunday morning, October 28th, nearly all the required U.S. moves had been accomplished to fulfill the several missions. The Soviet concession brought a sharp reduction in tension, but U.S. military preparations continued until the very end of the crisis. Nevertheless, the 28th represents a definite watershed, and has therefore been chosen as the terminal point of the "first phase" of the crisis. Continuing deployments thereafter are covered in a later section of this study.

357. Intelligence and reconnaissance activities are not described. They were constant during this week, but because the necessary data were not made available, their existence will only be recognized. The chapter concentrates only on the

~~TOP SECRET~~

- 135 -

~~TOP SECRET~~

~~TOP SECRET~~

TOP SECRET

deployments undertaken to support the President's program of action. However, the chief naval activity, the quarantine, is the subject of a separate chapter.

369. Emphasis herein is on the nature of the higher level problems encountered during the deployments, rather than on any great wealth of detail, and on how these concerns or were dealt with by the JCS. A great many other problems on lower levels of command, highly interesting and instructive in terms of command and control, must necessarily be ignored.

#### B. READYING AND DEPLOYMENT OF CONTINGENCY FORCES

369. The military contingencies faced in Cuban operations were limited blockade, selective air strikes, land, sea, and air defense of Guantanamo and of the southeastern portion of the United States, invasion of Cuba, and preparation for general war. With the exception of the requirements for invasion, these contingencies had all been provided for by the time the Soviet concession came about.

370. The military concept designed to achieve the U.S. objective of removal of the Soviet missiles and prevention of further introduction of such weapons was based upon the establishment of a quarantine, employing U.S. naval forces primarily. The concept for an air quarantine was also under development but was never fully implemented. It was also hoped at the outset that OAS forces would be able to make useful contributions, but these did not materialize until the crisis was almost over. Concurrently, with the blockade, U.S. military forces worldwide progressively would be

TOP SECRET

- 136 -

~~TOP SECRET~~

~~TOP SECRET~~

brought to increased readiness conditions from which prompt and appropriate action could be taken to respond to any aggressive move on the part of Cuba or any member of the Soviet Bloc.

371. Much was accomplished prior to the President's address, but the only actual overt deployment undertaken before the 22nd was to improve the defense of the southeast U.S. Overt action for all other contingencies did not begin until "P" Day. This fact reflected not only the requirement for maximum security to prevent a leak which could have destroyed the effectiveness of the U.S. surprise move, but also the priorities for action which the JCS felt were dictated by the threat.

372. The most likely and simplest Cuban form of response to the U.S. quarantine would be some action against the naval base at Guantanamo. The degree of the Cuban reaction could not be estimated, so it was deemed wisest to prepare for the maximum danger. Should an actual clash between U.S. and Cuban forces occur, either near the naval base or in the air, it was possible that the Cubans might be goaded into attempted raids against the southeast U.S. with their MIG force and such of their IL-28's as were operational. To have attempted this early, before there had been any major military clash, would seem to have been suicidal for the Cubans. On the other hand, it was recognized that their capability to do so was greatest at the outset of the crisis. If they were to wait, they would be caught in the OPLAN 312 strikes which would have very shortly reduced Cuban air capability to zero. Therefore, wisdom also dictated the early strengthening of the air defenses of the southeastern U.S.

~~TOP SECRET~~

TOP SECRET

~~TOP SECRET~~

373. Thus the first two U.S. deployments were defensive in nature. Simultaneously with the second of these came the infiltration into Florida bases of a large number of TAC airplanes in readiness for execution of OPLAN 312. Accompanying this deployment was the move of naval carrier task forces to positions off Cuba from which they could support the defense of Guantanamo and participate in OPLANS 312-316.

374. Preparations for the invasion of Cuba under OPLANS 314-316 moved comparatively slowly, so that little progress had been made toward that end by the close of the first phase. It must be recognized, however, that many of the required deployments here were not to be made until a definite "D" Day had been set. Marine forces assigned were mostly deployed or in the process of moving to assigned assembly areas by the 28th, while Army forces never did reach such a state of preparation.

375. Preparations for general war, both offensive and defensive, moved with speed and effectiveness on the part of SAC, CONAD, and naval strategic forces. All strategic forces were at maximum readiness before the first phase closed.

376. A variety of problems arose during this period, some fairly routine, others unique. As might be expected, most of the problems occurred early in the crisis. The hectic tempo fell off fairly soon, and by the morning of the 25th the Battle Staff could report to the CJCS that the previous twenty-four hours, and especially the last twelve, had been significant because of the "slowdown" of Battle Staff activity. In all areas things were reported as having

TOP SECRET

- 138 -

~~TOP SECRET~~



TOP SECRET

fallen into place and were becoming routine. Movements were generally on schedule as plans were rapidly changed into realities. Both the Army and the Marines had given a negative report in response to the last Battle Staff queries on significant problems or developments.<sup>1</sup>

377. This report will examine the deployments in support of each contingency category.

The Defense of Guantanamo Naval Base

378. The Base Defense Force at Guantanamo, when the crisis began, was obviously inadequate to defend a large area against overwhelming odds for any length of time, especially since the base was surrounded by prepared Cuban positions. The airfield particularly was vulnerable to fire from dominating terrain features. Furthermore, water supply sources were in Cuban hands outside the Base perimeter.

379. [E] OPLANS 314-316 viewed Guantanamo as a useful springboard for operations by reinforced U.S. forces against Cuban forces in the eastern half of the island. [I] Despite its vulnerability, the maintenance of the base was obviously of prime importance. The first step was taken by the JCS on the 18th when it ordered CINCPAC to chop in place one reinforced infantry battalion from the 5th Marine Expeditionary Brigade (5th MEB) of the 1st Marine Division (stationed at Camp Pendleton near San Diego, California) to CINCLANT. CINCLANT would direct the movement to destination and phasing of the movements as necessary.<sup>2</sup>

<sup>1</sup> Briefing for the CJCS, 0800 EDT, 25 October 1962, TOP SECRET.

<sup>2</sup> Message JCS 6764 to CINCPAC, 102343Z, October 1962, TOP SECRET.

TOP SECRET

TOP SECRET

~~TOP SECRET~~

380. On the 19th CINCLANT requested the Commandant, Marine Corps, to move the reinforced infantry battalion to Guantanamo as quickly as possible in phased tactical group arrivals at the Base. The unit was to be chopped to CINCLANT and further chopped to CINCLANTFLT and the <sup>1</sup>CC ENFLANT. This force was in place at the Base by the next day.

381. The concept for the defense of Guantanamo was spelled out on the 20th in a message from CINCLANT to his subordinate commanders, giving details of Change Number 2 to OPLAN 312-62, Annex L (the Defense of Guantanamo). The plan pointed out that defense of the Base was related to the air strikes provided for in OPLAN 312 in two ways. Execution of the basic plan would most likely cause Cuban attacks on the Base, or, on the other hand, Cuban attacks on the Base would be the occasion for executing the basic plan.

382. Several immediate tasks were described.

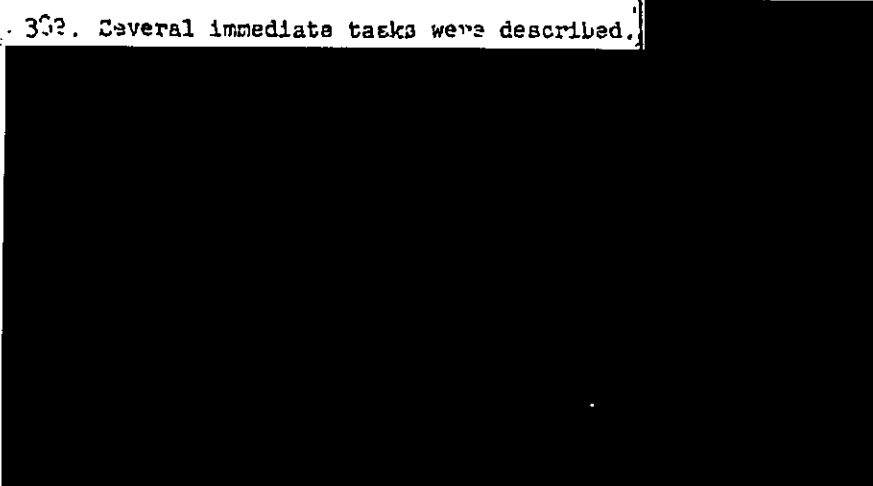

383. [As further reinforcements, the Plan Change presumed available the 5th MEB (-1 battalion) and another reinforced Marine infantry battalion.]

<sup>1</sup>Message CINCLANT to CMC, CINCPAC, 190618Z, October 1962, TOP SECRET.

TOP SECRET

~~TOP SECRET~~

TOP SECRET

~~TOP SECRET~~

384. In the event of preemptive air strikes against Cuba, it was anticipated in the Plan that all or part of the reinforcements would be deployed to the Base prior to the commencement of operations. The only limitation would be the necessity to preserve surprise.

385



385. The overall defense of the Base was assigned as a responsibility of the Commander of the Antilles Defense Command (COMANTDEFCON).<sup>1</sup>

387. The full air reinforcements were ordered up on the 21st when the JCS directed CINCLANT to transfer one Marine battalion from Camp Lejeune to Guantanamo in time for the first elements to arrive that same night and the last elements to close by the following evening, October 22. CINCLANT was further directed to land the afloat Marine battalion from the Carib PHIBRON on the afternoon of the 22nd. In both cases, warning having been received, the reaction times were much reduced from the requirements given above.

388. CINCLANT requested a change in the JCS orders in regard to the off-loading of the afloat battalion from the PHIBRON. Apparently the plan for the deployment of the

<sup>1</sup>Message CINCLANT to CINCPACFLT, COMANTDEFCON, 202034Z, October 1962, TOP SECRET.

TOP SECRET

- 141 -

~~TOP SECRET~~

TOP SECRET

ground force reinforcements made it desirable to get the PHIERON battalion ashore at the time of its scheduled arrival at 0800 on the morning of the 22nd, instead of waiting until the afternoon.<sup>1</sup> This request was granted by the JCS a few hours before the battalion arrived.<sup>2</sup>

389. Evacuation of dependents and noncombatants from the Base was ordered in accordance with plans, with embarkation Monday and sailing when loaded, and the last ship to clear Guantanamo no later than 1800 hours that same day.<sup>3</sup> The Commander Caribbean Sea Frontier (COMCARIBSEAFRON) was to provide air and surface escort for the evacuation ships and air escort for aircraft carrying out dependents until well clear of Cuba. Evacuation ships were to proceed at best speed on a track to keep as clear of Cuba as possible.<sup>4</sup>

390 The evacuation went very smoothly, the evacuees being given extremely short notice in order to maintain security almost until the last minute. A total of 2810 persons was evacuated aboard six aircraft and four ships, the last ship clearing the Base at 1730 hours (22 October) and the last aircraft half an hour later.<sup>5</sup>

391. One additional element of reinforcement to the Naval Base was a HAWK battery from the 3rd Light Antiaircraft Missile (LAAM) Battalion to improve low-altitude defense capabilities. The JCS had instructed the Marine Corps on the 19th, on CINCLANT's suggestion, to designate this Battalion for temporary deployment from PACOM to LANTCOM. Its initial destination was Cherry Point,<sup>6</sup> and after its

<sup>1</sup>Message CINCLANT to JCS, 220750Z, October 1962, TOP SECRET.

<sup>2</sup>JCS 6846 msg to CINCLANT, 221029Z, October 1962, TOP SECRET.

<sup>3</sup>Message JCS 6827 to CINCLANT, 211639Z, October 1962, TOP SECRET.

<sup>4</sup>Message CINCLANTFLT to COMCARIBSEAFRON, 220016Z, October 1962, SECRET.

<sup>5</sup>Message COMNAVBASE GIMO to COMCARIBSEAFRON, 222131Z.

<sup>6</sup>Message JCS 6780 to CNO, CMC, CINCLANT, CINCPAC, 191726Z, October 1962, TOP SECRET.

TOP SECRET

TOP SECRET

~~TOP SECRET~~

arrival there, CINCLANT decided to send one battery on to Guantanamo by Marine aircraft, commencing October 25.<sup>1</sup>

392. [The reason for this additional air defense deployment may lie in a rather curious message from CINCLANT to CINCLANTFLT on the 24th to the effect that in the event OPLAN 312 were not directed, but Cuba attacked Guantanamo, CINCLANTFLT would be directed to provide air support to COMANTDEFCON for the defense of the Base.<sup>2</sup> The thought is directly contrary to the planning presumption that any attack on the Base would provoke execution of OPLAN 312, as spelled out in CINCLANT's message to CINCAFLANT and COMANTDEFCON on the 20th.]

393. A similar disparity appears between this CINCLANT presumption and the original JCS blockade of Cuba order.<sup>3</sup> This order stated that establishment of the blockade might lead to Cuban attack on the Base or on planes and ships entering or leaving. Any attacks against the Base or ships or aircraft approaching or leaving were to be repulsed with offensive action "against the attacking planes or ships or ground installations." However, a major constraint on the Base Commander and CINCLANT was built in by the next statement to the effect that "only in the event that it is absolutely necessary in order to protect U.S. lives will U.S. forces be authorized to attack the bases from which the aircraft or ships are operating." The order of magnitude of those U.S. casualties which might have to be suffered before such authorization was given was not indicated.

<sup>1</sup>Message CINCLANT to JCS, 250302Z, October 1962, SECRET.

<sup>2</sup>Message CINCLANT to CINCLANTFLT, 241618Z, October 1962, TOP SECRET

<sup>3</sup>Message JCS 6848 to CINCLANT, 221111Z, October 1962, TOP SECRET.

TOP SECRET

- 143 -

~~TOP SECRET~~

TOP SECRET

~~TOP SECRET~~

394. This order was itself amended by the JCS on 230009Z to read "...will U.S. forces be authorized by the JCS to attack ...," thereby further tightening control. The lack of precision in regard to operational responsibility was compounded by a further message, presumably designed to clarify the situation, from the JCS to CINCLANT on the 23rd. This transmitted a message from the Secretary of Defense to the Commander at Guantanamo; that the Secretary wished it to be understood that the blockade of Cuba order as modified by the amendment, gave the Commander Guantanamo "clear authority to respond instantly to attack by Cuban forces."<sup>1</sup>

395. However, the last mentioned message had barely been sent before the JCS again seemed to change its mind or its emphasis. In a message three hours later the JCS told CINCLANT to delegate authority, previously reserved to themselves, to COMNAVBASE GIMO to order strikes against bases from which Cuban attacks on Guantanamo had been launched.<sup>2</sup> This was certainly a major extension of the Base Commander's authority, but the authority clearly had to be kept within the context of the obvious JCS intent to control U.S. responses, as evidenced in the body of previous messages. The full extent of the Base Commander's authority was still not spelled out. The maintenance of ultimate control in Washington was further implied by the establishment around this time of a direct communication link between the White House and the Naval Base.

396. Above all, neither these messages nor the blockade of Cuba order specified just how large an attack on the Base would be tolerated before U.S. forces from outside the Base would be employed. In short, the fairly clear relationship between the defense of the Naval Base and OPLAN 312, as defined by CINCLANT, was really not so clear in the eyes of the JCS.

<sup>1</sup>Message JCS 6912 to CINCLANT, 232053Z, October 1962, SECRET.

<sup>2</sup>Message JCS 6916 to CINCLANT, 232304Z, October 1962, SECRET.

TOP SECRET

- 144 -

~~TOP SECRET~~

TOP SECRET

~~TOP SECRET~~

397. At any rate, total Base personnel numbered some 5863 men by the morning of the 25th,<sup>1</sup> and the HAWK battery that arrived that day further increased the total. The Base remained on a tense alert during the week, but the lack of any obvious hostile moves by Cuban forces encouraged confidence. The water supply was not tampered with nor were Cuban workers at all prevented from entering the Base.

The Air Defense of the Southeastern United States

398. Measures to improve the air defenses in the southeastern corner of the U.S. were among the first U.S. military actions to be taken in the crisis. In fact, as early as October 9 the obviously worsening situation in the Caribbean had led to the deployment by CINCLANTFLT of an F4H interceptor squadron to Key West, where it was chopped to CINCONAD control for air defense.<sup>2</sup> However, it was not until the 17th that the JCS directed CINCONAD to take action immediately for the necessary augmentation of the air defenses of the southeastern U.S.<sup>3</sup> On the same day, CINCLANTFLT alerted shore-based Navy and Marine fighter squadrons to be ready to augment CONAD forces in the air defense role in that region.<sup>4</sup>

399. CINCONAD then began to organize the build-up of the air defenses. He proposed a series of actions which could be completed by October 20th if approval were given immediately, and which involved the deployment of additional fighter-interceptor squadrons to Patrick, McCoy, Tyndall and Homestead Air Force Bases and Key West Naval Air Station in Florida. He asked also for immediate assistance in the matter of JCS approval of rules of engagement for the support of OPLAN 312, for authority to establish a Military Emergency Zone (MEZ), as proposed by his message of October 5, and for further authority to implement security control of air

<sup>1</sup>Briefing to the CJCS, 0600 EDT, October 25, 1962, TOP SECRET.

<sup>2</sup>Message CINCLANT to JCS, 091618Z, October 1962, CONFIDENTIAL.

<sup>3</sup>Message JCS 6731 to CINCONAD, 171408Z, October 1962, TOP SECRET.

<sup>4</sup>Message CINCLANT to JCS, 172256Z, October 1962, TOP SECRET.

TOP SECRET

- 135 -

~~TOP SECRET~~

TOP SECRET

~~TOP SECRET~~

traffic in the MEZ. He further requested a 4-battery HAWK battalion for employment at Key West NAS, suggesting that the most readily available Army or Marine unit should be considered.

400. Finally, since his plan proposed moving into the SAC bases in Florida, he requested full SAC support of those deployments.<sup>1</sup>

401. The JCS promptly approved most of CINCONAD's proposals for implementation. He was directed: to deploy 14 F-102's to Homestead (for a total there of 18); to deploy 6 F-106's to Patrick (total there 12); that no additional deployments could be made to Tyndall because the base was already saturated; that VF 41 of 12 F4H would remain under his control; that 6 additional RC-121 AEW&C aircraft should go to McCoy; that VFAW 3 Detachment at Key West would be augmented with additional Navy crews. No HAWK unit was to be made available at this time.<sup>2</sup>

402. SAC immediately offered to provide the necessary facilities at McCoy and Homestead.<sup>3</sup>

403. Within less than a day, the JCS reversed itself on the matter of the HAWK battalion, and informed CINCONAD that the Army had been ordered to expedite the readiness status of a HAWK battalion at Fort Meade. CINCONAD was authorized to direct the move to Key West at his discretion and to agree upon rules of engagement with CINCLANT.<sup>4</sup> CINCONAD immediately requested the CG ARADCOM (Ent AFB) to take the necessary action with CONARC for the deployment of the 6th Battalion, 65th Artillery to Key West, to be under CINCONAD operational control upon arrival there.<sup>5</sup>

<sup>1</sup>Message CINCONAD to CSAF, CINCSAC, 181800Z, October 1962, TOP SECRET.

<sup>2</sup>Message JCS 6761 to CINCONAD, 182204Z, October 1962, TOP SECRET.

<sup>3</sup>Message SAC to CINCONAD, 190135Z, October 1962, TOP SECRET.

<sup>4</sup>Message JCS 6779 to CINCONAD, 191723Z, October 1962, TOP SECRET.

<sup>5</sup>Message CINCONAD to CG ARADCOM, 200355Z, October 1962, TOP SECRET.

TOP SECRET

- 146 -

~~TOP SECRET~~



TOP SECRET

~~TOP SECRET~~

404. The move took a surprisingly long time and the HAWK battalion was not fully operational at Key West until the night of the 27th.<sup>1</sup>

405. Despite the JCS-approved augmentations, doubts persisted about the air defense problem, and on the 19th the JCS asked CINCONAD's judgment regarding the overall adequacy of the air defenses of the southeastern U.S. and of the whole U.S. in the light of the augmentation of the southeast. CINCONAD was asked whether approval should be sought for the call-up and assignment to him of reserve forces interceptor units, and whether these units should be drawn from the Gulf Coast area only or nationwide. The JCS also asked if he had any requests for further improving the air defenses of the southeast which had not yet been considered.<sup>2</sup>

406. In response, CINCONAD declared he felt the CONAD forces deployed to the southeast were adequate, although radar capability below 500 feet was limited as were communications facilities at Key West. Nor did he think the deployments had appreciably affected overall CONUS defense capability. He recommended the call-up of all Air National Guard (ANG) interceptor units, or, if not possible, of the Gulf Area ANG. He also suggested that the redeployment of some regular interceptor units into ANG bases could be made without degrading the overall air defense posture. Beyond that, he had no further requests for the improvement of air defense measures.<sup>3</sup>

<sup>1</sup>Briefing to CJCS, 2100 EDT October 27, 1962, TOP SECRET.

<sup>2</sup>Message JCS 6762 to CINCONAD, 191930Z, October 1962, TOP SECRET.

<sup>3</sup>Message CINCONAD to JCS, 201722Z, October 1962, TOP SECRET.

TOP SECRET

- 147 -

~~TOP SECRET~~

TOP SECRET

~~TOP SECRET~~

407. CINCLANT at this point recommended another air defense measure, in response to a JCS query of the 19th, namely, the mobilization of the Puerto Rican Air National Guard (PRANG) when the blockade was established. He proposed that the PRANG be placed on a NORAD Type Category I status,<sup>1</sup> and this was so directed by the JCS.<sup>2</sup>

408. The movement of fighters into Florida brought in 62 additional aircraft for CONAD, raising the total available to CINCONAD under the operational control of the Montgomery Air Defense Sector to 183. Of these, 154 were based in Florida, south of a line Panama City-Jacksonville. Twenty-two aircraft were kept on a five-minute alert, 72 on a fifteen-minute alert. Four to six were maintained on airborne alert patrol around the Florida Peninsula, augmented by five mdrs for the two hours before and after first light.<sup>3</sup> During the President's address to the nation at 1900 EDT on the 22nd, 22 interceptors were airborne in the event of some rash act from Cuba during or immediately following the address.<sup>4</sup>

409. Despite the affirmation by CINCONAD on 201722Z that he had no further requests for the improvement of air defense measures, the subject was raised again in a telecon with the JCS late on the 20th, as a result of which CINCONAD was directed to reexamine his air defense plans for the Southeast. This time the dam broke, and CINCONAD began to put forward massive requests. The basis of this

<sup>1</sup>Message CINCLANT to JCS, 201734Z October 1962, TOP SECRET.

<sup>2</sup>Message JCS 6893 to CINCLANT, CSAF, 230411Z, October 1962, SECRET.

<sup>3</sup>Briefing to CJCS, 0800 EDT, 24 October 1962, TOP SECRET.

<sup>4</sup>H. USAF Chronology of the Cuban Crisis, prepared by USAF Historical Division Liaison Office, TOP SECRET, Volume 1, page 15.

TOP SECRET

- 146 -

~~TOP SECRET~~

TOP SECRET

~~TOP SECRET~~

JCS insistence upon urging CINCONAD to make new evaluations is unknown, and is doubly curious since most of his requests were from this point on not approved.

410. However, it may be inferred that the basis lay in the ambiguous attitude toward the threat of a Cuban nuclear attack. The Cuban HE threat hardly merited such activity and measures as CINCONAD proposed, and the JCS seem to have thought so, too. However, they kept seeking reassurance and their concern over the concentration of OPLAN 312 aircraft could hardly have arisen from the Cuban HE threat. At the same time, the likelihood of a Cuban nuclear attack as an opening move was judged as extremely low.

411. CINCONAD's first reply to the latest JCS instruction recommended: deployment of 18 F-102's from Webb AFB, Texas, to Homestead, to be in place by 1600 local October 21; 12 F-106's from Selfridge AFB, Michigan, to Patrick, to be in place by 1600 local October 21, the federalizing of 5 ANG units mostly from the Gulf area; that he be given authority to coordinate with the FAA in regard to air traffic control in the southeast; that he needed HAWK units for the defense of Homestead, MacDill, and Patrick and also defense against low-altitude attack on the coastal metropolitan areas<sup>1</sup>. It is interesting to note that this is the first explicit mention of possible Cuban attack on U.S. cities.

412. In reply, the JCS granted only his two aircraft deployment requests.<sup>2</sup> However, an hour later CINCONAD put forward his requirements for missile units, both HAWK

<sup>1</sup>Message CINCONAD to JCS 210400Z, October 1962, TOP SECRET.

<sup>2</sup>Message JCS 6833 to CINCONAD, 211920Z, October 1962, TOP SECRET.

TOP SECRET

- 147 -

~~TOP SECRET~~

~~TOP SECRET~~

TOP SECRET

and HERCULES. In addition to the HAWK battalion already assigned him, he asked for eight more battalions to provide adequate high-level defense for Homestead, Patrick and MacDill Air Force Bases, the population contiguous to Homestead (Miami) and MacDill (Tampa/St. Petersburg), and the population at Houston, New Orleans, Mobile, Jacksonville.

413. [If less than eight battalions could be made available, CINCONAD proposed to use whatever units were furnished to protect the three large airbases as a first priority, and to dispose any remaining missile units to provide minimal protection to the population centers. A minimum of three and a half battalions was considered necessary for this reduced-scale effort.]

414. CINCONAD further requested the 2nd Battalion, 52nd Artillery, a NIKE-HERCULES unit currently stationed as a STRAC unit at Fort Bliss, for deployment to the Miami-Homestead area. If this unit could be obtained, it would reduce the eight battalions of HAWK required for the full-scale defense to seven, but would not reduce the three and a half required for the reduced-scale effort.<sup>1</sup>

415. A day later CINCONAD followed up these requests with his requirements for low-altitude defense of the areas described in his message of the 21st, asking twelve battalions of 40mm guns. If less than the full amount could be furnished, he proposed using what he received on the same priority basis as the HAWK units requested.<sup>2</sup>

416. [Apparently a telecon on the 22nd indicated to CINCONAD that his requests for HAWK could not be met, and]

<sup>1</sup>Message CINCONAD to JCS, 212032Z, October 1962, TOP SECRET.

<sup>2</sup>Message CINCONAD to JCS, 221907Z, October 1962, TOP SECRET.

TOP SECRET

- 150 -

~~TOP SECRET~~

TOP SECRET

~~TOP SECRET~~

[that possibly three HAWK battalions and one of NIKE-HERCULES would be made available to him. He proposed therefore disposing the HERCULES battalion and one Army HAWK battalion to protect Miami-Homestead, while the two Marine HAWK battalions would be deployed by batteries to cover Patrick, MacDill, Houston, New Orleans, Mobile, and Jacksonville. Patrick and MacDill each were to get two batteries, the other locations one each.]

417. The HAWK units available to CINCONAD shrank even more, and a JCS order on the 23rd directed the Army to provide only one HAWK battalion to CINCONAD. CINCSTRIKE was directed to provide one HERCULES battalion, and CINCONAD was told to make the best possible deployment in the Miami-Homestead area.<sup>2</sup>

418. Some confusion arose over the JCS order in regard to deployment, CINCONAD understanding the JCS message, reinforced by a telecon earlier, as meaning both battalions should be put in the Miami-Homestead area. He proposed instead to place the HERCULES battalion in that area to cover Homestead first and the contiguous population second. The HAWK battalion would be broken up to cover Miami-Homestead, Patrick, and MacDill and its contiguous population. Such a deployment would provide some protection for the principal critical military installations involved, for the population in the Miami-Homestead area, and at least incidental protection for the population contiguous to MacDill.<sup>3</sup> These deployments were approved by the JCS the same day.<sup>4</sup>

<sup>1</sup>Message CINCONAD to JCS, 222115Z, October 1962, TOP SECRET

<sup>2</sup>Message JCS 6913 to CINCONAD, CINCSTRIKE, CSA, CNO, CMC, CSAF, 232121Z, October 1962, SECRET.

<sup>3</sup>Message CINCONAD to JCS, 240725Z, October 1962, TOP SECRET.

<sup>4</sup>Message JCS 6937 to CINCONAD, 241717Z, October 1962, SECRET.

TOP SECRET

- 101 -

~~TOP SECRET~~

TOP SECRET

~~TOP SECRET~~

419. The SAM problem having been disposed of, the 40mm gun issue took over the role as chief subject of communication. Presumably CINCONAD's request for twelve battalions of AAA AW was found to be grossly in excess of what could be provided. The JCS instructed him to give priority in proposed deployments to Key West and Homestead, and asked his recommendations for disposition of units<sup>1</sup> excess to these priority requirements.

420. An interesting change in priorities appeared at this point. The JCS request to CINCONAD for his estimate of AAA AW requirements had been based upon consideration of both the MIG and IL 28 threat to the southeast. On the 25th, the JCS reported to CINCONAD that they had now the benefit of a report from a representative (this was the Inspector General of the Air Force) sent to Florida to observe the measures taken to improve dispersion and active air defense capabilities in the area. He indicated that the MIG threat was a very marginal one in view of the recently taken air defense steps. On the other hand, the IL 28 threat, both high and low level, which would develop as the IL 28's became operational, had not yet been fully evaluated. Therefore, CINCONAD was asked to reevaluate his AAA AW priority requirements for airfield defense in view of the reduced MIG threat, and to do the same for populated areas<sup>2</sup> to meet the IL 28 threat when it developed.

421. The only 40mm force being sent was an improvised battery from Fort Bliss to Key West, which the JCS felt would be adequate to cover his Key West requirement. This

<sup>1</sup>Message JCS 5928 to CINCONAD, 2-07492, October 1952, TOP SECRET.

<sup>2</sup>Message JCS 5965 to CINCONAD, 252020Z, October 1952, SECRET.

TOP SECRET

~~TOP SECRET~~

~~TOP SECRET~~

TOP SECRET

unit had been ordered from Bliss by COMARC without previous knowledge of the JCS, but the timing was fortunate, and the airlift of the sixteen tracked vehicles with 40mm guns was completed at 260130Z.<sup>1</sup>

422. CINCONAD, by the 28th, indicated that his estimated requirements had by now risen to 14½ battalions of 40mm guns, with 8½ battalions to cover Miami-Homestead, Key West, Patrick, MacDill-Tampa, and McCoy-Orlando. The remaining six units would cover Houston, New Orleans, Mobile, and Jacksonville. The request was quite unrealistic, since that number of active units simply didn't exist. It would have required calling up some 9500 reserve personnel to provide these units.<sup>2</sup> CINCNOAD (sic)<sup>3</sup> realized that the 40mm guns would have extremely limited value, and he appreciated the mobilization problem, but still felt the guns would make some contribution to the defense.

423. In connection with the possible IL 28 threat against cities, the JCS on the 24th sought CINCNOAD's (sic)<sup>4</sup> comments on possible civil defense actions in Florida. He felt the population in the area should have the benefit of an announcement by the President or the Secretary of Defense to the effect that the military build-up was precautionary, and by virtue of it the probability of attack was lessened. He would urge the population to continue a normal life, and suggested increased news coverage be made available. Certainly no drastic steps, such as blackout, or CONELRAD, or evacuation were required.<sup>5</sup>

<sup>1</sup>JCS Cuba SITREP 4-62, 260400Z, October 1962, TOP SECRET.

<sup>2</sup>J-3 Master Check List for Cuban Operations, 29 October 1962, TOP SECRET.

<sup>3</sup>Apparently a clerical error - the proper designation for the unilateral U.S. command capacity involved should have been "CINCONAD."

<sup>4</sup>Ibid.

<sup>5</sup>Message CINCNOAD (i.e., properly "CINCONAD") to CJCS, 242328Z, October 1962, SECRET.

TOP SECRET

- 153 -

~~TOP SECRET~~

TOP SECRET

~~TOP SECRET~~ E

424. The problems discussed thus far have all pertained to an aircraft threat. Yet the whole crisis revolved primarily around a missile threat. Meeting this posed a much more severe set of problems which were handled on an ad hoc basis. The nub of the problem lay in the fact that the U.S. had no missile detection and tracking radar coverage for the area of the Caribbean. To meet the possibility, no matter how remote it seemed, that the Cubans might launch missiles against the U.S., HQ USAF was directed to place an FPS-49 BMEWS tracking radar at Moorestown, New Jersey, on 24-hour operation to provide some detection capability. This facility, operated by the Radio Corporation of America, normally was used as a research and development radar under contract to the Air Force Systems Command and as a Spacetrack sensor under operational control of NCRAD. It could provide a potential warning of five minutes for an IRBM launch from Cuba targeted on Washington.

425. In addition, radar trackers at Laredo, Texas, and Thomasville, Georgia, also were aligned for Cuban missile warning, and Navy picket ships tied into the air defense net for added low-level aircraft coverage.<sup>1</sup>

Other Air Defense Issues

426  CIA

<sup>1</sup>Hq USAF Chronology of the Cuban Crisis, TOP SECRET.

TOP SECRET

~~TOP SECRET~~



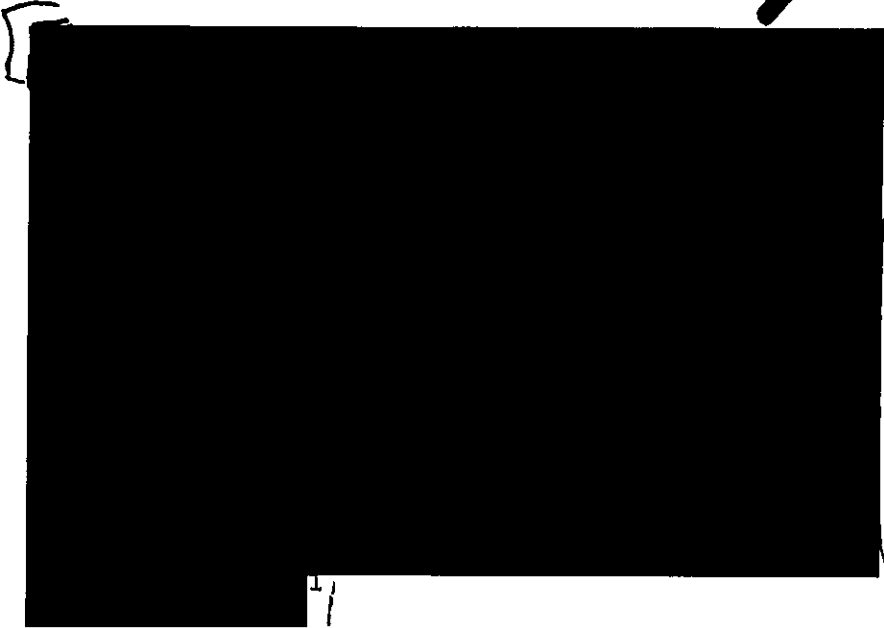

b1-1

427.

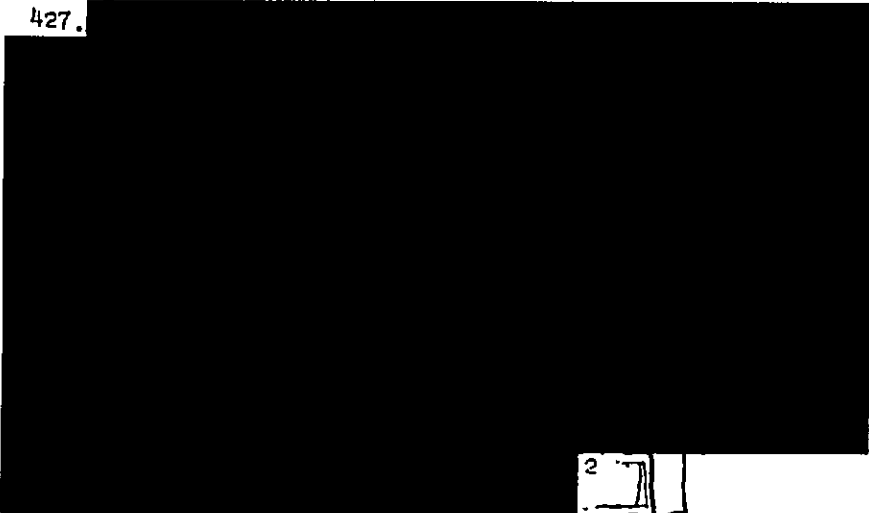

2

428. Quite clearly this was one of the points in the crisis, of which there were several, at which the requirements for contingency operations against Cuba tended to clash with the requirements of general war preparation. The JCS position, at least as expressed to CINCOMAD, avoided the dilemma rather than seeking to clarify it by a decision.

1 Message CINCOMAD to JCS, 282345Z, October 1962, TOP SECRET.

2 Message JCS 7057 to CINCOMAD, 280114Z October 1962, TOP SECRET.

TOP SECRET

~~TOP SECRET~~

429. Another collateral issue concerned the efforts to establish air traffic control in Florida. On the 20th, CINCLANT urged the JCS to approve his concept of a military emergency zone, as proposed in early August, in the event of operations against Cuba, and to grant him authority to establish it.<sup>1</sup> The JCS, while approving the concept, nevertheless withheld authority to establish the MEZ, on the basis that it was not yet necessary. The Air Force was to coordinate with the FAA for corridor reservations into Florida staging areas, but no implementation was allowed until OPLAN 312 was executed.<sup>2</sup>

430. It will be recalled that CINCONAD had asked for similar authority on the 18th. It is unclear as to whether these two requests were coordinated, although the respective concepts were fairly similar.

431. Here the JCS faced the dilemma of withholding a vital defensive measure until the last minute in order to avoid worsening the existing crisis. Every precaution was being taken not to provoke the Cubans into a rash act or alarm the Soviets by our preparations.

432. Initial control steps were undertaken, however, and effective 1800 EST 24 October, the FAA restricted the flight of civil aircraft in southern Florida if the aircraft did not have an approved military/FAA flight plan and possessed functioning communications for two-way contact with the air traffic control facilities.<sup>3</sup>

#### Deployment of Air Strike Forces

433. The movement of tactical air forces into position for the execution of OPLAN 312-62 was one of the smoothest operations of the crisis. These forces rapidly achieved full readiness posture

<sup>1</sup> Message CINCLANT to JCS, 202350Z, October 1962, TOP SECRET.

<sup>2</sup> Message JCS 6022 to CINCONAD, CINCLANT, CASF, 213010Z, October 1962.

<sup>3</sup> JCS Cuba SITREP 3-62, 250400Z, October 1962, TOP SECRET.

TOP SECRET

156

~~TOP SECRET~~

TOP SECRET

~~TOP SECRET~~

and remained throughout the crisis prepared to implement all or any of the several missions of OPLAN 312. Their role in this mission was critical and upon their success in eliminating Cuban missile and air capability and in crippling Cuban mobile forces would depend largely on the success of the ground assault. They were to have [redacted] in which to do their job before the assault landings were made. While TAC aircraft crowded into Florida bases, they were joined by Marine attack squadrons meant to support the Marine amphibious assaults. At sea [two] carrier divisions took position off Cuba to support the landings and to aid the defense of Guantanamo.

434 While the actual deployment of aircraft did not begin until the 21st, preparations were under way three days earlier. On the 18th, the JCS granted CINCLANT authority to release special intelligence planning information for use at air crew level, thus permitting pilot briefings and target assignments.<sup>1</sup>

435 On that same day, CINCAFLANT began a series of efforts to increase his capability by arranging the return of current TAC commitments in the Pacific, namely the units on Okinawa and in Thailand, the latter sent there as part of the U.S. deployment in May 1962. As a result of the situation in the Caribbean, CINCAFLANT requested CINCLANT's support in getting these forces returned. He emphasized that the [35] F-100's and their crews could be a vital asset to the success of OPLAN 312.<sup>2</sup> CINCSTRIKE similarly requested the return of these units,<sup>3</sup> and the case was

<sup>1</sup>Message JCS 6715 to CINCLANT, 182356Z, October 1962, TOP SECRET.

<sup>2</sup>Message CINCAFLANT to CINCLANT, 181515Z, October 1962, TOP SECRET.

<sup>3</sup>Message CINCSTRIKE to JCS, 190037Z, October 1962, TOP SECRET.

TOP SECRET

~~TOP SECRET~~

TOP SECRET

~~TOP SECRET~~

backed up by CINCLANT himself.<sup>1</sup> However, either for political reasons concerned with Southeast Asia or for the desire to keep a reserve at hand in PACOM lest the Bloc react to the U.S. initiative in Cuba by a move in Southeast or East Asia, the JCS declined to return the F-100's.

436. CINCAFLANT's order to his subordinate commanders to move went out at noon on the 21st. He outlined instructions for the deployment of AFLANT units to designated employment bases in "an orderly but not mass deployment." Every effort was to be made to discourage indications of a mass build-up. Accordingly, aircraft were to deploy in flights of four only, and in the case of deployments from bases located near cities, deployments were to be no more frequent than one each hour.<sup>2</sup>

437. Within the next day large numbers of aircraft poured into the five Florida bases, Homestead, Key West, MacDill, McCoy, and Patrick, and Shaw in South Carolina. Most were Air Force TAC planes, but the JCS on the 21st also approved the move from Cherry Point, North Carolina, to Key West of a Marine Air Group.<sup>3</sup>

438. However, no more had the deployment into southern Florida begun before the JCS began to have second thoughts about the wisdom of such a huge concentration on a few bases, and thus began the major policy problem of the AFLANT deployment. This had been foreseen in some quarters at least. The Commander of the 19th Bombing Wing at

<sup>1</sup>Message CINCLANT to JCS, 191436Z, October 1962, TOP SECRET.

<sup>2</sup>Message CINCAFLANT to Subordinate Commanders, 211233Z, October 1962, TOP SECRET.

<sup>3</sup>Message JCS 6831 to CINCLANT, 211819Z, October 1962, TOP SECRET.

TOP SECRET

- 158 -

~~TOP SECRET~~

~~SECRET~~

~~TOP SECRET~~

stead had indicated to SAC on the 19th that the planned deployment for OPLAN 312 called for a minimum of [238] <sup>1</sup> craft to be based at Homestead.

439 Analogies to Pearl Harbor may have appeared uncommonly real, and consequently the JCS notified CINCLANT around noon on the 22nd that "there was concern" about the heavy concentration at Homestead and Key West. He was authorized to relax his readiness to execute OPLAN 312 from [six to twelve hours] and was asked to consider thinning out attack aircraft at these two bases. In short, the JCS felt the danger of concentration outweighed the [six-hour] <sup>2</sup> advantage which concentration permitted.

440 CINCLANT called CINCAFLANT to relay this information, and CINCAFLANT's attitude toward the JCS suggestion was quite negative. He pointed out that the move to forward bases had been undertaken as a result of JCS action on the evening of the 20th. At that time the risk of conventional attack against the Florida bases had been ~~operational~~, assessed, and accepted. He knew of no intelligence since received which would materially alter this risk of conventional limited attack. As to nuclear attack, the risk may have increased as a result of recent additional intelligence. However, he did not believe anyone thought that the nuclear threat before we attacked was a real one. If it were, he felt we were approaching the whole Cuban operation with the wrong strategy and wrong weapons. He was referring here, it seems certain, to the threat of possible Cuban use of nuclear weapons on the island, rather than strikes launched from the Soviet Union.

<sup>1</sup>Message 157n Enrb 14g Homestead to SAC, 191930Z, October 1962, TOP SECRET.

<sup>2</sup>Message JCS 6051 to CINCLANT, 221341Z, October 1962, TOP SECRET.

~~TOP SECRET~~

- 159 -

~~TOP SECRET~~

441. Consequently, CINCAFLANT's position was that any redeployment of some strike forces would seriously jeopardize his ability to deliver a maximum strike at dawn on the 23rd.<sup>1</sup> This strike timing, it should be added, was the one toward which CINCAFLANT had been striving in readiness terms ever since the crisis activity started.

442. CINCLANT fully supported his subordinate air commander's position. He pointed out to the JCS that approved planning for OPLAN 312 execution within [twelve hours] required prepositioning of forces at Homestead and Key West. All nonessential aircraft had been removed from Key West to clear the decks. He agreed completely with CINCAFLANT's comments, adding that they applied to all air units involved in OPLAN 312, and that disruption of those forces at this time would seriously affect our ability to deliver coordinated attacks within the required time frame.<sup>2</sup>

443. This message temporarily stilled the issue, but only temporarily. It was bound to recur as the crisis week advanced and airplanes continued to pour into the bases of the southeast. The build-up and concentration can best be illustrated by a table drawn from the JCS Cuba SITREP:

<u>DTG</u>	<u>Numbers of Aircraft</u>	<u>Base</u>
230400Z	141 (363 attack) <sup>3</sup>	Homestead - 25
240400Z	515 (448 attack)	Key West - 66
250400Z	594 (590 attack) - as of this date	MacMill - 291
260400Z	782 (655 attack)	Shaw - 6
270400Z	(576 attack)	McCoy - 162
		Patrick - 24

<sup>1</sup>Message CINCLANT to JCS, 222150Z, October, 1962, TOP SECRET.

<sup>2</sup>Message CINCLANT to JCS, 222150Z, October, 1962, TOP SECRET.

<sup>3</sup>JCS Cuba SITREPS, October 23-27, 1962, TOP SECRET.

444. There was always a healthy reserve available over and above what the OPLAN 312 missions called for. As of 0800 on the 28th there were available [573] aircraft to cover the missions requiring [465].<sup>1</sup> In addition, there were the naval aircraft which on the 29th numbered [123] available with [114] required by the OPLAN.<sup>2</sup>

445. Very early on the 25th the CJCS, presumably armed with the above figures, requested CINCLANT to give an estimate of the impact on the [twelve-hour] readiness status for implementation of OPLAN 312 if forces in the forward areas were reduced by 50 percent.<sup>3</sup> CINCLANT, in his reply, referred to the cogent arguments of CINCPACFLT in the earlier exchange of messages on the base vulnerability issue, and stressed that the reduction of vulnerability accruing from dispersal of the force would be far outweighed by the increased cost in manpower and resources and degradation of offensive capability.<sup>4</sup>

446. CINCLANT followed the same line of argument in response the next day to presumably telephoned JCS inquiries as to where redeployed aircraft would go if a 50 percent redeployment from Homestead and Key West were ordered, and how would the OPLAN be affected. The latter question seems superfluous, since CINCLANT had twice already made known his position on it. In reference to the first query, he stated that in most cases the planes would return to their home bases. This would include support equipment personnel, and thus would impose a heavy strain on airlift capability.

<sup>1</sup>Briefing to the CJCS, 0800 EDT, October 28, 1962, TOP SECRET.

<sup>2</sup>Briefing to the CJCS, 0300 EDT, October 23, 1962, TOP SECRET.

<sup>3</sup>Message JCS 6963 to CINCLANT, 250026Z, October 1962, TOP SECRET.

<sup>4</sup>Message CINCLANT to JCS, 251000Z, October 1962, TOP SECRET.

P SECRET

~~TOP SECRET~~

47. CINCLANT added parenthetically that he was taking  
eps to improve local dispersal at the bases.

448. As to the second query, he remained adamant in his  
estimate that such a move would heavily influence his  
ability to launch OPLAN 312. With the removal of essential  
support equipment as well as the aircraft, CINCAFLANT would  
be for all practical purposes returning to the pre-emergency  
posture.<sup>1</sup>

449. This last statement seems somewhat of an exaggeration,  
since a 50 percent reduction on that day, the 26th, would  
still leave him [330] attack aircraft on the Florida bases.

450. Despite this firm position, the next day CINCLANT  
reported to the JCS that he was taking several steps to  
reduce the concentration. He had ordered APLANT to reduce  
the number of Air Force and Marine aircraft by 15 percent  
by rotation to home stations or other stations. LAITFIT  
had been directed to relocate one fighter squadron from  
Key West. These actions would reduce the number of air-  
craft by approximately [30] at Key West, [34] at MacDill, [27]  
at Homestead, and [22] at McCoy, for a total reduction of [113].  
Furthermore, he was recommending the relocation of [eight]  
aircraft of a VFAW squadron assigned to CINCONAD from Key  
West. The basis for this order apparently lay in the [116]  
plane extra strength ([579] total available) over the OPLAN  
requirement of [465]. However, after CINCLANT's vigorous  
efforts to maintain maximum strength at hand, it is  
curious that he should voluntarily accept a reduction.

<sup>1</sup>Message CINCLANT to JCS, 260452Z, October 1962, TOP SECRET.

TOP SECRET

- 162 -

~~TOP SECRET~~



SECRET

~~TOP SECRET~~

51. Maximum local dispersal of the remaining aircraft  
a being effected, and CINCLANT did not consider that his  
adness posture should be further reduced by additional  
locations.<sup>1</sup>

452. It would appear that these proposals did not meet  
1th JCS approval, they having also asked CINCCNAD's views  
in CINCLANT's recommendations. The 15 percent reduction  
was suspended, apparently on the 28th. It was to be under-  
taken thereafter only at JCS direction. Presumably the  
suspension was related to the Soviet concession of that  
morning.

453. This exchange of messages coincided with the Soviet  
concession which ended the first phase of deployments.  
One other item of interest may be added in connection  
with air strike force deployments. Sometime on the 28th  
the naval carrier divisions were [both] withdrawn from the  
south of Cuba after submarine locations indicated possibly  
increased undersea threat.<sup>2</sup>

#### Marshalling Assault Forces

454. The account of the assault forces role in the crisis  
involves Army and Marine forces. By the close of the  
first phase, all Marine forces assigned to OPLANs 314/316  
were deployed and at sea. [Most of the Army's activity  
involved preparations for deployment rather than actual  
movement, so that by the end of the entire crisis only  
some 27,000 Army personnel had actually been deployed.]<sup>3</sup>

<sup>1</sup>Message CINCLANT to JCS, 270250Z, October 1962, TOP SECRET.

<sup>2</sup>Briefing for CJCS, 2100 EDT, October 26, 1962, TOP SECRET.

<sup>3</sup>The U.S. Army in the Cuban Crisis, prepared in the Office  
of the Chief of Military History, TOP SECRET.

TOP SECRET

- 153 -

~~TOP SECRET~~

455. In order to understand the purposes of the assault forces' preparations in this period, it is useful to have some comprehension of the nature of OPLAN 316 in its tactical details. Since OPLAN 314 was dropped from consideration on October 24, it will be profitless to concern ourselves with its characteristics.

456. The concept of operations was simple. Airborne forces would seize and hold [redacted] [redacted] A continued build-up of Army forces would come through [redacted] until these forces were strong enough to seize the [redacted] and then permit landing of designated surface elements of an Army Task Force through [redacted]

457. Simultaneously a Naval Task Force would make an amphibious assault [redacted] putting ashore most of the 2nd Marine Division. Other Army forces would also land here through the Marine bridgehead.

Marine Deployments

458. Marine forces moved toward Cuba from both LANTCOM and PACOM. As has been recounted earlier, [two] battalions from LANTCOM and [one] from the 5th MEB in California were landed by sea or air at Guantanamo on the 22nd and 23rd. With two BLT's in Guantanamo and one in the Mediterranean (CINCLANT's suggestion that this be withdrawn for use in Cuban operations was vetoed by the JCS as politically unwise), the 2nd Marine Division had [six] remaining BLT's. PACOM was therefore called upon early to provide further support.

459. The JCS ordered a Marine HAWK battalion from Twenty-Nine Palms, California, to Cherry Point on the 19th.

~~TOP SECRET~~

TOP SECRET

for temporary deployment, part of the unit scheduled for duty at Guantanamo.<sup>1</sup> However, this battalion did not close on Cherry Point until the 25th.<sup>2</sup>

460. The 5th MEB was alerted on the 19th, when the JCS ordered CINCPAC to assemble amphibious shipping in embarkation ports in preparation for possible orders to chop the unit's sea echelon to CINCLANT. However, the Brigade was not to be loaded until the JCS directed.<sup>3</sup>

461. On the 22nd, the JCS instructed CINCPAC to load the Brigade as soon as possible and to chop the force to the temporary operational control of CINCLANT.<sup>4</sup> In the meantime, CINCLANT had raised with the JCS the matter of the missing battalion from the 5th MEB, which had been sent to reinforce Guantanamo. This reduced the Brigade to [three] BLT's, while its role in [OPLAN 316] was predicated upon its containing [four] BLT's. CINCLANT suggested the Brigade be reconstituted by the addition of another BLT.<sup>5</sup> His proposal was accepted by the JCS who instructed CINCPAC to reconstitute the Brigade.<sup>6</sup> The JCS SITREP for the next morning reports that a new battalion had already been selected.

432. Air support for the Brigade was covered by the instruction to CINCPAC to transfer operational control in place to CINCLANT of [two] CONUS-based Marine attack squadrons earmarked for the 5th MEB.<sup>7</sup>

<sup>1</sup>Message JCS 6780 to CNO, CMC, CINCLANT, CINCPAC, 191726Z October 1962, TOP SECRET.

<sup>2</sup>Briefing for the CJCS, 0800 EDT October 25, 1962, TOP SECRET.

<sup>3</sup>Message JCS 6796 to CINCPAC, 192231Z, October 1962, TOP SECRET.

<sup>4</sup>Message JCS 6863 to CINCPAC, 221805Z, October 1962, TOP SECRET.

<sup>5</sup>Message CINCLANT to JCS, 222140Z, October 1962, TOP SECRET.

<sup>6</sup>Message JCS 6901 to CINCPAC, 231538Z, October 1962, SECRET.

<sup>7</sup>Message JCS 6899 to CINCPAC, 231510Z, October 1962, TOP SECRET

TOP SECRET

- 135 -

~~TOP SECRET~~

TOP SECRET

463. For some reason, the JCS on the 25th modified its order to CINCPAC of the 25th, instructing him to load the 5th MEB as soon as possible and to advise them of the earliest sailing date. Again he was enjoined not to sail the force until directed.<sup>1</sup> Finally the next day sailing orders were sent, and the force was chopped to CINCLANT.<sup>2</sup> The Brigade of [8500] men got under way at 271710Z in three increments; its estimated time of arrival at the Canal Zone was November 5th.<sup>3</sup> The Brigade was designated as CINCLANT reserve. It was called Landing Group East in OPLAN 316, and was to be ready to land at Guantanamo or wherever else CINCLANT determined.

464. In the meantime Marine forces in the Atlantic were mustering. As of early on the 23rd, [one] BLT afloat was moving to take up position [redacted] of the island; another BLT from [redacted] was to take up position [redacted] of Guantanamo; a third BLT was proceeding from Norfolk to take up position [redacted]. However, apparently [there] was a change in plans, and it was decided to keep the three BLT's with their amphibious life in an assembly area [redacted] in the Bahamas, where they would be held in readiness for OPLAN 316.<sup>5</sup>

465. As of the next morning, the [three] BLT's off Eleuthera were designated the 4th MEB, with [three] more BLT's of the 2nd Marine Division outloading from Moorehead City. By

<sup>1</sup>Message JCS 6544 to CINCPAC, 241822Z, October 1962, TOP SECRET.

<sup>2</sup>Message JCS 6579 to CINCPAC, 251055Z, October 1962, TOP SECRET.

<sup>3</sup>Briefing for the CJCS, 2100 EDT, October 27, 1962, TOP SECRET. This force is listed as 10,500 in the CJCS Briefing of November 1.

<sup>4</sup>JCS Cuba SITREP 1-62, 230400Z, October 1962, TOP SECRET.

<sup>5</sup>Briefing to the CJCS, 0200 EDT, October 25, 1962, TOP SECRET.

<sup>6</sup>Briefing to the CJCS, 0800 EDT, October 26, 1962, TOP SECRET.

TOP SECRET

TOP SECRET

~~TOP SECRET~~

arly on the 29th, all but one of the 2nd Divisions BLT's  
are afloat, and the last was due to sail that day.  
Excluding the 5th MEB, the [16,993] Marines of Landing Group  
West were either near or en route to Cuban waters. In  
addition, support units of the 2nd Marine Division and of  
the II Marine Expeditionary Force were being readied. In-  
cluding combat aviation, artillery and tank units, some  
[44,117] Marines were preparing.

Army Deployments

466. Probably the major set of problems facing the Army  
arose out of efforts to improve on movement schedules so as  
to reduce the time of getting Army forces ashore in Cuba.  
While the [redacted] interval between the opening of OPLAN  
312 attacks and the joint air/sea assault remained inflex-  
ible, some improvement was seen possible in reduction of  
closure rates for follow-up forces. The persistent pattern  
of query from the Secretary of Defense and/or the White  
House concerning the weight and speed of the assault,  
which shows up in the message files, clearly indicates the  
source of the pressure for such reductions.

467. The operational problems derived therefrom were  
essentially logistical, the same familiar tale of inadequate  
facilities and shipping.

468. With the changes in OPLAN's 314/316 which occurred up  
through the crisis itself, the Army's participation therein  
varied accordingly. By identifying the major Army units in  
the troop list as it appeared in mid-crisis week, it  
will be simpler to follow the various Army efforts.

<sup>1</sup>Briefing to the CJCS, 0800 EDT, October 29, 1962, TOP SECRET.

TOP SECRET

- 167 -

~~TOP SECRET~~

469.

a.

b.

c.

d.

470. The total Army force planned for commitment at the outset of the crisis was therefore [99,200.]

471. The air echelon would deploy directly from its home bases at Forts Bragg, Campbell, and Benning. It would stage from parts of embarkation at the Florida air bases.

472. [The surface echelon would deploy from home stations except for Task Force CHARLIE and one tank battalion which would deploy from Camp Stewart. The floating reserve would]

Deploy from Stewart and Benning, as would most of the on-call reserve. All these units would embark from East or Gulf coast ports.]

473. These then were the forces which the Army began to marshal.

474. All ZI armies had opened emergency operations centers by the 22nd and all units earmarked for OPLAN 316 were ordered to return to their home stations.<sup>2</sup> As it happened, a number of these units were engaged in exercises when the crisis began. CINCSTRIKE reported to the CJCS on the 20th that Exercise THREE PAIRS had been underway at Fort Hood, Texas, since October 15th, involving the 1st and 2nd Armored Divisions, key elements in OPLAN 316. He had approved withdrawal of tactical air units involved in the exercise and their return to home base, with only a minimum number of sorties arranged for exercise purposes. Several other units not based at Fort Hood were released to CINCSTRIKE for return to home station. CINCSTRIKE was reluctant to cancel the exercise, feeling its continuation would contribute to a higher state of readiness. Furthermore, he was concerned over the possible impact of cancellation on tactical surprise for OPLAN 316.<sup>3</sup>

475. The JCS requested CINCSTRIKE to release from THREE PAIRS all those Army and Air Force units required in OPLANs 312 and 316, specifically including any Air Force units not yet released and all Army units other than the 2nd Armored Division and whatever elements of the 1st Armored Division

<sup>1</sup>"The U.S. Army in the Cuban Crisis," op. cit.

<sup>2</sup>Message CINCLANT to AIG930, 221932Z, October 1962, TOP SECRET.

<sup>3</sup>Message CINCSTRIKE to CJCS, 201555Z, October 1962, TOP SECRET.

were not included in Cuban plans. The exercise was to continue on a reduced basis until October 27 to provide cover<sup>1</sup> for Cuban deployments.

476. CINCPAC was conducting Exercise SHORE LINE at this same time, and he received similar orders concerning<sup>2</sup> [312/316] units participating in it.

477. [The major Army deployment of a combat unit involved Task Force CHARLIE. This was the composite armored combat command designed to support OPLANS 314/316, totaling 4600 men from the 1st Armored Division. [REDACTED]

Increment [REDACTED]

478. [The JCS directed the loading for movement of Task Force CHARLIE (TFC) by rail from Fort Hood on the 22nd, with destination to be designated later.<sup>4</sup> Department of the Army's instruction to the CG USCONARC indicated TFC would go either to Fort Stewart or to a Gulf port.<sup>5</sup>]

<sup>1</sup>Message JCS 6814 to CINCSTRIKEZ, 210154Z, October 1962, TOP SECRET.

<sup>2</sup>Message JCS 6845 to CINCPAC, 220351Z, October 1962, TOP SECRET.

<sup>3</sup>"The U.S. Army in the Cuban Crisis," op. cit.

<sup>4</sup>Message JCS 6869 to CSA, 221833Z, October 1962, TOP SECRET.

<sup>5</sup>Message DA to CG USCONARC, 222302Z, October 1962, TOP SECRET.



479. The concern about getting TFC to a forward base lay in the fact that as late as the 24th, OPLAN 316 did not contemplate the introduction of American armor into the beachheads until [D+3]. In view of the build-up of Cuban capabilities, especially their acquisition of a sizable force of heavy Soviet tanks, this aspect of the OPLANS seemed to be extremely risky. The Chief of Staff of the Army took a personal hand in attempting to improve this situation, insisting that some U.S. armor go ashore on [D-Day]. By moving TFC forward to Fort Stewart, its arrival in the [redacted] beachhead could be significantly speeded up, provided LST's were at the ports of embarkation on time and other transportation arrangements were properly made.

480. [A change of plans on the 24th called for Increment 1 with its 22 M41 tanks to go ashore on D-Day; the next four increments by D+2; the last increment D+5. This meant 75 of TFC's tanks would be ashore by D+2. The new movement schedule was ready by the 26th and called for TFC's introduction being speeded by one to three days. At the same time the 2/69 Medium Tank Battalion which was to support the Marines at Tarara would also be speeded up, and a portion of the unit's 67 M48 tanks would go ashore on D-Day. This battalion had been ordered from Benning to Stewart on the 24th.]

481. The forward move of TFC was plagued by a number of mishaps and shortages of facilities. The first increment reached Stewart on the 26th but the whole force did not get there until after the first phase of the crisis had

---

<sup>1</sup>"The U.S. Army in the Cuban Crisis," op. cit.

TOP SECRET

~~TOP SECRET~~

ended. The 3rd and 4th increments were scheduled originally to go to New Orleans, but on the 27th it was proposed they move to Fort Lauderdale, Florida, reducing their movement time to the objective area by 3 days.<sup>1</sup> This was later cancelled.

482. The floating reserve was alerted for movement to Fort Stewart and commenced on the 28th. The on-call reserve forces were alerted for rail loading commencing November 2 for Fort Stewart.<sup>2</sup>

483. [Another set of problems in the Army deployments concerned the shortage of forward bases. The saturation of bases in southern Florida was recognized as a potential source of trouble, and CINCLANT began early to look for additional bases. He reported to the JCS on the 18th that after a conference with CINCAFANT and the CG XVIII Airborne Corps, he was convinced of the requirement for Opalocka Airfield, a World War II installation which had been turned over after the war to Dade County. The use of Opalocka, CINCLANT explained, was essential to the execution of OPLAN 316 because of the shifting of the planned use of southern Florida airbases from Army staging bases to the Air Force in order to accommodate the recently expanded requirements of OPLAN 312. Opalocka could be used to stage two Army battle groups for the airborne assault plus supply storage and as a hospital base.]

484. [He stressed that the base was urgently needed to assure completion of OPLAN 315 preceded by OPLAN 312. No other base existed.<sup>3</sup> However, two days later nothing had]

<sup>1</sup>Briefing to CJCS, 0800 EDT, October 27, 1962, TOP SECRET.

<sup>2</sup>Briefing to CJCS, 0600 EDT, October 26, 1962, TOP SECRET.

<sup>3</sup>Message CINCLANT to JCS, 151348Z, October 1962, TOP SECRET.

TOP SECRET

172

~~TOP SECRET~~

[apparently yet been done by the JCS, and so CINCLANT queried the JCS as to whether he had their authority to negotiate with Dade County officials for the immediate use of the base. He urged immediate granting of authority so negotiations could begin early on the 22nd, and further asked authority to use a cover story.]

485. [Presumably the authority was granted, since by the afternoon of the 22nd CINCLANT reported that negotiations had been successfully completed with the county officials, authorizing immediate use of Opalooka, and that CINCLANT was already starting to preposition materiel and equipment.<sup>2</sup> The JCS thereupon immediately authorized the movement of units, at CINCLANT's discretion, into Opalooka.]

486. Similar efforts were launched by CINCLANT on the 21st to get the use of the Key West International Airport, but no results had been achieved before the first phase ended.

487. Shipping problems were crucial in the preparations for the execution of an assault on Cuba, but they must be dealt with only cursorily in this study. The problem was the standard one of time and an inadequate number of the proper type of ships. The change in planning focus with the dropping of OPLAN 314 and its [eighteen-day] reaction time and the substitution of a [seven-day] reaction time meant that all shipping schedules designed to support the [314] plan had to be rescheduled to cover the [507 1-JC] plan. Early on the 22nd CINCLANT requested that all planning

<sup>1</sup>Message CINCLANT to JCS, 201/282, October 1962, TOP SECRET.

<sup>2</sup>Message CINCLANT to JCS, 221/383, October 1962, TOP SECRET.

<sup>3</sup>Message JCS to CINCLANT, 221743Z, October 1962, TOP SECRET.

TOP SECRET

~~TOP SECRET~~

Action possible be taken immediately to enable MSTTS shipping to be placed in berth in the time required to meet the fast reaction time of [OPLAN 316] and all MSTTS ships in Atlantic coast harbors were held for possible [316] use.

488. There was a feverish search for amphibious vessels which were in particularly short supply to carry the Army forces. CINCARIB, faced with possible multiple calls for help from Latin American governments, had his [two] LST's taken from him and given to CINCLANT.<sup>1</sup> Even commercially owned LST's in the Gulf area were considered for chartering. However, most of the activity over shipping came after the first phase when the rather ponderous machine of the assault force began to achieve some readiness status.

489. With the additional requirements for airlift imposed by the reinforcement of the Army air-landed echelon under the revised [OPLAN 316], consideration was given early to the possible call-up of reserve units, especially troop carrier ones. As a result of a verbal directive from the JCS, CINCLANT on the 19th advised his subordinate commanders that they might plan for the mobilization of reserve units, including those employing troop carrier aircraft on D-Day but not before.<sup>2</sup> The JCS corrected the impression given by CINCLANT's message by further notifying him that as of that time mobilization was approved on D-Day only for reserve units employing troop carrier aircraft.<sup>3</sup>

<sup>1</sup>Message JCS 0707 to CINCARIB, 192037Z, October 1962, TOP SECRET.

<sup>2</sup>Message CINCLANT to JCS, 190632Z, October 1962, TOP SECRET.

<sup>3</sup>Message JCS 6784 to CINCLANT, 192018Z, October 1962, TOP SECRET.

TOP SECRET

- 174 -

~~TOP SECRET~~

490. Presumably this restriction to D-Day was part of the security apparatus surrounding Cuban operations, but at all events the decision was made not to wait for D-Day. As of 0900 (local) October 28th, the Air Force directed the call-up of certain reserves, consisting of [eight] troop carrier wings. These totaled:

- [21 squadrons of C-119 at 16 aircraft per squadron - 336
- 3 squadrons of C-123 at 16 aircraft per squadron - 48
- 6 aerial port squadrons.]

491. It was estimated that [315] C-119 sorties would be required for heavy drop in the parachute assault of D-Day and [53] C-119 sorties for the air-landed elements on D-Day and D-1. [Thirty-five]<sub>1</sub> C-123 sorties were scheduled for air landing on D-Day. The additional [382] aircraft thus would make an invaluable augmentation to follow up airlift operations.

492. In total, then, the forces preparing to assault Cuba at the close of the first phase numbered some [259,000] men. These included the Army and Marine forces described, and a Navy force comprising a striking and covering group with [two] attack carriers, an ASW group, and a submarine group. The rounded manpower totals were:

Total Navy personnel afloat -	65,000
Total Army personnel afloat -	
Total Marines (including Guantanamo) -	
Total Air Force personnel -	
	100,000
	44,000
	50,000. <sup>2</sup>

C. INTERESTING GENERAL AIR PREPARATIONS

493. Concurrent with the deployments just described, which were intended solely to deal with the Cuban contingency,

<sup>1</sup>Briefing to the CJCS, OCSO EDT: October 20, 1962, TOP SECRET.

<sup>2</sup>Briefings to the CJCS, October 28-30, 1962, TOP SECRET.

TOP SECRET

~~TOP SECRET~~

U.S. general war forces were readied and marshalled, as part of the overall deterrent posture the U.S. was attempting to present to the Soviet Union. Both offensive and defensive forces deployed with admirable efficiency and no major problems were encountered in either category.

Offensive Preparations

494. General war offensive forces deployed or brought to readiness included SAC, naval strategic forces, and tactical air units assigned to general war missions in the overseas commands. The records available did not provide any data on the readiness process for naval forces, so it must be presumed they reached proper alert status at the assigned times.

495.



495. The next day CINCSAC was directed to initiate the 1/8 airborne alert, beginning immediately and to be in full effect by Tuesday, October 23. The JCS stated that

Message JCS 5332 to CINCSAC, 211925Z, October 1962, TOP SECRET.  
JCS Cuban SITREP 2-62, 240400Z, October 1962, TOP SECRET

TOP SECRET

- 175 -

~~TOP SECRET~~

in Europe.

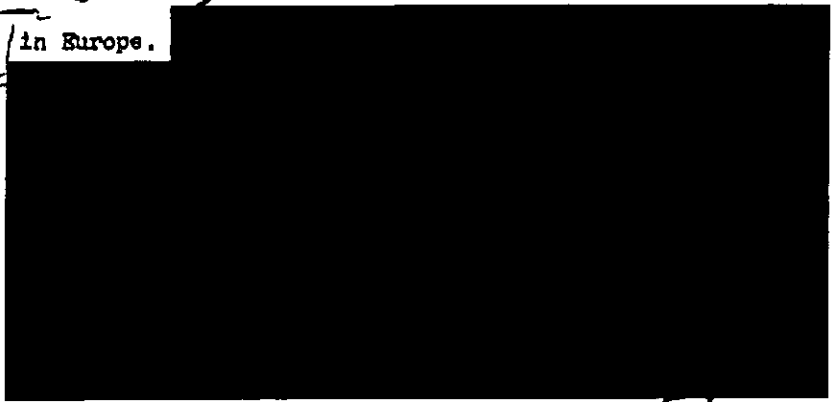

Defensive Preparations

504. Defensive preparations for general war were taken both by air and sea forces in this period. Concurrent with the measures taken to reinforce the southeastern portion of the U.S. were CINCONAD measures to raise the alert level of all national air defenses.

505. As a precaution, the JCS authorized CINCONAD on the evening of the 21st [redacted] until such time as the dispersal of the interceptor force was ordered within CONUS.<sup>2</sup> The dispersal order itself came the following afternoon, the move to be carried out on a very quiet, low key basis.<sup>3</sup> The dispersal of the NORAD fighter force was completed during the 23rd, [173] aircraft moving to their dispersal sites.<sup>4</sup>

01.41

506. Deployment of all fighter-interceptors was completed during the 24th, and by 0800 on the 25th the full force was in position. [One-hundred and fifty-four airplanes]

<sup>1</sup>Message JCS 7035 to CINCEURH, 271120Z, October 1962, TOP SECRET.  
<sup>2</sup>Message JCS 6834 to CINCONAD, 211940Z, October 1962, TOP SECRET.  
<sup>3</sup>Message JCS 6858 to CINCONAD, 221630Z, October 1962, TOP SECRET.  
<sup>4</sup>JCS Cuba SITREP 2-62, 240400Z, October 1962, TOP SECRET.

TOP SECRET

[were on a five-minute ground alert, 444 were on a fifteen-minute alert, and 446 were on a one- to three-hour alert.]<sup>1</sup>

507. Air defense capabilities remained high, CINCONAD reporting at 2000 on 26 October that 94 percent of his fighter forces, 92 percent of the SAMs and 99 percent of surveillance equipment were operationally ready.<sup>2</sup> Before this time, however there had been a slight decrease in the pressure on CINCONAD's forces nationwide. This was probably the result of the generally sound state of air defenses. In a summary to the CSAF early on the 23rd, CINCONAD stated that the former air defense capability had been only slightly disturbed by the deployments to the southeast, and that, in the light of the present situation, the overall air defense capability had been substantially increased.<sup>3</sup>

503. The airborne alert manning level was reduced from [ten] interceptors [to four] effective 1145 on 23 October, the new level to be maintained but increased immediately if needed. Additional interceptors would be maintained on strip alert available for immediate scramble and augmentation of the airborne alert force. The reduced level would allow for continuous operations and would conserve the interceptor force for any higher alert level required.<sup>4</sup>

505. The extent and complexity of operational air deployments connected with CONUS defense and SIOP readiness preparations, and the concomitant need for central coordination of the respective activities of the two co-equal CINCs involved,

<sup>1</sup>Briefing for CJCS, 0800 EDT October 25, 1962, TOP SECRET.

<sup>2</sup>JCS Cuba SITREP, 270400Z, October 1962, TOP SECRET.

<sup>3</sup>Message CINCONAD to CSAF, 230250Z, October 1962, TOP SECRET.

<sup>4</sup>JCS Cuba SITREP 2-62, 240400Z 1962, TOP SECRET.

TOP SECRET



TOP SECRET

~~TOP SECRET~~

prompted the JCS on 24 October to name the Chief of Staff, USAF, as their executive to direct SAC and CONAD in carrying out crisis-related responsibilities.<sup>1</sup>

510. A naval defensive measure was taken with the establishment of an antisubmarine barrier, to be placed initially in the vicinity of Argentia, Newfoundland, as directed by CINCLANTFLT on the 25th. The barrier was to be composed of patrol aircraft and submarines, and should the situation worsen, the barrier would be moved outward to the Greenland-Iceland-United Kingdom line.<sup>2</sup> SUBRON 8 moved out of New London at 1400 on 27 October, comprising [ten] submarines, which were to take up positions on the Argentia Barrier. All were expected to be in place by 2000 on 30 October.<sup>3</sup>

#### D. SUMMARY OBSERVATIONS

511. From the events and major command problems described, certain inferences may be drawn concerning underlying command and policy dilemmas. These are not the sorts of issues which appeared specifically in the flow of messages and directives, but rather appeared indirectly at intervals as certain problems arose. Nevertheless, the influence of these dilemmas was pervasive and quite evident in the nature of the major operational problems and in the way the JCS dealt with these.

512. The really crucial and interesting lessons derived from U.S. military deployments all came between October 20 and 28. These were the deployments made under the pressure of time, secrecy, and the need to act without provoking what we wished to avoid. Deployments continued up until the quarantine was lifted on November 21, since the Soviet

<sup>1</sup>Hq USAF Chronology of the Cuban Crisis, TOP SECRET. (Also referred to in Secretary of the Air Force, Office of Information, Chronology of the Cuban Crisis, TOP SECRET.) No record of the CS/USAF being so designated has been found in JCS files or other sources available to this study. Presumably such action was taken informally in the course of a JCS meeting on the 24th and the only instructions were relayed orally at the time.

<sup>2</sup>JCS Cuba SITREP 4-62, 280400Z, October 1962, TOP SECRET.

<sup>3</sup>JCS Cuba SITREP 6-62, 280400Z, October 1962, TOP SECRET.

TOP SECRET

~~TOP SECRET~~

TOP SECRET

~~TOP SECRET~~

promise to remove the missiles had to be carried out, the negotiations for removal of the JIL 28's conducted, and this promise carried out. However, these latter deployments suffered little of the pressures of the first week. The entire psychological atmosphere was changed by the Soviet concession on Sunday the 28th.

513. The relative smoothness demonstrated in some of the deployments was due in no small measure to the fact that U.S. forces had warning. While the CINC's were not officially informed by the JCS of the nature of the U.S. action program until the 21st of October, we have seen how the CONUS-based CINC's, LANT, SAC, CONAD, were all engaged in preparations by the 17th, the day after the President had seen the incriminating photographic evidence. Their subordinate commanders and the overseas CINC's were also very soon the recipients of information copies of messages or Service directives which alerted them to coming action. This interval permitted, despite rigid secrecy restrictions, many preparatory moves at the command and staff levels.

514. For example, [CINCSAC on the 17th directed his staff and subordinate commanders to prepare to execute the 1/8 airborne alert and the dispersal of the B-47 force, and yet the moves were not ordered by the JCS until the 22nd.] Similarly, no air threat against the southeastern U.S. was likely until after the President's address on the evening of the 22nd, but CINCONAD had been directed to take action to augment the area's defenses on the 17th. AFLANT's deployments began at noon on the 21st, but were preceded by three days' preparation time.

TOP SECRET

- 182 -

~~TOP SECRET~~

TOP SECRET

~~TOP SECRET~~

515. In these cases strategic warning was put to excellent use. However, the nature of the forces, their mobility and speed of response, allowed them to exploit the advantages of strategic warning. In the case of the assault forces, the other side of the strategic warning coin was shown. It is very often forgotten that the simple receipt of strategic warning itself is not enough to confer an advantage; one must be able to use it when one gets it. In other crisis situations of recent years the U.S. has sometimes received such warning, but has often been unable to act militarily because of political considerations. It has been necessary not to alarm friends, not to provoke enemies, to preserve secrecy. The second and third of these considerations were very evident in the Cuban crisis.

516. The dilemma of the Cuban crisis was that the very forces which had greatest need of the maximum strategic warning in order to prepare and to deploy, the assault forces, were the very ones which could least exploit what warning they did receive. [ Under the need to maintain secrecy until the U.S. program was sprung as a surprise on the Russians on the 22nd, deployments by the ponderous assault forces using public railroads, highways, and ports were obviously infeasible. Thus strategic warning clashed with the political need for secrecy. This was crucially important because of the need of the assault forces to reduce to the minimum the time span between the opening of OPLAN 312 and the closure of all assault forces on Cuba. ]

517. There was also evidently operative the other contradictory aspect mentioned above, political constraints. The U.S. policy was to ensure that the Soviets were fully aware of our intention and our ability to remove the

TOP SECRET

- 183 -

~~TOP SECRET~~

TOP SECRET

~~TOP SECRET~~

offensive weapons, even if it meant invading Cuba to do so. On the other hand, we also wanted them to understand that we would do this only as a last resort in pursuit of the stated objective. We were threatening invasion and preparing for it clearly, but we did not wish to create the impression that a U.S. invasion was utterly inevitable, since this was the extreme measure of violence as far as Cuba was concerned. Invasion implied the destruction of the Castro regime, and thus raised an entirely different set of problems for the Russians.

518. Even if the secrecy requirements of the week before the 22nd had not tended to preclude it, any major assault forces deployments in that period may very well have been held up in order not to create an impression of inevitability as to employment, and thus tend to paint the Soviets into a corner. In other words, the critical political consideration of leaving the Soviets a way to escape a clash by simply removing the offensive weapons and thus make unnecessary a U.S. invasion of Cuba may well have strongly influenced the assault forces deployments.

519. [Another problem area for command which emerged in the crisis concerned the clash of requirements for contingency operations against Cuba and the preparations for general war. Despite the overall potential in the situation, the crisis involved basically the likelihood of a limited war in Cuba [redacted] At the same time the consequences of invasion were incalculable and preparations for possible all-out war indispensable. The problem of choice arose several times during the deployments between the requirements of the more likely but less ]

TOP SECRET

- 184 -

~~TOP SECRET~~

horrendous and the less likely but more horrendous. ]

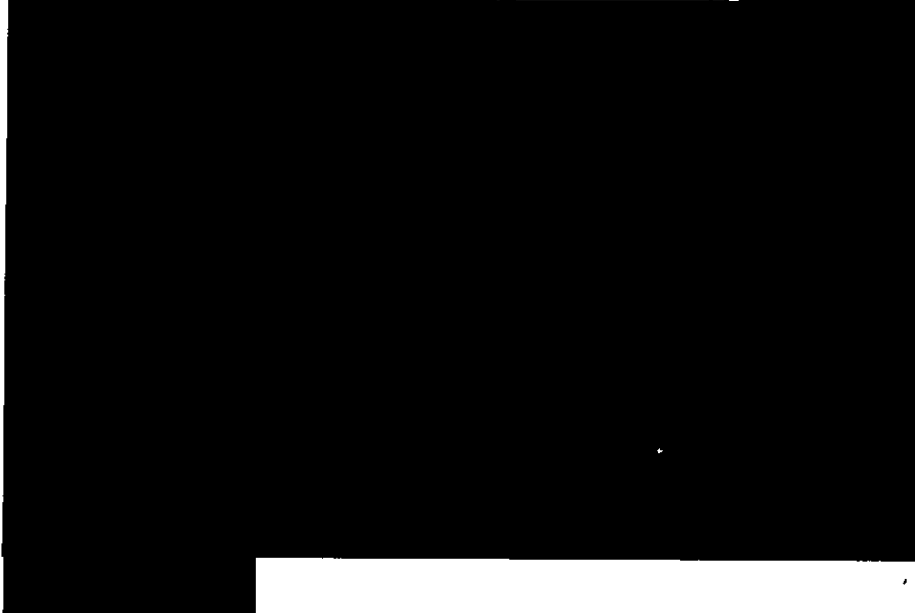

520. [In short, the dilemma posed was that of requirements for the best defense in a contingency versus the desire to apply the minimum measured degree of force in order to prevent escalation.]

521. Another aspect of this same general problem concerned the possible Cuban use of nuclear weapons against a U.S. assault force. The President's statement of October 22nd made clear how we would view any nuclear missile launched from Cuba against the U.S. or any other country in the hemisphere, but the Cuban use of such weapons in defense of their island was something else.]

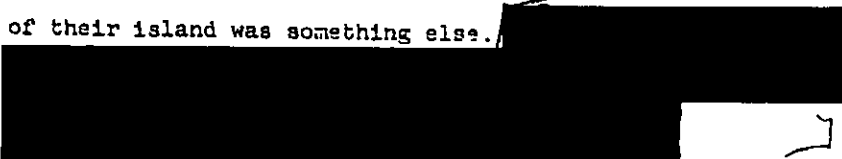

<sup>1</sup>The nature of the discussion of this problem which ensued is described in Chapter VII of this study, "Adjusting Contingency Plans to Crisis Requirements."

4 [REDACTED]

BIAI.

522. [REDACTED]

The attitudes displayed by the JCS in their command actions in the first week clearly evinced these uncertainties. The clear academic distinctions between the aforementioned sets of categories were seen to be not so clear after all. The ambiguity arose from the fact of the Soviet presence. That presence created a situation which the contingency plans for Cuba no longer fitted.)

in

523. The result was a deliberate effort on the part of the JCS, presumably mirroring the concern of higher political authorities, to maintain a very tight control. In some cases this was done by carefully spelling out directives, such as in the Blockade of Cuba Order. In other cases it was deemed best not to be explicit, but rather to maintain control through flexibility. This sometimes, in fact almost inevitably, concurrently produced ambiguity, as in the rules of engagement instructions to CINCONAD for the southeast U.S. or the instructions to the Base Commander at Guantanamo. Presumably by not spelling out limitations of authority, the JCS would de facto compel responsible commanders to check back with them before making any serious move. Hence, ~~de facto~~, control tended to be strengthened through ambiguity.

## VI. THE NAVAL QUARANTINE

524. Of the four principal aspects to the U.S. military response to the 1962 Cuban crisis, the one that was pivotal was the actual imposition of a naval quarantine. Since preparations for more drastic military measures are analyzed in other sections of this study, this Chapter will focus solely on the naval quarantine. The purpose will be to examine the quarantine operations retrospectively, in order to determine the nature of the problems encountered at the higher levels of military decision making as they affected and were dealt with by the JCS.

525. Throughout the crisis the different aspects of the U.S. military response required many decisions and actions which necessarily took into account the reciprocal impact of any one aspect on the others. Discussion of these interrelationships insofar as they affected command and control, however, can best be accomplished elsewhere in this analysis and therefore will not be included here. (See Ch. V and VII.)

526. Similarly, in addition to being influenced by purely military considerations, day-by-day decisions concerning the conduct of quarantine operations also were directly responsive to concurrent developments in the international political arena. Available data permit only a sketchy examination of the interface between the quarantine operation itself and these political developments. Despite the limitations, an attempt will nevertheless be made tentatively to relate these two phenomena. It is essential to bear in mind that the findings of this portion of the analysis are conditional. Information not presently available might qualify or cast additional light on the interplay between international political developments and military decisions relating to the quarantine as this interplay evolved during the crisis.

A. PLANNING AND ORGANIZING FOR THE QUARANTINE

527. Operation plans for a military blockade of Cuba had existed prior to the 1962 crisis. However, these had been predicated upon a total air and sea blockade of the island in the context of a confrontation with the Castro regime.<sup>1</sup> Although these plans anticipated the possibility of USSR support of Castro, they were not intended for a contingency in which the major parties to the conflict were the U.S. and the Soviet Union.

528. Plans for the far more limited quarantine which actually was carried out were ad hoc and emerged after the crisis began. They were developed during the critical week of national decision making which followed the initial receipt, on 14 October, of the photographic evidence that the Soviets were in the process of establishing IRBM, MRBM, and IL-28 bases in Cuba.

529. The decision to maintain tight security until more reconnaissance photographs could be obtained and evaluated -- and an appropriate course of action decided upon by the President -- drastically limited the number of persons informed about the new developments prior to 19 October.

530. Various alternative courses of action were discussed earlier by the small group of high-ranking officials which the President quickly had organized into an Executive Committee of the National Security Council to serve as his principal advisors. This Executive Committee, whose sole military member was the Chairman of the Joint Chiefs of Staff (the Secretary of Defense and the Deputy Secretary of Defense also served on the committee), relied, in turn, on a small, select group of policy planners for assistance.

<sup>1</sup>Further details may be found in Chapter II of this Enclosure, "Pre-Crisis Military Contingency Planning."



TOP SECRET

531. From 17 October onward<sup>1</sup> in the NSC Executive Committee and its subsidiary advisory groups, thinking focused increasingly on a limited naval blockade of Cuba as a first step in the U.S. response. However, although the President himself seemed to be moving towards a decision to impose a limited blockade, he had not ruled out entirely other possible courses of action.

532. On 19 October, before leaving Washington to keep previously scheduled and widely publicized speaking engagements which could not be cancelled without compromising secrecy, the President met with the Joint Chiefs of Staff, the Secretary of Defense, and the Secretary of State.<sup>1</sup> Although what transpired at this meeting has not been disclosed, preparations for implementing a limited naval blockade, if so directed, increased significantly immediately thereafter within the Office of the Chief of Naval Operations (CNO) and, to a lesser extent, within the JCS organization.

533. The exact time and circumstances under which the CNO was designated to act as the representative of the JCS on matters pertaining to the blockade and the defense of Guantanamo are ambiguous. The arrangement seems to have evolved de facto, gradually emerging over a period of several days prior to 21 October.<sup>2</sup>

<sup>1</sup> Anonymous, "Chronology of the Cuban Crisis: October 15-28, 1962," UNCLASSIFIED. This chronology utilizes information furnished by the Press Officers of the White House, the Department of Defense, and the State Department. Presumably, it was prepared in the Office of the Assistant Secretary of Defense for Public Affairs.

<sup>2</sup> The first two explicit documentary references to the role of the CNO as the agent of the JCS on blockade matters uncovered during this study were dated 20 and 21 October, respectively. On 20 October, in reply to the questions posed by the Deputy Secretary of Defense the previous day, the JCS reminded the Deputy Secretary that "...the whole blockade program has been assigned to Admiral Anderson (CNO) by the Secretary of Defense." (JCS)-790-62 20 October 1962, TOP SECRET.) Since this was the case, the memorandum continued, the JCS had refrained from replying to those of the Deputy Secretary's questions which related to rules of engagement, concept of operations, etc., for a potential blockade. (Ibid.) In another memorandum dated 21 October, the CNO's executive officer referred to the designation of the CNO as JCS 'representative' for the naval blockade and the defense of Guantanamo and outlined procedures designed to ensure coordination between various officials and agencies, including the JCS, which were involved in policy decisions concerning the blockade. (OP-00 Memo 00092/62, from Exec/CNO to distribution, TOP SECRET.) Staff officers within J-3 who were assigned duties relating to the blockade were not informed of the circumstances under which the CNO was designated to serve as the JCS representative. (Interviews with J-3 personnel.)

TOP SECRET

534. The day of the White House meeting in which the Joint Chiefs of Staff participated (19 October), the Secretary of Defense apparently requested that the CNO develop rules of engagement and detailed operational concepts for a limited naval blockade.<sup>1</sup> Presumably, policy guidelines for the blockade concept were coordinated by OPNAV through the Deputy Secretary of Defense with the work on legal aspects of a blockade which had been under way within the Departments of Justice and State since the previous evening (18 October).<sup>2</sup> About the same time, the Deputy Secretary of Defense requested the views of the JCS on several matters relating to a potential blockade of Cuba, including rules of engagement, the materiel to be included in the list of prohibited items, and the capabilities of Latin American nations to assist in execution of the plan.<sup>3</sup>

535. The following day (20 October), the JCS transmitted its opinions on some of the questions raised by the Deputy Secretary of Defense. For example, an estimate of the probable availability of Latin American naval resources for participation in a blockade was furnished. However, the Joint Chiefs of Staff refrained, at this time, from commenting formally on either the rules of engagement or detailed operational concepts for the blockade. Under the procedural arrangements which were evolving, the primary planning responsibilities in this area already had been delegated to the CNO by the Secretary of Defense. Proposed rules of engagement, operational concepts, and other planning papers related to the blockade had been drafted during the night of the 19th within OPNAV. These apparently were scrutinized by the Joint Chiefs of Staff on the morning of 20 October.<sup>4</sup>

<sup>1</sup>JCSM-799-62, 20 October 1962, TOP SECRET.

<sup>2</sup>CNO Flag Plot Cuban Watch Log, 19 October 1962, *passim*, TOP SECRET; New York Times, 6 November 1962, UNCLASSIFIED.

<sup>3</sup>JCS 2304/74, 20 October 1962, pp. 530-537, inclusive, TOP SECRET, RESTRICTED DATA.

<sup>4</sup>*Ibid.*; JCSM-799-62, *op. cit.*

TOP SECRET

~~TOP SECRET~~

536. Meanwhile, within the JCS organization, and particularly within J-3, substantive and procedural preparations relating to the potential imposition of a limited naval blockade also had been accelerated.

537. At the request of the Chairman, JCS, on 19 October the Director, J-3, had established a special blockade group composed of three officers. This group, headed by Captain D. L. Moody, USN, was assigned primary responsibility for:

- a. Maintaining liaison with the office of the CNO;
- b. Coordinating with the Director and Deputy Directors of J-3 on blockade matters, and
- c. Insuring that the flow of information on blockade developments to the Office of the Chairman, to the JCS, and to the Director, Joint Staff was both adequate and timely.<sup>1</sup>

Because of the special security measures still being maintained and the heavy workload of all J-3 personnel assigned to Cuba-connected activities, there was, at this time, no formal coordination between the blockade group and either Current Actions Center watch personnel or those designated to become members of the Joint D Title Staff teams who were beginning to be alerted.<sup>2</sup>

538. Within the CNO Flag Plot, a special Cuba watch team also was activated on 19 October, at 1500 EDT. The CNO Flag Plot watch was instructed that when policy decisions were required on matters pertaining to the planning for the potential naval blockade of Cuba or the defense of Guantanamo, these were to be referred to the CNO, the Vice-CNO, the Deputy CNO for Plans and Policy, or the Deputy CNO for Fleet Operations and Readiness.<sup>3</sup> These flag officers formed the nucleus of a Policy Watch which was on duty around-the-clock throughout the crisis.

<sup>1</sup>Memorandum for General Taylor from Major General Unger, 20 October 1962, SECRET; Memorandum for Director, J-3, et al; from Military Secretary, J-3, "Quarantine Operations," 25 October 1962, SECRET; interviews with J-3 personnel.

<sup>2</sup>Ibid.

<sup>3</sup>CNO Flag Plot Log, *passim*; TOP SECRET; OP-00 Memorandum 00092/62, 21 October 1962, TOP SECRET. Further details on the role of CNO Flag Plot during the crisis may be found in Appendix B to Enclosure D of this analysis.

TOP SECRET

- 191 -

~~TOP SECRET~~

539. By 1430 EDT, on 20 October, the President was back in Washington, having cancelled the remainder of his campaign trip. A cover story for the press had claimed he was ill with a cold. The NSC Executive Committee, augmented, was in session at the White House. During this session, the President decided to institute the limited naval blockade of Cuba -- which he later termed a "quarantine" -- as quickly as possible, taking account of the necessity to notify Allies and to permit completion of the military preparations. The time for a public announcement by the President of the United States' intentions was tentatively set for 1900 EDT, on Monday 22 October.<sup>1</sup>

540. Meanwhile, the special J-3 blockade group had been in frequent contact with CNO Flag Plot and other OPNAV Cuban action groups. Staff work related to planning for the quarantine again continued throughout the night. Within OPNAV, revised rules of engagement were drafted. The J-3 blockade group, assisted by other duty officers, prepared for the Director, J-3, a checklist of items requiring JCS consideration. Draft texts of messages were appended to this checklist. These draft messages were intended to furnish in advance the basis for the messages which would have to be transmitted as actions were approved and implemented.<sup>2</sup>

541. On Sunday, 21 October, the Joint Battle Staff was activated. Arrangements for representatives of the National Security Agency to be on duty in the Current Actions Center (CAC) on a 24-hour

<sup>1</sup>"Chronology of the Cuban Crisis...", op.cit., page 5.

<sup>2</sup>Ultimately, this checklist was termed the J-3 MCL. Because of other demands on the blockade group, responsibility for its preparation subsequently was reassigned. (Memorandum, "Responsibilities for Preparation of Daily Master Checklist for Cuban Operations," dated 23 October 1962, from Brigadier General E. H. Burba to other Deputy Directors, J-3, and to Chiefs, Operations Plans, General Operations and current Operations Divisions, J-3, SECRET.) For a detailed discussion of the development and preparation of the Master Checklist (MCL), see Enclosure B of this study, "Procedural Analysis of J-3 Command and Control Operations."

TOP SECRET

~~TOP SECRET~~

basis had been completed. Similar arrangements for the assignment of State Department staff members to duty in the CAC were in process. The Office of the CNO outlined in detail formal procedures for ensuring coordination between OPNAV and the JCS organization.<sup>1</sup> Ad hoc procedures had evolved for effecting inter-departmental decisions and coordination on policy papers pertaining to the blockade and other crisis matters. The White House, the Office of the Secretary of State, the Office of the Secretary of Defense, the Office of the Deputy Secretary of Defense, the Office of the Chairman of the Joint Chiefs of Staff, the Joint Chiefs of Staff, and the Office of the Chief of Naval Operations were utilizing a special courier service to accomplish whatever policy coordination was required during periods when the Executive Committee of the NSC and the Joint Chiefs of Staff were not in session.

B. ALERTING THE QUARANTINE FORCE

542. Presumably, CINCLANT had been kept informed of major developments in Washington throughout the critical week of national decision making. However, available data do not reflect in any detail what role, if any, CINCLANT played in the operational planning for the quarantine.

543. On the afternoon of 21 October, the CNO, in his capacity as JCS representative for quarantine operations and the defense of Guantanamo, directed to LANTCOM the first in a series of exclusive Cuba contingency SITREPS. Shortly thereafter, CINCLANT, in his capacity as CINCLANTFLT, directed COMSECONDFLT, in his capacity as blockade commander, to submit four-hour SITREPS if operations were initiated. The same message informed the blockade commander that

<sup>1</sup> Apparently, some of these procedures were not implemented immediately. Coordination between the Joint Battle Staff Teams and the CNO Flag Plot Watch continued to be somewhat sporadic until at least 24 October. Throughout the crisis, the special J-3 blockade group served as the principal J-3 liaison with OPNAV. (Memorandum: "Quarantine Operations," from Military Secretary, J-3 to: Director, J-3 Battle Staff Chief /gic/; Quarantine Watch; Operations Support, NMCC; EA Team, NMCC; dated 25 October 1962, SECRET.)

TOP SECRET

~~TOP SECRET~~

TOP SECRET

~~TOP SECRET~~

the probable first target at the quarantine line was the Soviet merchant ship POLTAVA, expected on 29 October.<sup>1</sup>

544. About the same time, an exclusive message personally drafted by the Chairman, JCS, was transmitted to all the CINCS and to LANTCOM component commanders. General Taylor's message reported that:

a. The President was considering the establishment of a blockade of Cuba;

b. DEFCON 3 would be established worldwide effective at the time a public announcement of U.S. intentions was made;

c. This announcement was tentatively scheduled for the evening of 22 October, D.C. time; and

d. The tentative time for initiation of blockade operations would be somewhere between 24 and 48 hours later.

Addressees were cautioned that this information was extremely sensitive and were directed to hold it closely.<sup>2</sup> The CINCS earlier had received hints, and even a formal warning, that military action against Cuba was under consideration. Reinforcements had begun to arrive at Guantanamo in phased tactical groups as early as 19 October. Two days previously, CINCONAD had been directed to augment the air defenses of the southeastern U.S. immediately. However, this message was the first from the JCS to alert the CINCS to the fact that the national decision makers were moving towards the imposition of a blockade as the initial military move.

545. Shortly after the Chairman's exclusive warning message concerning the blockade had been dispatched, the President again met in the White House with the National Security Council. The CNO participated in this meeting. Progress reports were given on

<sup>1</sup>CNO Message to CINCLANT and LANTCOM Component Commanders, Exclusive, DTG 211713Z October, TOP SECRET; CINCLANTFLT Message to COMSECONDFLT, DTG 211805Z October, TOP SECRET.

<sup>2</sup>JCS Message 6830, Exclusive, DTG 211841Z October, TOP SECRET.

TOP SECRET

- 194 -

~~TOP SECRET~~

preparations for the blockade, and the third draft of the President's speech was discussed. It was decided at this NSC session that, although the first U.S. objective would be to block further shipments of Soviet offensive military equipment to Cuba, it also was essential to insure that the Soviet missiles already in Cuba be removed under U.N. supervision and inspection.<sup>1</sup> At 2200 EDT the Secretary of Defense approved the concept of operations and the rules of engagement for the quarantine.<sup>2</sup>

546. The detailed policy guidance approved by the Secretary of Defense on the evening of 21 October was not formally transmitted to CINCLANT by the JCS until about seven o'clock the following morning, Washington time. Apparently, the final draft of the message containing this guidance had been prepared during the night, primarily within OPNAV. If its transmittal was prefaced by any earlier communications between the CNO, in his role as JCS representative for naval quarantine operations, and CINCLANT, this fact is not reflected in available data. Nor do these data show any evidence of communications, during the night between key deputies of the CNO and CINCLANT.<sup>3</sup>

547. Irrespective of the extent of communication between these echelons which took place after the Secretary of Defense had approved the concept of operations and the rules of engagement late in the evening of 21 October, approximately two hours earlier, at 2026 EDT, CINCLANT, acting in his capacity as CINCLANTFLT, had issued his initial OP order concerning a limited naval blockade of Cuba.<sup>4</sup> The OP order was effective for planning on receipt and for

<sup>1</sup>"Chronology of the Cuban Crisis...", op.cit., p. 6.

<sup>2</sup>Ibid.

<sup>3</sup>Neither the CNO Flag Plot Log entries covering this period nor the message traffic examined shows any evidence of communication between OPNAV and LANTCOM during the night at any time after 2200 EDT, the hour when the quarantine concept of operations and rules of engagement were approved by the Secretary of Defense. However, no complete record of secure voice link traffic was released to the authors of this study.

<sup>4</sup>CINCLANTFLT OP Order 45-62 to COMSECONDFLT, COMASWFORLANT, COMOPTEVFOR, and COMTRALANT, info to CINCLANT, CNO, JCS and CINCARIB. Transmitted as CINCLANTFLT message DTG 220026Z October, TOP SECRET.

TOP SECRET

~~TOP SECRET~~

execution when directed. It established a blockade force, designated as Task Force 136 (TF 136), under the command of COMSECONDFLT in the NEWPORT NEWS. COMSECONDFLT was directed to designate COMCRUDESFLT 6 in the CANBERRA as the surface quarantine group commander. The OP order also directed certain other CINCLANTFLT component commanders to "CHOP" (change operational control of) snips required for the blockade operations to COMSECONDFLT. COMASWFORLANT was directed to conduct air surveillance as requested by the blockade commander. Direct liaison was authorized among the various LANTFLT commands involved, with CINCLANTFLT to be kept informed. The commander of the blockade force was directed to submit contact reports with flash precedence and to make amplifying reports of significant interception/visit and search developments by OP immediate message, addressed for action to CINCLANTFLT, with info copies to CNO, CINCLANT, and JCS. The blockade commander was also directed to submit SITREP's every four hours to the same addressees. It was noted that "no-change" (i.e., negative) SITREP's also were required. The OP order also stated that Russian interpreters were to be provided by BuPers.<sup>1</sup>

C. CONCEPT OF OPERATIONS AND RULES OF ENGAGEMENT

548. The concept of operations and rules of engagement contained in the original CINCLANTFLT OP order to the blockade task force were essentially the same as those contained in the instructions subsequently transmitted to CINCLANT by the JCS. However, slightly less emphasis was placed on keeping the use of force to the absolute minimum. The original OP order did not allude to the possibility of the participation of the vessels of Allied or friendly nations in the blockade operation. The potential extension of the

<sup>1</sup>CINCLANTFLT OP Order 45-62 to COMSECONDFLT, COMASWFORLANT, COMOPTEVFOR, and CONTRALANT. Transmitted as CINCLANTFLT Message DTG 220026Z October, TOP SECRET.

TOP SECRET

- 196 -

~~TOP SECRET~~



TOP SECRET

~~TOP SECRET~~

blockade to include measures to prevent the importation of prohibited materiel into Cuba by airlift, as well as by sealift, was not mentioned. COMSECONDFLT, as commander of TF 136, was authorized to make such tactical decisions as designating the ships to be intercepted, naming the U.S. ports to which uncooperative ships suspected of carrying prohibited materiel were to be diverted, and determining which intercepted ships were to be boarded and searched. These standard command arrangements were soon to be modified significantly. [In addition, the list of prohibited materiel contained in the initial CINCLANTFLT OP order included both POL and "fuel and lubricants for offensive systems," neither of which was mentioned in the later JCS message.<sup>1</sup>]

549. Early on the morning of 22 October, the JCS transmitted to CINCLANT the basic blockade message and virtual operational plan which, with some subsequent modifications, was to serve as CINCLANT's fundamental policy guidance for conduct of the quarantine. The message had been prepared primarily within the Office of the CNO, who was acting as JCS representative for quarantine operations, and had been approved by the Secretary of Defense. The message still referred throughout to a "blockade"; subsequently, the terminology was to be modified to conform to the President's use of the term "quarantine."

550. Salient points in the message were:

a. General Concept of Operations The blockade would include maximum use of all available assets for collecting, reporting and

[CINCLANTFLT OP Order 45-52, op.cit. The inclusion of POL in the original CINCLANTFLT OP order was discovered about 1330 EDT on 23 October by an officer assigned to the Joint Battle Staff watch in the NMCC. This discrepancy between CINCLANTFLT's OP order and the list contained in JCS message 6848 was brought to the attention of a Deputy Director, J-3, who directed OPNAV to see that POL was deleted. (Memorandum for the record, dated 23 October 1962, TOP SECRET, in the J-3 Cuba Joint Battle Staff files.) Meanwhile, CINCLANTFLT, after receipt of JCS message 6848, had already issued a revised OP order the previous day which deleted both POL and other "fuel and lubricants for offensive systems" from the list of prohibited materials. The omission of an explicit reference to missile propellants in the list of prohibited materials prepared in Washington was not discovered until later.]

TOP SECRET

~~TOP SECRET~~

E

interpreting intelligence concerning merchant ships and aircraft<sup>1</sup> which might be carrying prohibited materiel to Cuba.<sup>2</sup> Naval operations by intercepting ships were to be carried out in such a manner that the normal positions of these ships would be outside the effective intercept range of enemy aircraft known to be operational from established Cuban bases. Should Allied or friendly nations offer assistance in enforcing the quarantine, U.S. forces would cooperate fully with the forces of nations rendering such assistance.

b. Prohibited Materiel: The original JCS message included the following: patrol craft, motor torpedo boats or other craft with armament provisions, and their armament, including surface-to-surface missiles and torpedoes; bomber and fighter-bomber aircraft; bombs, air-to-surface rockets and guided missiles; warheads for any of the above weapons; mechanical or electronic equipment to support or operate the above items; and any other items hereafter designated by the Secretary of Defense.

c. Rules of Engagement:

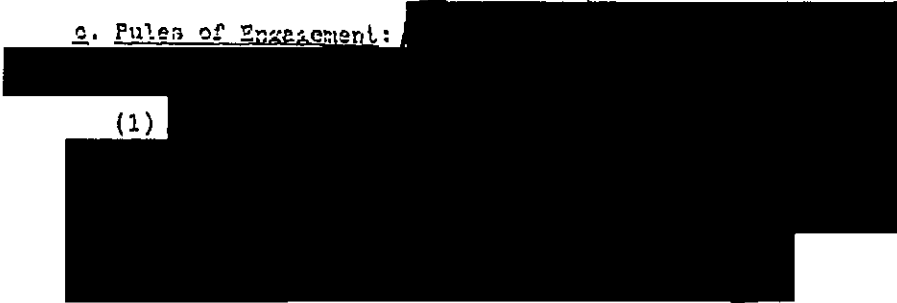

(1)

<sup>1</sup>At this time, the possibility of an air quarantine still was being considered, and in addition to detailed policy guidance concerning the establishment of the limited naval blockade, the message included guidelines which would apply should the quarantine be extended to include Soviet aircraft. However, the JCS noted that, according to intelligence indicators, most of the prohibited materiel being imported into Cuba was being carried in Communist Bloc ships. Although CINCLANT was instructed to develop plans for a blockade of aircraft, these were to be executed only upon the direction of higher headquarters.

11 AY

<sup>2</sup>As the crisis unfolded, intelligence information on the movements and cargoes of foreign ships indeed was collected and utilized in a variety of ways. However, the data on which this study is based were insufficient to permit a full analysis of the impact of such operational intelligence on quarantine decision-making processes. Therefore, this facet of the quarantine will, of necessity, be examined only cursorily.]

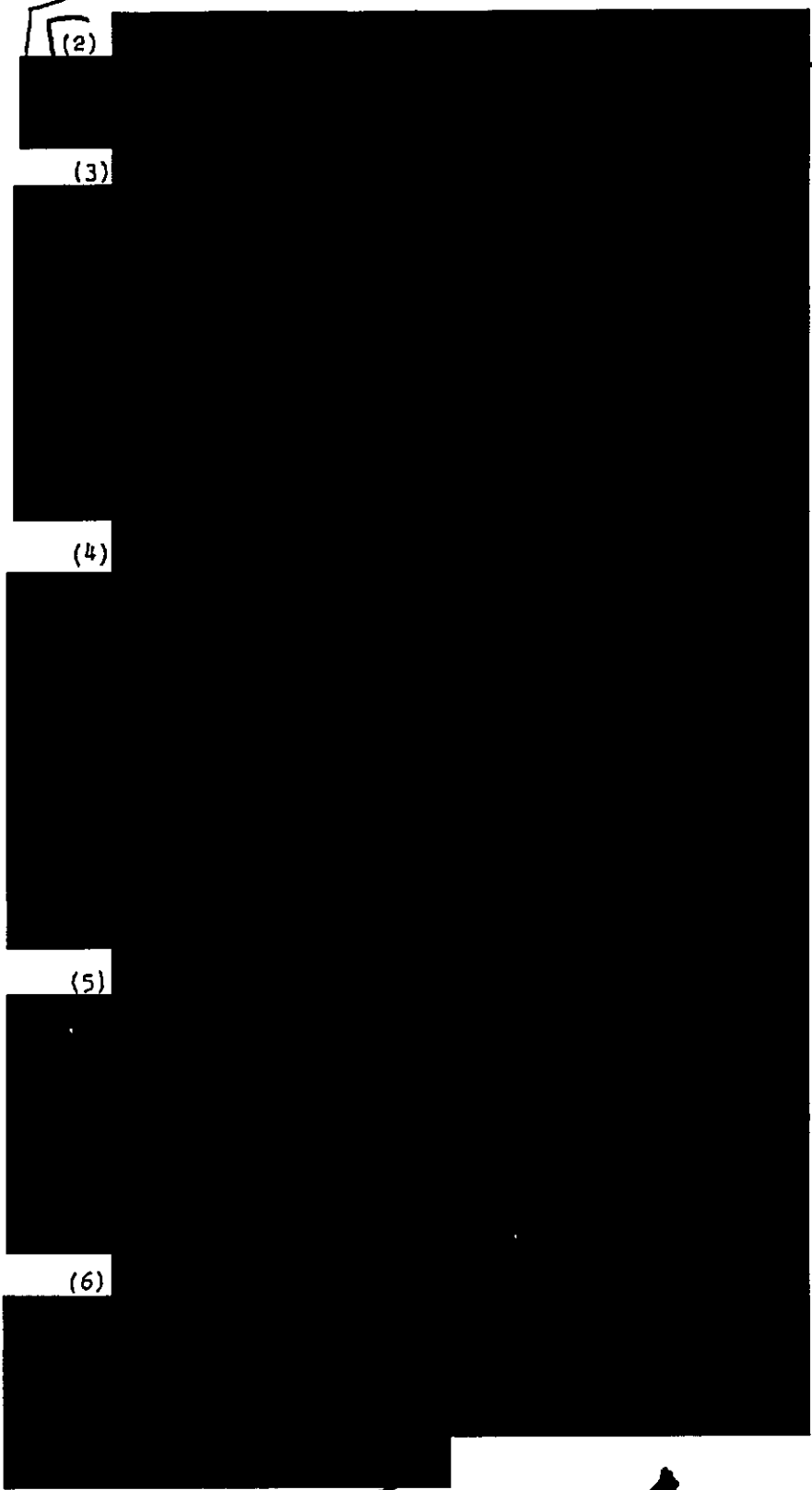

(2)

(3)

(4)

(5)

(6)

E

~~TOP SECRET~~

TOP SECRET

(7)

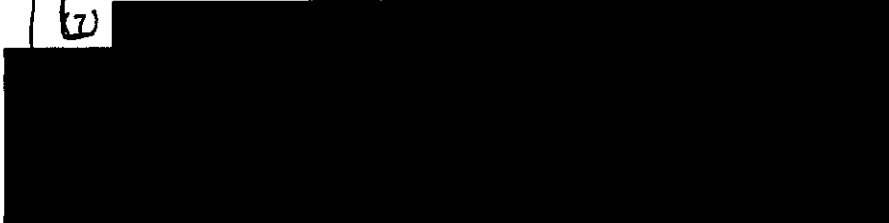

(8)

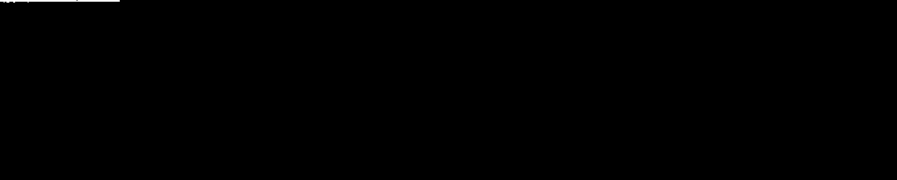

(9)

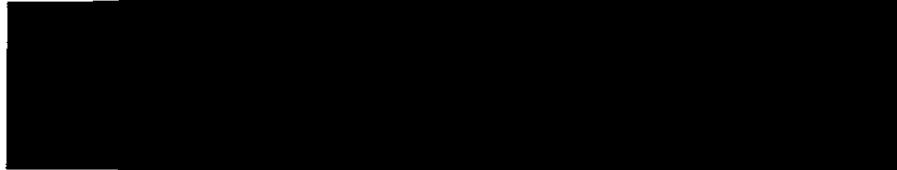

(10)



d. Defense of Guantanamo: Upon receipt of the message and prior to the imposition of the blockade, CINCLANT was directed to evacuate dependents and to reinforce Guantanamo. In addition, detailed instructions were given concerning the defense of Guantanamo and the ships and aircraft approaching and leaving the base. Specific rules of engagement were spelled out in detail.



Photoreconnaissance and other intelligence information indicated that at least twelve Soviet patrol boats of this class were operating from Cuban bases by mid-October. They were manned by Soviet crews, and each carried two missiles estimated to have a line-of-sight range of 10-12 n.mi., with each missile capable of carrying a 2,000-pound HE warhead. The KOMAR-class PGM is not estimated to be capable of reloading its missile tubes at sea. (LANTCOM, Headquarters of the Commander-in-Chief, "CINCLANT Historical Account of Cuban Crisis, 1962 (U)," 29 April 1963, TOP SECRET, page 7.)

7  
BIA  
4  
5

TOP SECRET

~~TOP SECRET~~



e. Control and Protection of U.S. Merchant Ships:

Coincident with establishment of the blockade, CINCLANT was instructed to institute protection for U.S. shipping in the Florida straits, the Yucatan Channel and the Windward Passage.<sup>1</sup> Air cover and surface forces were to be utilized as required. CINCLANT was informed that it was undesirable to institute a formal control of U.S. merchant shipping. However, he was authorized to advise ships' masters on preferred routings if he felt that this was desirable to maintain economic use of the forces assigned to the mission.

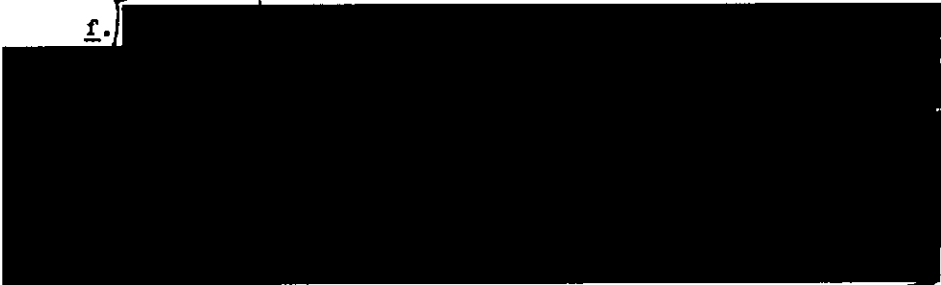

g. Reportage: The JCS stressed that prompt reports to higher authority on all incidents were absolutely essential.<sup>2</sup>

551. After receipt of this detailed guidance, CINCLANT, on 22 October, recommended several modifications of the rules of engagement to the JCS. These related primarily to tactical matters concerning the conduct of operations, and were still under review that evening.

Earlier on the 22nd, CINCLANT had informed the JCS that CINCLANTFLT had delegated to COMWESTFOR responsibility for protecting U.S. shipping in the Florida Straits and the Yucatan Channel against possible Cuban attack in response to the imposition of a blockade. COMCARIBSEAFRON was to assume responsibility for protection of shipping in the Windward Passage and for furnishing escort for the ships carrying dependents evacuated from Guantanamo back to the U.S. (CINCLANT Message to JCS, DTG 220342Z October, TOP SECRET.)

<sup>2</sup>JCS Message 6848, DTG 221111Z October, to CINCLANT et al., TOP SECRET.

552. Meanwhile, as will be recalled, CINCLANT, acting in his capacity as CINCLANTFLT, already had alerted COMSECONDFLT to prepare to command the principal naval quarantine task force (TF 136) when directed.<sup>1</sup> Within LANTCOM, therefore, COMSECONDFLT was finalizing and coordinating his plans for carrying out this assignment.

D. COMPOSITION OF THE PRINCIPAL QUARANTINE TASK FORCE (TF 136)

553. According to the concept of operations for TF 136 developed by CINCLANTFLT and COMSECONDFLT, who was to command the task force, TF 136's internal organizational structure and chain of command were to follow established Navy procedures.<sup>2</sup> Within the Task Force, there were to be three task groups, each with its own commander subordinate to COMSECONDFLT.<sup>3</sup>

554. One of these task groups, responsible for surface patrol and interception, would be designated TG 136.1<sup>4</sup> and would be

<sup>1</sup>CINCLANTFLT OP Order 45-62 to COMSECONDFLT, et al., DTG 220026Z October, TOP SECRET, op.cit.

<sup>2</sup>These procedures provide for blocks of task force numbers to be allocated to Fleet Commanders in accordance with their needs. When establishing a task force, a Fleet Commander designates the Task Force Commander and assigns specific ships and aircraft to the task force.

The Task Force Commander and his subordinate commanders then may further subdivide the task force as required by its size and the complexity of its mission. The subdivisions which may be made within a task force, listed in descending order of command echelons, are: task groups, task units, and task elements. At each command echelon within the task force, a maximum of ten subdivisions into the next lowest command echelon is permissible.

<sup>3</sup>CTF 136 OPOD 1-62, transmitted as COMSECONDFLT Message DTG 221640Z October to COMCRUDESFLT 5, COMCARDIV 13, COMDESRON 16, et al.; information copies CINCLANTFLT, CINCLANT, CNO, et al. TOP SECRET, effective for planning upon receipt and for execution when directed.

<sup>4</sup>Standard Navy procedures include the use of a decimal designation system to identify the various components of a task force. Under this arrangement, a specific number is assigned to each subdivision of the Task Force at each command echelon. The task group number appears immediately after the Task Force number and is separated from it by a decimal point. Similarly, each task unit within a task group is assigned its own additional number, which appears immediately following the task group number and is separated from it by a decimal point. Hence, the decimal designation 136.1.1, which was applied to the destroyers assigned to stations on the quarantine intercept arc during the 1962 Cuban crisis, indicated that these destroyers constituted Task Unit 1 of Task Group 1 of Task Force 136.

TOP SECRET

~~TOP SECRET~~

commanded by COMCRUDESFLT 6 in the CANBERRA. This task group was to be further subdivided into three task units, each with its own commander subordinate to COMCRUDESFLT 6. The three task units within TG 136.1 were to be:

a. A surface intercept unit (Surface Blockade Unit 136.1.1), consisting of [twelve] destroyers (DD's) and commanded by COMDESRON 26 in the USS DEWEY; and

b. Two surface patrol units (Surface Patrol Unit 136.1.2 and Surface Patrol Unit 136.1.3), each consisting of one cruiser and [two] destroyers and commanded by the commanding officers of the USS CANBERRA and the USS NEWPORT NEWS, respectively.

A destroyer intercept line was to be established on an arc with a radius of 500 miles centered at Cape Maysi, Cuba. The [twelve] DD's constituting Surface Blockade Unit 136.1.1 were to occupy stations along this arc, which was approximately 650 miles long, extending from Latitude 27° 30' N., Longitude 70° W to Latitude 20° N., 65° W. The two surface patrol units within Task Group 136.1 also would be deployed to this same general area of operations. However, unlike the DD's assigned to the intercept unit, the ships assigned to the two surface patrol units would not be expected, at times when they had not been directed to undertake a specific pursuit mission, to operate within a specified distance of a fixed station.

555. The second task group within TF 136 would be an ASW/air surveillance group (TG 136.2). Unlike TG 136.1, it would not be further subdivided. TF 136.2 was to be commanded by COMCARDIV 18 in the USS ESSEX. In carrying out ASW/air surveillance operations, the ESSEX, with [37] carrier-based aircraft, including [14] helicopters, would be assisted by the Bermuda ASW group and by the Caribbean ASW group. Aerial surveillance was to be carried out in an area eastward of a line between Bermuda and Roosevelt Roads. [Four] DD's were assigned to escort the ESSEX.

TOP SECRET

- 203 -

~~TOP SECRET~~

556. A third task group within TF 136, consisting of [two] AO's and [two] DD's, would furnish logistic support. Designated TG 136.3, it would be commanded by the commanding officer of the USS ELKOMEN.<sup>1</sup>

557. The chain of command for TF 136, then, was to proceed upward from the tactical level through the Task Force Commander (COMSECONDFLT) to CINCLANTFLT, CINCLANT, and the CNO and downward through these same channels.<sup>2</sup> Had these command arrangements actually been applied consistently during the conduct of the quarantine operations, the only deviation from established procedures in effect at the time the crisis arose would have been at the CINCLANT-CNO level. In recent years, the CINCS usually have reported directly to the Joint Chiefs of Staff as a corporate body, rather than to one of its individual members.<sup>3</sup> In this instance, however, even before TF 136 commenced operations, the CNO had been designated to serve as JCS representative for quarantine operations and the defense of Guantanamo. The fact that the CNO was serving in this capacity led, insofar as the conduct of quarantine operations was concerned, to a partial -- and temporary -- modification of the customary command relationships

<sup>1</sup>CTF 136 OPORD 1-62, op.cit., TOP SECRET.

<sup>2</sup>An organizational chart depicting these anticipated command arrangements is presented in Table I, p. 221, below.

<sup>3</sup>Under the terms of the Department of Defense Reorganization Act of 1958, the Unified and Specified Commanders assume legal responsibility for fulfilling combat missions assigned to them by the President, as Commander-in-Chief, and by the Secretary of Defense. However, in exercising direction over the Unified and Specified Commands, the Secretary of Defense is authorized by law to utilize the assistance of the Joint Chiefs of Staff. Therefore, in recent practice, operational control of the Unified and Specified Commands usually has been exercised by the Joint Chiefs of Staff, acting in behalf of the Secretary of Defense. Since 1958, when performing this function in conformity to the policy guidance of the Secretary of Defense, the Joint Chiefs of Staff usually have been directed to act as a corporate body. However, the law reserves to the President discretionary authority to direct whatever changes in the chain of command, insofar as it affects the Unified and Specified Commanders, that he, as Commander-in-Chief, may determine to be necessary. With prior approval of the President, then, the Secretary of Defense can direct that the Joint Chiefs of Staff modify the procedures under which operational control over Unified and Specified Commanders is exercised. This prerogative was applied during the 1962 Cuban crisis.



TOP SECRET

~~TOP SECRET~~

between the JCS and CINCLANT. With the CNO authorized to act in behalf of the entire JCS on quarantine matters, the command relationships which were established during the planning phase of the naval quarantine closely resembled those which had been commonplace before major changes in the command structure<sup>1</sup> were introduced in 1958.

558. As the crisis unfolded, the command arrangements which actually were applied to the conduct of quarantine operations were to differ significantly from those which had been anticipated when TF 136 was organized. These actual command arrangements subsequently will be described in some detail. They were to prove to be an admixture of initial dramatic deviations from traditional patterns, followed by a temporary reversion to those patterns, and finally, again a departure -- but less dramatic -- from tradition.

559. Irrespective of what command arrangements actually were to apply to the conduct of the quarantine, by 1240 EDT on 22 October COMSECONDFLT, in his capacity as Commander, TF 136 had issued his initial OP Order concerning the composition and concept of operations for the task force.<sup>2</sup> This OP order was effective for planning upon receipt and for execution when directed. Before U.S. intentions were publicly disclosed by the President, then, the forces required to implement the quarantine had been organized and were reaching a high state of operational readiness for their mission.

---

<sup>1</sup>Prior to enactment of the Department of Defense Reorganization Act of 1958, an "Executive Agent" procedure had been utilized. Under this arrangement, the Unified Commands were allocated among the various Services. Actual direction of the respective Unified Commanders was exercised, not by the Joint Chiefs of Staff as a corporate body, but by the appropriate individual Service Chief acting in the capacity of an executive agent for the JCS.

The 1958 legislation was intended, among other things, to furnish a basis for modifying these former command relationships. However, under the new act, the President, as Commander-in-Chief, retained discretionary authority to effect whatever changes in the chain of command between himself and the CINCS that events might require. Such changes may be introduced at any time.

<sup>2</sup>CTF 136 OP ORD 1-62, transmitted as COMSECONDFLT Message DTG 221640Z October, op.cit., TOP SECRET.

TOP SECRET

- 205 -

~~TOP SECRET~~

TOP SECRET

~~TOP SECRET~~

560. In addition, within the theater, steps had been taken to reinforce the U.S. base at Guantanamo. The last dependents were evacuated from Guantanamo shortly before the President began his address.

561. Before describing the actual quarantine operations which TF 136 subsequently conducted, it is necessary to recall briefly relevant decisions and actions being taken in Washington at the highest national levels.<sup>1</sup>

#### E. THE FIRST PRESIDENTIAL PRONOUNCEMENT

562. At 1900 EDT on 22 October, the President, as scheduled, began to deliver over the radio and television networks the address which publicly disclosed the U.S. decision to impose the naval quarantine as a first step in its response to the crisis. He announced the Soviet introduction of MRBM's and IRBM's into Cuba, stressed U.S. objections to this aggressive act, and outlined a program of action aimed at preventing any further build-up of Soviet offensive capabilities in Cuba and accomplishing the removal of those missiles and fighter-bombers already deployed to the island. The President stated that he had directed that seven initial steps be taken immediately. These were:

a. A strict quarantine on all offensive military equipment under shipment to Cuba would be initiated; all ships bound for Cuba from whatever point of origin would be turned back if found to contain cargoes of offensive weapons. If necessary, the quarantine later would be extended to other types of cargo and carriers. However, as an initial step, the U.S. did not intend to interfere with traffic bringing food and other necessities to the Cuban people, as the Soviets had done during their blockade of Berlin in 1948.

---

<sup>1</sup>Some of these already have been discussed, in a somewhat different context, in the earlier chapter on the U.S. decision. See pp. 85-90.

TOP SECRET

- 206 -

~~TOP SECRET~~

~~TOP SECRET~~

b. Close surveillance of the military build up in Cuba would continue, and the U.S. armed forces had been directed to be prepared for any eventualities.

c. Any nuclear missile launched from Cuba against any nation in the Western Hemisphere would be regarded as an attack on the United States by the Soviet Union, requiring full retaliation upon the USSR.

d. The U.S. base at Guantanamo had been reinforced, dependents evacuated, and additional military units alerted to assist in the defense of Guantanamo if required.

e. The U.S. was calling for an immediate meeting of the Organ of Consultation, under the OAS, to consider the Soviet threat to hemispheric security and to invoke the appropriate articles of the Rio Treaty in support of all necessary action.

f. The U.S. was asking under the U.N. Charter for an emergency meeting of the Security Council and intended to introduce a resolution calling for the prompt dismantling and withdrawal of all offensive weapons in Cuba under U.N. supervision before the quarantine could be lifted.

g. Premier Khrushchev was requested to halt and eliminate this clandestine and provocative threat to world peace.

563. The President also warned that any hostile move anywhere in the Free World, including Berlin, would be met by whatever action was required.<sup>1</sup>

564. The arrangements which were made to inform and coordinate with Allied states -- especially in NATO Europe and in Latin America -- prior to and simultaneously with the President's speech have been described elsewhere in this study and need not be repeated here. It is well to recall, however, that shortly after the President spoke, the State Department sent to all embassies and posts an amplification of the meaning of his remarks for use in their discussions with local governments.<sup>2</sup> In addition, on

<sup>1</sup>The Department of State Bulletin, Vol. XLVII, No. 1220, 12 November 1962, pp. 715-720, UNCLASSIFIED.

<sup>2</sup>Further details may be found in Chapters III and IV of this historical analysis.

~~TOP SECRET~~

~~TOP SECRET~~

TOP SECRET

Sunday evening, 21 October, the text of the President's speech, with a covering letter to Premier Khrushchev, had been sent to Embassy Moscow for delivery to the Soviet Foreign Office one hour before the President began his address.<sup>1</sup>

F. REVISED COMMAND PROCEDURES

565 Although President Kennedy had not referred to a grace period in his public speech, the quarantine planners had envisaged that the first intercept would occur between 24 and 48 hours after the initial public announcement of U.S. intentions. It soon was to become apparent that the command procedures which had been established prior to the public announcement of U.S. intentions were not to apply during the actual conduct of the initial intercept operations.

566 Shortly before midnight on 22 October, the Secretary of Defense, the CNO, and their principal aides conferred at the Pentagon on implementation of the quarantine and arrangements for surveillance. After visiting CNO Flag Plot and Intelligence Plot to obtain the latest information on the positions of ships, the Secretary of Defense and the CNO apparently agreed that the initial interception should involve a Soviet ship, and should be made as soon as possible after the termination of the grace period.<sup>2</sup> At this time, the most likely candidate still was the Soviet merchant ship POLTAVA, and since CINCLANT already had alerted COMSECONDFLT to this fact, no new instructions to TF 136 were required.<sup>3</sup>

567 Shortly after midnight (EDT), in an early hour of 23 October, the JCS dispatched to CINCLANT revisions to the basic guidance on quarantine operations which had been furnished early

<sup>1</sup>"Chronology of the Cuban Crisis...", op.cit., p. 7.

<sup>2</sup>CNO Flag Plot Log, TOP SECRET.

<sup>3</sup>Ibid.

TOP SECRET

- 203 -

~~TOP SECRET~~

the previous day.<sup>1</sup> The changes were primarily editorial, and were designed to correlate the language and tone of the previous JCS directive with that of the President's speech. In addition, as CINCLANT had suggested, commanders of intercepting ships were authorized to permit any vessel which had been boarded and found not to be carrying prohibited materiel to proceed to Cuba. Commanders of intercepting ships also were authorized to designate the course to be followed by any ship believed to be carrying prohibited materiel which elected to proceed to a non-Cuban port.<sup>2</sup> The latter measure was designed to improve the capabilities of the quarantine force to maintain surveillance if this contingency arose.

563. That CINCLANT had found it necessary to obtain explicit JCS approval before delegating tactical decisions like those described above to the TF 136 Commander foreshadowed the command arrangements which actually were to apply when the initial intercepts occurred. However, the new JCS terms of reference still authorized CINCLANT to designate the ships to be intercepted. Therefore, at 1214 EDT on 23 October, in his capacity as CINCLANTFLT, CINCLANT directed that the NEWPORT NEWS proceed to intercept the POLTAVA at 241400Z October and that the ESSEX proceed to intercept the KIMOYSK at the same hour.<sup>3</sup>

569. Shortly thereafter, a revised version of CINCLANTFLT's OP Order 45-62 was dispatched to the quarantine task force. The revisions consisted of editorial modifications and other changes required by the two policy directives which had been received from the JCS since CINCLANTFLT's original OP order concerning the quarantine had been issued. Furthermore, certain command

<sup>1</sup>This message also was drafted primarily within the Office of the CNO, who was serving as JCS representative for quarantine operations. However, in accordance with established precrisis procedures, it, like the basic blockade message which had been dispatched earlier, was coordinated within the JCS organization and transmitted as a JCS communication.

<sup>2</sup>JCS Message 6896 to CINCLANT, et al., DTG 230609Z October, 1962  
SECRET.

<sup>3</sup>CINCLANTFLT message to COMSECONDFLT, DTG 231614Z October, 1962  
TOP SECRET.

TOP SECRET

~~TOP SECRET~~

authority previously delegated to the TF 136 Commander now was explicitly reserved to CINCLANTFLT. No ship not designated for interception by CINCLANTFLT was to be interfered with, except in the event of hostile attack. No ship designated for interception was to be boarded or searched without CINCLANTFLT's authorization.

570. The revised OP order also designated the ports to which ships taken into custody were to be diverted unless otherwise directed by CINCLANTFLT or the quarantine commander. These were: Fort Lauderdale, Florida; Charleston, South Carolina; and Roosevelt Roads or San Juan, Puerto Rico.<sup>1</sup> Upon arrival at these ports, the ships taken into custody were to be chopped to the Coast Guard. Special Coast Guard units meanwhile were being assigned to these ports to assume OPCON of diverted ships.

#### G. THE SECOND PRESIDENTIAL PRONOUNCEMENT

571. Meanwhile, during the afternoon of 23 October, the OAS had adopted a resolution unanimously backing the quarantine and urging the immediate removal of Soviet missiles from Cuba. In New York, at the U.N., a debate was under way in the Security Council. Early in the evening, at the White House, the President affixed his signature to the proclamation on the interdiction of the delivery of offensive weapons to Cuba. The Presidential proclamation ordered implementation of the quarantine beginning at 1400Z (1000 EDT) on 24 October. The list of prohibited materiel it contained conformed closely to the one originally transmitted to CINCLANTFLT by the JCS on 22 October. [Both had failed to mention missile propellants explicitly. The omission was not discovered and corrected until 25 October, and missile fuels were not formally added to the list of prohibited materiel by the Secretary of Defense until 27 October].<sup>2</sup>

<sup>1</sup>CINCLANTFLT message to COMSECONDFLT, et al., 231710Z October, 1962 SECRET.

<sup>2</sup>JCS Message 6978 to CINCLANT, 251759Z October, 1962 UNCLASSIFIED: "OPNAV 24-Hour Resume of Events, 2700 to 2800Z October," TOP SECRET.

TOP SECRET

- 210 -

~~TOP SECRET~~

572. As the President was signing the interdiction proclamation, a message, drafted within JCS earlier in the day, directing CINCLANT to execute the naval quarantine plan, was dispatched. It altered the previously developed command arrangements in only one respect; authority to order strikes against the bases of any hostile Cuban force which attacked Guantanamo was delegated to the local commander.<sup>1</sup> The earlier rules of engagement for the quarantine had required explicit JCS approval before such strikes could be initiated.

573. Shortly after 2000 EDT, the CNO, the Secretary of Defense, and the Deputy Secretary of Defense again visited CNO Flag Plot and the OPNAV Intelligence Plot to be briefed on the latest positions of ships assigned to the quarantine force and of incoming merchant ships.<sup>2</sup>

574. By this time; several arrangements also were in effect to ensure that the Chairman, JCS, was kept fully cognizant of quarantine developments. The special J-3 Blockade (i.e., Quarantine) Watch was preparing a written brief of significant developments which had occurred during each watch period. These memoranda were addressed to the Executive Officer to the Chairman, JCS, and were personally delivered to the Office of the Chairman by the J-3 officer who had stood the special Quarantine Watch. (Copies of these memoranda also were circulated within J-3, but available data are insufficient to permit reconstruction of the details.) It also was the responsibility of the special Quarantine Watch Officer to attend the briefings on Cuban developments being conducted for the Chairman, JCS, by a Deputy Director, J-3, each morning at 0800 Washington time. At these briefings, the special Quarantine Watch Officer was expected to be prepared to answer questions as required. (An OPNAV Watch Officer from CNO Flag Plot

<sup>1</sup>JCS Message 6916 to CINCLANT, et al., DTG 232304Z October, 1962  
SECRET.

<sup>2</sup>CNO Flag Plot Log, TOP SECRET.

TOP SECRET

also attended these 0800 briefings for the same purpose. Presumably, the written briefs on quarantine developments being prepared within OPNAV also were being circulated to the Office of the Chairman, JCS.)<sup>1</sup>

H. INITIAL INTERCEPTS: MODIFICATION OF TRADITIONAL COMMAND ARRANGEMENTS

575. After CINCLANT had received the JCS message directing him to execute the naval quarantine plan, he had directed CTF 136 (COMSECONDFLT) formally to activate his task force. During the night of 23-24 October, the destroyers assigned to stations on the quarantine line moved towards their positions. All stations on the line were expected to be filled by 1800 Washington time on 24 October.<sup>2</sup> In addition, during the night, the ESSEX and the NEWPORT NEWS were following a course designed to enable them, as they earlier had been directed, to intercept the Soviet ships POLTAVA and KIMOYISK at 1000 Washington time the following morning (24 October).<sup>3</sup> This hour was, of course, the very one when, according to the President's proclamation, the quarantine would go into effect.<sup>4</sup>

<sup>1</sup> Further details on the 0800 J-3 briefings for the Chairman, JCS, may be found in Enclosure 3 of this study. The role of CNO Flag Plot is discussed at greater length in Appendix B to Enclosure D.

<sup>2</sup> J-3 briefing for WJCS, 0800G 24 October, TOP SECRET.

<sup>3</sup> CINCLANTFLT message to COMSECONDFLT (CTF 136), DTG 231614Z October, TOP SECRET, *op.cit.*

<sup>4</sup> Note that CINCLANT, in his capacity as CINCLANTFLT, instructed CTF 136 to carry out these two intercepts at this precise hour even before the President had affixed his signature to the official proclamation and before the JCS formally had directed execution of the quarantine plan. The first action preceded the second and the third by approximately five hours. CINCLANTFLT's intercept instructions to CTF 136 were dispatched at 1214 EDT on 23 October. (The relevant message is referenced in footnote 3, above.) The President recorded the time he signed the proclamation as 1906 EDT. (A facsimile of this Presidential notation may be found in The Department of State Bulletin, Vol. XLVII, No. 1220, November 12, 1962, p. 717, UNCLASSIFIED.) The relevant JCS message was dispatched at 1904 EDT. (JCS Message 6916 to CINCLANT *et al.*, DTG 232304Z October, SECRET.)

This bit of evidence suggests that CINCLANT was being kept closely informed, (by means of secure voice circuits, of important developments evolving in Washington. Undoubtedly, this coordination was accomplished primarily through the CNO, acting in his capacity as JCS representative for quarantine operations and the defense of Guantanamo. Although this aspect of the conduct of the quarantine is relevant to an analysis of command and control, available data unfortunately did not suffice for a detailed reconstruction of the use of secure voice links during the crisis.

TOP SECRET



576. By 1000 EDT on the 24th, the ESSEX was closing in on the KIMOYSK. According to the command arrangements which earlier had been agreed upon and which conformed to the traditional pattern, CINCLANT, who had ordered the intercept, had been furnished with all the policy guidance required to carry out quarantine operations. The Commander, TF 136, was directly responsible to CINCLANT through CINCLANTFLT. Nevertheless, the Deputy CNO for Fleet Operations and Readiness, who was on duty at the CNO Policy Watch at the time, requested White House guidance on the instructions to be forwarded to the ESSEX. He was told that surveillance was to be maintained but that the ship was not to be intercepted. These instructions were transmitted directly to the ship's commander.<sup>1</sup>

577. By 1000 EDT on 24 October, the Soviet merchant ship POLTAVA, which was scheduled to be intercepted at that hour by the NEWPORT NEWS, apparently had reversed its course and had turned back towards the USSR. The fourteen other POLTAVA-class ships which in addition to the KIMOYSK and the POLTAVA, had been bound towards Cuba also were beginning to show signs of erratic behavior.<sup>2</sup> Ships of this class, which were estimated to be capable of carrying missiles in their holds, were of primary interest as intercept targets. [Perhaps it was the receipt of intelligence indicators that these vessels might have been instructed by Moscow not to proceed to Cuba that prompted the CNO Policy Watch Duty Officer to seek White House guidance on the intercept of the KIMOYSK by the ESSEX. If this hypothesis is correct, the chain of command which, in ordinary circumstances, would have been used to relay

<sup>1</sup>CNO Flag Plot Log, TOP SECRET. According to this source, the instructions were transmitted as CNO message DTG 241451Z October to COMCARDIV 18 (CDR, TG 136.2) in the ESSEX and "all key officials (DOD/Navy) [were] notified."

<sup>2</sup>[Information on the turn-around ships of the POLTAVA class still is closely held, and the exact time sequence involved in their reversal of course is not disclosed in the data upon which this account is based. However, indirect evidence suggests that the POLTAVA was among the first to turn around.]

TOP SECRET

~~TOP SECRET~~ L

[Instructions to the ESSEX was bypassed to ensure that the revised orders would reach the intercepting U.S. vessel at the earliest possible moment.]

BIAV

578. By the evening of 24 October, Washington time, Soviet tanker also were moving towards the quarantine area. Whether or not the Soviet Union had ordered all the POLTAVA-class ships to turn around still was unclear. According to Navy Flag Plot calculations, a Soviet tanker, the BUCHAREST, would pass near the ESSEX during the night. The CNO, through his Executive Officer, requested White House guidance on the advisability of sending ships to intercept tankers. At about 2140 EDT, the Secretary of Defense again visited CNO Flag Plot. He was informed that the estimated time of contact between the BUCHAREST and the ESSEX was approximately 250200 EDT. The Secretary instructed that he be called in time to return to Flag Plot and make the decision on whether or not to intercept the tanker. Subsequently, more reliable surveillance reports were received, and revised calculations on the positions and speeds of the two ships revealed that, if they both remained on their present course, contact between the ESSEX and the BUCHAREST was not even remotely likely.<sup>1</sup> In the meantime, all sixteen of the POLTAVA-class ships which earlier had been headed for Cuba had begun to reverse their courses and to turn eastward.<sup>2</sup>

579. When it had become apparent that all the Soviet ships of primary interest were turning away from the quarantine line, shortly after midnight COMSECONDFLT (Commander, TF 136) directed that the

<sup>1</sup>CNO Flag Plot Log, TOP SECRET.

<sup>2</sup>Memorandum, "Significant Items for 250830Z J-3 Briefing for CJCS, TOP SECRET. Presumably, this memorandum was prepared by the Quarantine (i.e., Blockade) Watch. At approximately the same time, CINCLANT reported to the JCS that, on the basis of the information available to him, eight of the POLTAVA-class merchant ships bound for Cuba had reversed their course. (CINCLANT STTREF as of 251200Z October, transmitted as CINCLANT message 251324Z October to AIG 930, et al., TOP SECRET.)

TOP SECRET

- 21 -

~~TOP SECRET~~

TOP SECRET

~~TOP SECRET~~ E

ESSEX and [two] DD's proceed to intercept the BUCHAREST and to maintain contact. The tanker was not to be stopped pending instructions from CINCLANTFLT. COMSECONDFLT's flagship had increased speed and also was moving towards the BUCHAREST.<sup>1</sup> By 0800 EDT on 25 October, CINCLANTFLT had directed COMSECONDFLT to intercept the Soviet tanker.<sup>2</sup> The ESSEX and [eight] destroyers were maintaining surveillance of the BUCHAREST, and the NEWPORT NEWS with [four] destroyers was closing in. Earlier, the Vice Chief of Naval Operations had instructed COMASWFORLANT in the ESSEX to ensure that the BUCHAREST did not slip through the quarantine line. He also had directed that additional efforts be made to secure photographs of the Soviet POLTAVA-class merchant ships which had turned around and were moving eastward.<sup>3</sup>

580. During the night of 24-25 October, then, events had introduced a requirement to collect as much information as possible on the turn-around ships and simultaneously to locate and identify other merchant ships headed for Cuba. Therefore, photoreconnaissance and aerial surveillance activities increased sharply.<sup>4</sup> [About 0300 EDT on the 25th, CINCSAC implemented his "Blue Banner" OPLAN designed to assist in detecting, identifying and reporting on merchant ships in CINCLANT's surveillance area.<sup>5</sup>] By 0900 EDT,

<sup>1</sup> COMSECONDFLT SITSUM to CINCLANTFLT, 250500Z October, SECRET.

<sup>2</sup> CINCLANT's SITREP as of 251200Z October, transmitted as CINCLANT message 251304Z October to AIG 930, et al., TOP SECRET.

<sup>3</sup> CNO Flag Plot Log, TOP SECRET.

<sup>4</sup> Of course, information on ships headed for Cuba and their cargoes also was being received from other sources, both covert and overt. However, these data had to be supplemented by actual sightings in order to plot the precise locations of the incoming ships on the high seas, their estimated courses and times of arrival in the quarantine area, etc. BIA

<sup>5</sup> CINCSAC message 250717Z October to AIG 930, SECRET. [The fact that the SAC aircraft assigned to this mission reported each sighting in messages directed to a large number of action addressees apparently accounted for the tremendous upsurge in the number of incoming JCS messages during this period. See Enclosure C to this study for further details on the latter point.]

TOP SECRET

- 215 -

~~TOP SECRET~~

approximately six hours later, SAC aircraft assigned to the "Blue Banner" mission had reported locating 108 merchant ships in the Atlantic. Of these, seven were believed to be of USSR or Soviet Bloc registry.<sup>1</sup> Steps also were taken to reinforce the ASW/air surveillance task group within TF 136. Task Group ALPHA, commanded by COMCARDIV 16 in the RANDOLPH, was assigned to provide additional ASW/air surveillance support in the general vicinity of the quarantine line.<sup>2</sup>

581 So concerted was the photoreconnaissance effort during the night that the master of one Soviet ship even reported to Moscow that he had been fired upon on the high seas by low-flying American aircraft. The incident provoked a formal protest note from the Soviet government a few days later. Upon receipt of the note, full reports on the incident were requested of CINCLANTFLT. The "shots" turned out to be magnesium photoflash cartridges dropped during the height of the U.S. effort to photograph the Soviet ships turning away from the quarantine line.<sup>3</sup>

582 As has been mentioned already, while the various forces assigned to reconnaissance missions were carrying out their tasks, during the night of 24-25 October the ESSEX, with [eight] destroyers, and the NEWPORT NEWS, with [four] destroyers, had been moving into

<sup>1</sup>J-3 briefing for CJCS, 260830Q October, TOP SECRET.

<sup>2</sup>In addition to the requirement for increased aerial surveillance, at the time the quarantine went into effect intelligence had indicated the probable presence of some Soviet submarines near the quarantine area. Shortly thereafter, a total of six positive sightings of Soviet conventionally powered submarines in the approaches to the Caribbean had been reported. Once they had been discovered, all the submarines began a return to the bases of the Soviet Northern Fleet, and apparently no replacements for them were deployed. In retrospect, after analysis of photographs and other data, it was estimated that a total of four Soviet submarines were deployed to the Caribbean area and that all returned to their home bases shortly after the quarantine was imposed. (LANTCOM, "CINCLANT Historical Account of the Cuban Crisis, 1952 (U)," op.cit., p. 11, TOP SECRET.)

<sup>3</sup>Message from U.S. Embassy Moscow to Department of State, No. 1114, 28 October 1952, readdressed to CINCLANTFLT, TOP SECRET; CINCLANTFLT message to CNO, DTG 282032Z October, TOP SECRET. Receipt of the Soviet protest note and the subsequent attempt to establish in detail what actually had happened also stimulated a series of telephone conversations between the staffs of the CNO and LANTCOM. (CNO Fla. Plot Log, TOP SECRET.)

TOP SECRET

~~TOP SECRET~~

position to intercept the Soviet tanker BUCHAREST. These elements of TF 136 had not been directed to board the Soviet tanker, and under the rules of engagement governing quarantine operations this decision was reserved to CINCLANTFLT -- or to even higher authority

583. By 0915 EDT on 25 October, reconnaissance had confirmed that the BUCHAREST carried no cargo on deck.<sup>1</sup> She was kept under surveillance. Meanwhile, another Soviet tanker, the VINNITSA, had passed through the quarantine line and was proceeding to Havana. She was to be reported by patrol ships operating in the Windward Passage and along the north coast of Cuba when she arrived in that area.<sup>2</sup>

584. Throughout the morning of the 25th, the flurry of activity in the vicinity of the quarantine line continued. The DD PIERCE had made contact with the Lebanese freighter MARUCLA, which earlier had reported a cargo of sulphur, paper, machinery, trucks and spare parts. The MARUCLA was known to be under Soviet charter. CINCLANTFLT directed that the PIERCE stop and board the MARUCLA, but before receipt of the message the PIERCE had left the vicinity and had begun to trail another contact, the East German passenger ship VOLKERFREUND SCHAFT.<sup>3</sup>

585. Some temporary confusion had arisen when a garble in a single sideband transmission from COMSECONDFLT to CINCLANTFLT resulted in misidentification of the MARUCLA as the ZARUWI, but the problem soon was cleared up.<sup>4</sup> CINCLANTFLT then directed that

<sup>1</sup>CNO Flag Plot Log, TOP SECRET.

<sup>2</sup>Memorandum, "Significant Items for 250800Q J-3 Briefing for CJCS," TOP SECRET. Presumably, this memorandum was prepared by the Quarantine (i.e., Blockade) Watch.

<sup>3</sup>CINCLANTFLT message DTG 251528Z October to COMSECONDFLT, information CNO and USS PIERCE, UNCLASSIFIED; "OPNAV 24-Hour Resume of Events, 2500Q to 2500Q October," TOP SECRET.

<sup>4</sup>The amount of priority traffic which had to be carried on the CW communications links between CINCLANT/CINCLANTFLT's headquarters and CTF 136 was increased by the fact that, during the initial period of quarantine operations, many tactical decisions were made in Washington at the highest levels. Therefore, when feasible, at these echelons the single sideband voice radio link was utilized in order to expedite the communications flow. (LANTCOM, Headquarters of the Commander-in-Chief, "CINCLANT Historical Account: Cuban Crisis, 1962 (U)," 29 April 1963, TOP SECRET, p. 208.)

TOP SECRET

~~TOP SECRET~~

TOP SECRET

~~TOP SECRET~~

a DD from the Logistic Support Group reestablish contact with the MARUCLA. By 1447 EDT, the J. P. KENNEDY was enroute.<sup>1</sup> Meanwhile, the NSC had met at the White House during the morning. Having been briefed on the military situation, the President issued policy instructions covering interdiction and inspection of non-Bloc ships.<sup>2</sup>

586. At 2107 EDT, CNO Flag Plot received a copy of a message indicating that the MARUCLA had been located by a carrier-based surveillance aircraft and that the PIERCE was proceeding to join the J. P. KENNEDY for the intercept, since it was in the vicinity. Soon thereafter, at 2140 EDT, Flag Plot received word that the Secretary of Defense would visit Flag Plot shortly in order to make the decision on the intercept of the MARUCLA. The PIERCE exchanged messages with the MARUCLA and verified its destination as Cuba and its cargo as sulphur. Visual observation showed trucks on the deck. The KENNEDY was expected to be alongside by first light. At 2230 EDT, the Secretary of Defense, the Deputy Secretary of Defense, and CNO officials arrived at Flag Plot following a visit to CNO Intelligence Plot. They remained about 10 minutes.<sup>3</sup> Presumably, the decision to direct the KENNEDY to intercept and board the MARUCLA was made at this time. Although available data do not permit a precise reconstruction, they do suggest that this decision was made at the highest levels.<sup>4</sup> Apparently, CINCLANT --

<sup>1</sup>OPNAV 24-Hour Resume of Events..., "op.cit.", TOP SECRET.

<sup>2</sup>"Chronology of the Cuban Crisis...", "op.cit.", page 11.

<sup>3</sup>CNO Flag Plot Log, TOP SECRET; "OPNAV 24-Hour Resume of Events," "op.cit.", TOP SECRET.

<sup>4</sup>Throughout the quarantine, a number of decisions seem to have been made in the course of conversations between high-ranking civilian and military officials (on the secure telephones linking the Pentagon to the White House). However, the data utilized for this analysis are insufficient for an accurate recapitulation either of the decisions which were made in this manner, or of how this practice affected the command and control process. We do know that the President, earlier in the day, had furnished to the NSC, of which the Secretary of Defense is a member, policy guidance on the interdiction and inspection of non-Bloc ships.

TOP SECRET

- 218 -

~~TOP SECRET~~

TOP SECRET

~~TOP SECRET~~

who also holds the position of CINCLANTFLT -- and the Commander of TF 136 were informed ex post facto of the instructions transmitted from Washington to the DD KENNEDY.

587. While attention at the highest levels still was concentrated on formulating a decision concerning the interception of the Lebanese ship MARUCLA, the East German passenger ship VOLKERFREUND SCHAFT, bound for Havana, and a British ship bound for Jamaica passed through the quarantine line. The NEWPORT NEWS and her destroyer escort had broken away from the group still shadowing the BUCHAREST and were returning to roving patrol in the center of the quarantine line.<sup>1</sup> Shortly thereafter, the tanker BUCHAREST -- the second Soviet ship to cross the line -- was cleared to proceed without having been boarded.

588. By 0725 EDT on 26 October, a boarding party from the J. P. KENNEDY was preparing to board the MARUCLA and was aboard the Lebanese freighter by 0750. The boarding party returned at 1020 reporting no incidents, no prohibited material in evidence, and all papers in order. The boarding party obtained a copy of the ship's manifest, confirmed its cargo, and cleared it to proceed to Havana on a designated course via Providence Channel. Although all holds were battened down and inaccessible, one was opened for inspection in order that "electro-measuring instruments" listed on the manifest could be examined. The KENNEDY was maintaining surveillance pending instructions.

589. The Soviet merchant ship GROZNYI also was being trailed, but during the night of 25-26 October, contact with the GROZNYI was lost. CINCLANTFLT directed that in the event contact was not regained and held during the night a search was to be conducted beginning first light 25 October by aircraft from Roosevelt Roads and Bermuda.<sup>2</sup> Contact was reestablished, and by 1000 EDT on

<sup>1</sup>"OPNAV 24-Hour Resume of Events," op.cit., TOP SECRET.

<sup>2</sup>CINCLANTFLT message to COMSECONDFLT, DTG 250228Z October, SECRET.

TOP SECRET

~~TOP SECRET~~

TOP SECRET

~~TOP SECRET~~

26 October, the LAWRENCE, after having been refueled by the NEWPORT NEWS, was en route to intercept the GROZNYI. The ship was not to be stopped or boarded until directed.<sup>1</sup>

590. By the time the LAWRENCE was alongside, the GROZNYI was dead in the water. The LAWRENCE subsequently was recalled from the intercept and instructed to report its observations but not to board the ship unless so directed.<sup>2</sup>

591. As the first three days of quarantine operations drew to a close, there was considerable ambiguity about the command arrangements which actually were to apply to TF 136. Certain intercept decisions had been taken at the highest levels, and CINCLANT, CINCLANTFLT, and the Task Force Commander presumably had been bypassed in several instances. The primary reason for these modifications of the expected command arrangements for TF 136 was the fact that all but one of the principal targets for intercept -- Soviet ships of the POLTAVA class -- had turned away from Cuba before arriving at the designated intercept area. This development had necessitated ad hoc decisions, the need for which had not been fully anticipated during the planning for the quarantine. The single POLTAVA-class ship with which contact had been established the KIMOYSK -- had not been stopped or boarded at the direction of the highest authority.

592. The JCS itself was not directly involved in this aspect of the decision-making process. However, the CNO, as JCS representative for quarantine operations, and his deputies served as the direct point of contact between higher civilian authority and the ships assigned to TF 136. Hence, the actual command arrangements utilized during this period were an admixture of those which had been set up before TF 136 was operational and dramatic departures therefrom. Figure 1 depicts the intended command structure;

<sup>1</sup> COMSECONDFLT message to CINCLANTFLT, DTG 260100Z, October, 1962  
SECRET

<sup>2</sup> COMSECONDFLT message to CINCLANTFLT, information CNO, CINCLANT and JCS, DTG 260500Z October, 1962 SECRET.

TOP SECRET

- 220 -

~~TOP SECRET~~



Figures 2 and 3 show the chain of command actually utilized after contact was established with the KIMOYSK and the MARUCLA, respectively. Command arrangements similar to those depicted in Figures 2 and 3 also apparently had been utilized for other intercept decisions during this three-day period.

#### I. INTEGRATION OF POLITICAL AND OPERATIONAL REQUIREMENTS

593. The requirement that conduct of the quarantine operations and other military readiness preparations be closely integrated with developments in the international political arena reached its climax on 27 and 28 October. Yet, during this critical period command and control of the quarantine force reverted to more traditional channels.

594. On the 26th, two letters from Premier Khrushchev to President Kennedy had been received. The later one, which had arrived in Washington shortly before midnight, was highly emotional and seemed to reflect the deep concern of the Soviet leader that a direct military confrontation with the U.S. must be avoided at all costs. In addition, Khrushchev had written to the U.N. Secretary General, accepting his earlier suggestion that Soviet ships stay out of the quarantine area.

595. In contrast with the three previous days, there was little activity in the vicinity of the quarantine line on the 27th. Early in the morning, CINCLANTFLT had directed that the [two] DD's earlier designated to intercept the only Soviet ship with which contact had been established, the GROZNYV, stay out of sight and track the Soviet ship by radar. The GROZNYV remained dead in the water all day, finally getting under way again about 2100 PM Washington time. The only other ships under surveillance were the MARITSA, of Lebanese registry, and the Greek ship PELLA. CINCLANT had directed an intercept of the MARITSA. The PELLA was also to be intercepted in the vicinity of the quarantine line,

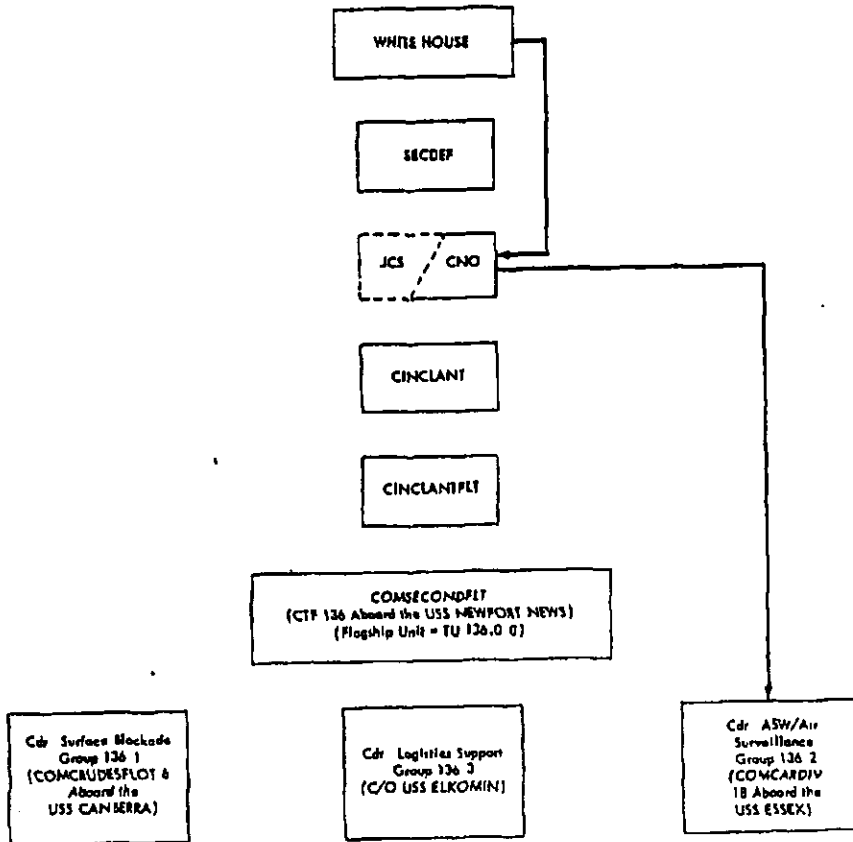

FIGURE 2. Command Arrangements Utilized in Decision Concerning Intercept of KIMOYSK, 24 October 1962

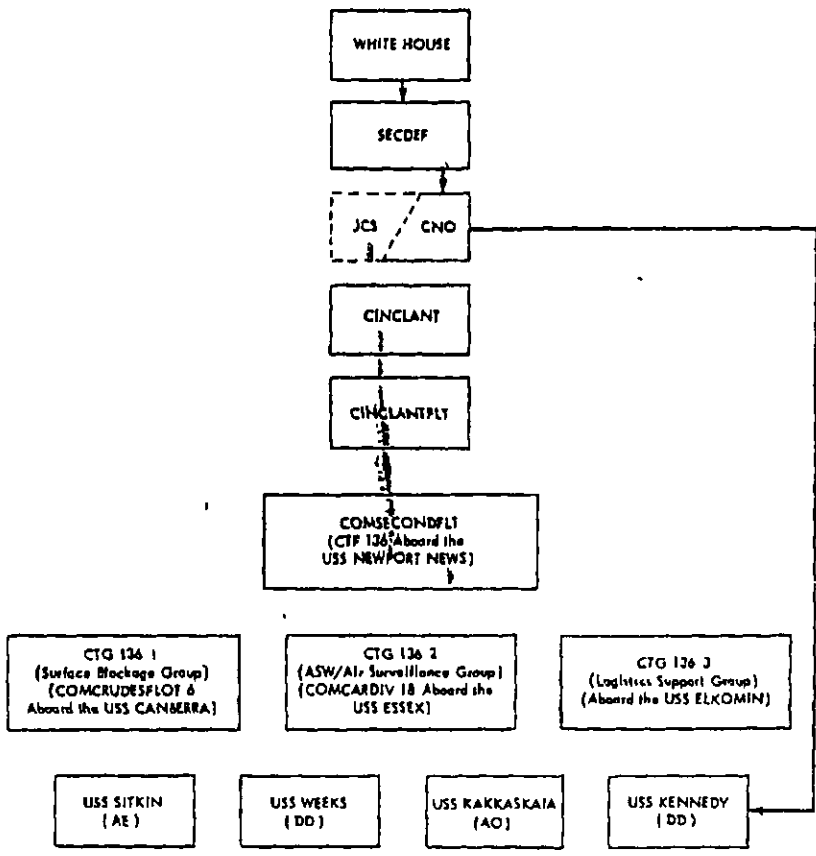

FIGURE 3 Command Arrangements Utilized in Decision Concerning Intercept of MARUCLA, 25-26 October 1962

TOP SECRET

but if on surveillance her topside appearance showed nothing suspected of being prohibited materiel, the PELLIA was not to be trails stopped or boarded.<sup>1</sup>

596. Meanwhile, at the White House, the NSC Executive Committee was in session, attempting to work out a reply to the latest Khrushchev message and to evaluate his promise to the U.N. Secretary General to keep Soviet shipping away from the quarantine area. The Executive Committee was still in session when the unofficial text of a new Khrushchev message, entirely different in tone, was received. Now, the Soviet Premier wanted to exchange withdrawal of his missiles in Cuba for removal of U.S. JUPITERS deployed in Turkey. The President decided to issue a public statement in response to the new, and unacceptable, message and to reply later to Khrushchev's letter of the evening before.<sup>2</sup>

597. During the afternoon, the tension in Washington mounted, although the quarantine area remained relatively quiet. By the time the NSC Executive Committee resumed its session at the White House about 1600 EDT, a U-2 reconnaissance plane had been shot down over Cuba, and two low-level reconnaissance aircraft carrying out additional surveillance of the island had been fired upon. The Executive Committee discussed additional steps which might be taken the following day, including alternatives ranging from ordering the execution of CPLAN 312 to mobilizing U.S. merchant ships and adding POL to the list of prohibited materiel.

598. Despite the signs of stiffening response to the course of action being followed by the U.S., the President approved a reply to Mr. Khrushchev's letter of the previous evening. The President's letter said, in essence, that if the Soviet Premier's remarks had been interpreted correctly, he had indirectly offered to remove his

<sup>1</sup>CNO Flag Plot Log, TOP SECRET.

<sup>2</sup>"Chronology of the Cuban Crisis...", op.cit., p. 14.

TOP SECRET

~~TOP SECRET~~

TOP SECRET

MREB's and IRBM's from Cuba. If this interpretation were correct, the President welcomed the Soviet leader's decision.<sup>1</sup>

599. Shortly after this reply had been dispatched to Moscow, the State Department received a copy of a communication from Premier Castro to the U.N. Secretary General. Castro flatly rejected the Secretary General's earlier proposal that the missile bases be dismantled. In addition, Castro demanded an immediate lifting of the naval quarantine.<sup>2</sup>

600. About 1000 EST on the next day (28 October), Radio Moscow began to broadcast another message to the President from Premier Khrushchev. The full text, as broadcast, was available for the 1100 meeting of the NSC Executive Committee. The official text, delivered to the American Embassy in Moscow only ten minutes after the start of the broadcast, had not yet been received in Washington. In his message, Khrushchev reported that he had ordered the dismantling and return to the USSR, under U.N. supervision, of the missiles in Cuba. A reply to Mr. Khrushchev was discussed, approved, sent and released before the official text was received.

601. About an hour later, the JCS invited the attention of Unified and Specified Commanders to the latest Soviet proposal, but warned that it might be insincere and a ploy designed to gain time. The CINCS were cautioned not to relax alert procedures. Nevertheless until subsequent events could prove whether or not Khrushchev's offer was sincere, it was considered desirable to avoid any provocative actions at the quarantine line. The JCS therefore transmitted to CINCLANT a message drafted by the CNO instructing that no forceful action was to be taken and no ships were to be boarded until receipt of further orders. Intercepted ships were to be challenged

<sup>1</sup>"Chronology of the Cuban Crisis...", op.cit., pp. 15-16.

<sup>2</sup>Ibid.

<sup>3</sup>"Chronology of the Cuban Crisis...", op.cit., p. 16.

<sup>4</sup>JCS Message 7065, to CINCLANT 30 11., TOP SECRET.

TOP SECRET

22 -

~~TOP SECRET~~

~~TOP SECRET~~

TOP SECRET

by visual means only. Should any difficulties be encountered, these were to be reported immediately to the JCS and the CNO before any further action was taken.<sup>1</sup> About an hour later, the identical message was readdressed to provide for information copies to CINCARLANT, CINCAFLANT, CINCONAD, CINGCSAC, and the JAGES.<sup>2</sup> Upon instructions from the Secretary of Defense, the JCS also directed that CINCLANT was to maintain a sharp lookout for ALPHA 66 forces and to prevent this Cuban exile group from undertaking any harassment operations against Cuba at this time.<sup>3</sup>

602. Prior to the issuance of these new instructions, early on the morning of the 28th, CINCLANTFLT had directed the quarantine task force commander to intercept the Russian cargo ship BELOVODSK during the early forenoon on Monday 29 October. The ship was to be trailed, but not stopped or boarded unless so directed. Two destroyers from the quarantine task force continued to trail the GROZNY. By 0555 EST, the GROZNY was dead in the water and the two destroyers holding it under surveillance were remaining about 20 miles to the north. Two DD's were en route to intercept the Greek ship MARITSA.<sup>4</sup> Later in the day, the MARITSA and the PELLA were cleared through the quarantine line. Two destroyers continued to keep the GROZNY under surveillance.

603. To take advantage of the opportunity presented by the temporary lull in operations, CINCLANT proposed to the JCS that the quarantine line be reoriented in order to utilize available forces more economically and to concentrate on intercepting ships using the most likely routes to Cuba. He envisaged a new line, composed of [seven] stations, extending from 90 miles north of the Grand Bahamas to the northeast entrance to the Mona Passage. An [eighth]

<sup>1</sup>JCS Message 7069 to CINCLANT, DTG 281720Z October 1962, UNCLASSIFIED.

<sup>2</sup>JCS Message 7071, DTG 281812Z October 1962, UNCLASSIFIED.

<sup>3</sup>JCS Message 7075 to CINCLANT, DTG 282224Z October, SECRET.

<sup>4</sup>J-3 briefing for CJCS, 280800R October, 1962, TOP SECRET.

TOP SECRET

- 227 -

~~TOP SECRET~~

~~TOP SECRET~~

TOP SECRET

station, manned by a hunter-killer group, would be located to the northeast of this line.<sup>1</sup> The JCS, through the CNO as its representative for quarantine operations, approved CINCLANT's proposal promptly.<sup>2</sup> TF 136 now was responsible for carrying out intercepts in a circular area with a 500-n.mi. radius centered on Cape Maysi. The Secretary of Defense had directed this expansion of the intercept area primarily in order to permit the ships in the task force more freedom of action to follow up contacts. Reducing the number of quarantine stations would free more ships for patrol and would make it more difficult for incoming Soviet ships to avoid transiting areas near known quarantine stations, as they had done previously. The quarantine line was reoriented on 30 October.<sup>3</sup>

504. The same day, beginning first light, the quarantine was lifted temporarily on the instructions of the President at the request of the U.N. Secretary General. After Khrushchev had offered to dismantle and return the missiles in Cuba to the USSR, Castro had objected vigorously to any U.N. inspection. The Secretary General had accepted Castro's invitation to go to Havana to try to work out a solution.

505. Despite the temporary lifting of the quarantine, surface surveillance of the GROZNYI and the BELOVODSK was continued. The two Russian ships were tracked by radar, with the ships accomplishing the surveillance remaining out of visual range of the Soviet vessels at the direction of CINCLANTFLT.<sup>4</sup>

506. Once it had become apparent that the Secretary General's attempt to negotiate a settlement of the Cuban crisis during his visit to Havana would not be successful, the JCS, late in the

<sup>1</sup> CINCLANT message DTG 280420Z October 1962, to JCS, SECRET.

<sup>2</sup> JCS Message 7064 to CINCLANT, DTG 281545Z October, 1962 UNCLASSIFIED. The message was drafted within OPNAV.

<sup>3</sup> COMSECONDFLT OP Order 1-62 to CTF 136, DTG 300055Z October, TOP SECRET.

<sup>4</sup> CINCLANTFLT message, DTG 301858Z October, 1962 to COMSECONDFLT, TOP SECRET.

TOP SECRET

~~TOP SECRET~~

TOP SECRET

evening of 31 October Washington time, instructed CINCLANT to re-institute the quarantine operations beginning at daybreak on 1 November. However, due to the uncertain political situation, CINCLANT was directed to challenge or hail and trail ships entering the quarantine area only. No vessels were to be boarded or searched and no force was to be used except in self-defense unless prior authorization from the CNO, the JCS, or higher authority first had been obtained. CINCLANT was instructed to continue to report quickly all incidents.<sup>1</sup>

607. Shortly after midnight on 1 November, Washington time, the only surface ships being trailed were the BELOVODSK and the GROZNYI. Preparations had been made for an aerial search commencing first light to locate the Soviet merchant ship MIR, with which contact had been lost during the two-day suspension of quarantine operations.

608. CINCLANT reported to the JCS the location of ships of primary interest heading for Cuba and located west of longitude 50° as of 011058Z November. These vessels were: the Russian ships GROZNYI, BELOVODSK, MIR, and KARL MARX; the Swedish ships PIRGIT and GOTTERN; the Cuban ships CAMAGUEY and SIERRA MAESTRA; the Czech ship KLADNO; the Italian ship ASPROMONTE; the East German ship THEO KORNER; and the Turkish merchant ship ESCREF. CINCLANT reminded the JCS that his present instructions prevented stopping or boarding any of the above ships unless authorized by higher authority. Therefore, CINCLANT recommended that they be permitted to proceed after identification.<sup>2</sup>

609. Most, if not all, of the four Russian ships had been dead in the water for some time, presumably awaiting direct instructions

<sup>1</sup>JCS Message 7146 to CINCLANT DTG 010046Z November, to CINCLANT, SECRET, confirming earlier telephone instructions from Admiral Anderson (CNO) to Vice Admiral Beakle, for relay to Admiral Dennison (CINCLANT).

<sup>2</sup>CINCLANT message to JCS, DTG 011058Z November, 1962 TOP SECRET.

TOP SECRET

- 295 -



TOP SECRET

~~TOP SECRET~~

from Moscow. In fact, ever since the morning of 28 October, when the White House first received Khrushchev's message announcing that he had ordered the Soviet offensive missile bases in Cuba dismantled and the missiles returned to the USSR, all Russian merchant ships within TF 136's area of operations had been behaving erratically. Apparently, the Soviet Union was experiencing certain command and control problems of its own, and the ships' masters were awaiting explicit orders. In addition, some Soviet ships seemed to be having mechanical difficulties during this period. Others may have been deliberately attempting tactical evasion in order to avoid contact with the TF 136 force and with other U.S. surveillance-intercept elements. Whatever the case, throughout November 1 and 2, the four Soviet ships then in the quarantine area continued to alternate between proceeding on course and stopping for several hours. For example, the BELOVODSK was reported under way again as of 1827 Washington time on 1 November.<sup>1</sup> Later, during the night, the GROZNYI also got under way, but by that time the BELOVODSK was once again dead in the water.<sup>2</sup>

610. On 2 November, CINCLANTFLT directed the quarantine commander to continue present actions, with at least one destroyer assigned to trail each of four Soviet ships -- the tankers MIR, KARL MARX, and GROZNYI and the merchant ship BELOVODSK -- until otherwise directed.<sup>3</sup> The GROZNYI once more was dead in the water, with one destroyer maintaining surveillance. The BELOVODSK again was under way, headed for Cuba, with the destroyers trailing. The quarantine task force commander had directed that air surveillance only be maintained over the KARL MARX. It was anticipated that a destroyer escort would be provided for this Soviet tanker when it approached closer to the areas in which DD's not already assigned to trail duty were operating.<sup>4</sup>

<sup>1</sup>CNO Flag Plot Log, TOP SECRET.

<sup>2</sup>CTF 136 message to CINCLANTFLT, 020236Z November 1962, TOP SECRET. CTF 136 message to CINCLANTFLT, 020312Z November 1962, TOP SECRET.

<sup>3</sup>CNO Flag Plot Log, TOP SECRET.

<sup>4</sup>Ibid.

TOP SECRET

- 230 -

~~TOP SECRET~~

~~TOP SECRET~~

TOP SECRET

targets, had reversed their course and returned to the USSR. Therefore, inspection had been accomplished primarily by aerial reconnaissance and visual observation. Only one vessel, the Lebanese freighter MARUCLA, known to be under Soviet charter, had been stopped and boarded. Soviet ships that did enter the quarantine area had deliberately attempted to avoid contact with elements of TF 136, necessitating more search activities than originally had been anticipated. In addition, those few Soviet ships in the quarantine area during the few days immediately following Khrushchev's missile withdrawal announcement of 28 October apparently were having considerable difficulty in obtaining instructions. The fact that they would remain dead in the water, then get underway for Cuba, then stop again, seems to have reflected the uncertainty of the ships' masters as to whether to turn back or to proceed to Cuba. The second phase of TF 136's role in furnishing military support to help implement political decisions was about to begin.

614. However, before examining the role TF 136 played in verifying the withdrawal of the Soviet missiles from Cuba, it is necessary first to discuss three other issues related to the conduct of the naval quarantine. In retrospect, all three turned out to be of far less significance to the actual implementation of the quarantine concept than the policy planners had anticipated. Nevertheless, during the crisis itself they did require the attention of the JCS, of CINCLANT and certain other Unified Commanders, and of non-military elements of the national decision-making complex. These topics are:

- a. Latin American participation in the quarantine operation
- b. Decisions on the use of the Panama Canal to support enforcement of the quarantine; and
- c. Planning for a potential air quarantine.

TOP SECRET

- 232 -

~~TOP SECRET~~

TOP SECRET

515. The first two issues already have been discussed -- in a somewhat different context -- in the section of this study dealing with inter-Allied coordination during the crisis.<sup>1</sup> Therefore, emphasis will be placed here on examining those aspects of these two problems which were directly relevant to enforcement of the quarantine.

LATIN AMERICAN PARTICIPATION IN THE QUARANTINE

516. Very early in the crisis, as soon as a limited naval blockade began to be considered as a potential course of action, the political desirability of utilizing naval forces from Latin America to assist in its implementation was recognized by the national policy planners. Militarily, however, the concept could introduce more problems than it solved. As has been pointed out already in Chapter III of this Enclosure, the JCS and other military planners originally assumed that when the U.S. implemented whatever military course of action that might be decided upon, many Latin American nations would be plagued with Communist-inspired internal disorder. Others, the JCS felt, undoubtedly would seek to remain aloof or even to oppose the U.S. response politically. Considerable attention was being given to the problem of furnishing riot control assistance to Latin American nations through CINCARIB. Moreover, communications facilities with certain Latin American nations were inadequate. An interdepartmental Executive Committee for Communications under the NSC was studying this entire problem at the time the crisis broke.<sup>2</sup>

517. [In addition, the JCS estimated that only six Latin American nations had ships suitable for use in a naval quarantine, and that even these nations were capable of no more than nominal participation. Furthermore, while the JCS considered that nominal ]

L-1A5

See Chapter IV of this Enclosure.

In conjunction with insuring readiness for various crisis-connected contingencies, by 28 October arrangements had been made for CINCARIB to utilize CIA facilities in certain Latin American nations to handle cipher traffic as events required. (JCS Message 074 to CINCARIB, DTG 232156Z October, 1962 SECRET.) ]

B/A4

TOP SECRET

20

TOP SECRET

~~TOP SECRET~~

American offers of assistance were flatly refused, the negative political repercussions might be highly significant. Therefore, all problems relating to the question of Latin American cooperation in quarantine operations were, throughout the crisis, closely coordinated between the JCS, the State Department, the CNO, and the White House.

620. Despite the fact that the OAS gave unanimous endorsement, on 23 October, to the announced U.S. course of action, offers of actual assistance were slow in materializing. As the JCS had estimated, most nations lacked the operational capability required for active participation in quarantine operations. In addition, although the military Chiefs of Staff of some Latin American nations were anxious to furnish assistance, the process of achieving the required approval of their own national political superiors was slowed down by the procedural formalities prescribed by their national laws.

621. Utilizing JCS policy guidance to provide for close cooperation with the forces of friendly nations which might offer to assist in enforcing the quarantine, CINCLANT, quite early in the crisis, began to develop plans for a surface quarantine force for the southern approaches to Cuba. Whatever South American forces were made available were to serve in this force, which would be designated TF 137 and commanded by CONSOLANT. TF 137, when established, would remain under the direct operational control of CINCLANT, and only ships designated by CINCLANT would be intercepted. This CINCLANT plan was transmitted to the JCS for approval on 26 October.

622. Even prior to the crisis, the negative views of the JCS on the concept of utilizing an international command under the aegis of the OAS for Cuba contingency operations had been made known to

TOP SECRET

- 235 -

~~TOP SECRET~~

TOP SECRET

~~TOP SECRET~~

624. The other purposes underlying the Secretary of Defense directive were unrelated to the problem of Latin American participation. The second circular area designated by the Secretary of Defense corresponded to, and lengthened, the original intercept arc along which the principal quarantine force, TF 136, already was operating. This expansion of the intercept area to encompass a circle with a 500-n.mi. radius centered at Cape Maysi was intended to permit TF 136 greater freedom of action in carrying out the quarantine operations. The Secretary of Defense objected to the limitations imposed on trail and interception of contacts which, in his opinion, had existed earlier because the quarantine line on which TF 136 destroyers were assigned patrol stations was of limited length. The third purpose of the Secretary of Defense directive was to increase psychological and political pressures on the Soviets by stressing that Cuba now was completely encircled by the U.S. naval quarantine. This, of course, was a political rather than a military consideration, since it was operationally impossible for TF 136 effectively to patrol the entire area for which it now was responsible. This Secretary of Defense directive was transmitted to CINCLANT by the JCS for immediate implementation, insofar as it affected TF 136, and for the guidance of TF 137 if and when the latter force became operational.<sup>1</sup>

625. By 31 October, the JCS had approved CINCLANT's OPLAN for TF 137, and CINCLANT had designated COMSOLANT (U.S. Commander, South Atlantic) as the commander of this "paper" Latin American/U.S. Combined Task Force.<sup>2</sup>

626. COMSOLANT utilized to advantage the time which elapsed between his formal designation as Commander, TF 137, and the arrival of Latin American ships ready for sea duty. During this

<sup>1</sup>JCS message 7050, DTG 272012Z October 1962 CONFIDENTIAL.

<sup>2</sup>JCS SITREP 9-62 as of 310500Z October, 1962 page 6; transmitted as JCS message 7130, DTG 310900Z October 1962, TOP SECRET.

TOP SECRET

- 237 -

~~TOP SECRET~~

TOP SECRET

period, he augmented his normally small staff and improved communications facilities at his headquarters. [There was a requirement for U.S. Communications Liaison Teams to serve aboard whatever Latin American ships might report to his OPCON, and only a limited number of specialists with the required cryptographic and linguistic abilities were on active duty in the U.S. Navy. Through temporary reassignment of personnel with the necessary combination of talents from duty at posts as far away as Rota, Spain, a sufficient number of Communications Liaison Teams were formed. These teams later carried their own crypto systems aboard the Latin American ships which ultimately participated in TF 137 operations, and communications between the ships on patrol and COMSOLANT's headquarters were satisfactory.]

627. By 1 November, the Dominican Republic had reported two frigates to the operational control of COMSOLANT for planning purposes. These were under repair, since evaporator failures limited their immediate operational usefulness. Two Venezuelan destroyers also reported to the OPCON of COMSOLANT for planning purposes on the same day; these were supposed to be ready for sea duty by 2 November. On 8 November, two Argentine DD's reported to the OPCON of COMSOLANT ready for duty.<sup>2</sup> The only other Latin American nation formally offering naval units was Guatemala, which on 18 November promised a frigate. It was to be ready for sea 7 December.<sup>3</sup> Meantime, the quarantine had been lifted, so the vessel never participated.

628. It was not until 12 November that the ships assigned to TF 137 departed Trinidad to begin patrol duty at sea. Before operations could commence, it had been necessary to translate into

<sup>1</sup>LANTCOM, Headquarters of the Commander in-Chief. "CINCLANT Historical Account of Cuban Crisis, 1962 (U)," 29 April 1963, TOP SECRET, pages 127-131.

<sup>2</sup>JCS SITREP of 010500Z November, transmitted as JCS Message 7147, DTG 010944Z November, TOP SECRET; "Summary of Latin American Offers of Forces and Facilities (U)," USN OP-63 Memo 00395-52, 12 November 1962, SECRET.

<sup>3</sup>CINCLANT message DTG 182338Z November 1962 to COMSOLANT, CONFIDENTIAL.

TOP SECRET

Spanish COMSOLANT's OPORD 9-62, which spelled out the operational concepts which were to govern TF 137's activities. This was accomplished at Trinidad with the assistance of officers assigned to the Argentine ships which had reported to COMSOLANT's OPCON on 8 November.<sup>1</sup>

629. Between the time it began operations and the lifting of the quarantine, TF 137 reported a total of 153 contacts.<sup>2</sup> However, ships of interest en route to Cuba were not utilizing the southern approach which TF 137 was responsible for patrolling. By the time the ships in the task force had reached their stations, the crisis already was drawing to a close. All the Soviet merchant ships returning dismantled missiles to the USSR had departed Cuba and had been inspected. Therefore, the only actual intercept which CINCLANT directed CTF 137 to carry out involved the ANGELOS. On 17 November, CINCLANT directed that the ANGELOS be intercepted, photographed, and visually observed. If no prohibited materiel was in evidence, the trail of the ship was to be discontinued.<sup>3</sup> The ANGELOS was intercepted the same day. It cooperated fully, reported its cargo to the intercepting TF 137 ship, and was cleared to proceed on course.<sup>4</sup> Three days later, the quarantine was lifted. CINCLANT directed COMSOLANT to cease TF 137 operations and to consider the desirability of carrying out combined maneuvers before returning the Latin American vessels to their respective national OPCON's.<sup>5</sup>

630. Since events had unfolded as they did, the role of TF 137 during the enforcement of the quarantine had proved to be of little operational significance. The creation of TF 137 did achieve, to

<sup>1</sup>LANTCOM, Headquarters of the Commander-in-Chief, "CINCLANT Historical Account of the Cuban Crisis, 1962 (U)," 29 April 1963, TOP SECRET, p. 128.

<sup>2</sup>Ibid., p. 129.

<sup>3</sup>CINCLANT message DTG 170516Z November 1962 to Commander, TF 137, information copies to CTF 136, CNO JCS and CINCLANTFLT, CONFIDENTIAL

<sup>4</sup>CTF 137 message DTG 171430Z November, 1962, to CINCLANT, information copies to JCS, CNO, JACE's, et al., CONFIDENTIAL.

<sup>5</sup>CNO Flag Plot Log, TOP SECRET.

TOP SECRET

~~TOP SECRET~~

some extent, the desired political purpose, even though the widespread Latin American participation hoped for by the President never materialized. [Most important of all, the existence of TF 137 did not jeopardize the operational efficiency of the principal quarantine force, TF 136. (Before the command arrangements which were to be applied at the tactical level had been developed by CINCLANT, this possibility had engendered considerable concern among the military planners.) Similarly, the difficulties for command and control which might have stemmed from demands for the creation of an international command under the OAS, which the JCS felt must be avoided at all costs, never became a serious problem. Nor did the saturation of communications facilities at his Trinidad headquarters which COMSOLANT had thought might occur as a consequence of the existence of TF 137 ever take place.]

[Sufficient U.S. personnel and cryptographic equipment to meet the requirement for Communications Liaison Teams aboard the few Latin American ships which participated were made available to COMSOLANT. (Had Latin American participation been more widespread, this conceivably could have become a serious problem.)]

631. The requirement closely to coordinate all policy guidance concerning the role of Latin American forces in quarantine operations between the State Department, the White House, the OSD, the JCS, and the CNO did add one more item to the already heavy agenda of policy planners. However, this did not seem to have any serious negative effects on the decision-making process, which obviously was dealing simultaneously with a complex of far more important issues. In addition, message traffic was increased by the decision to furnish detailed policy guidance from the highest levels to the military attaches and State Department personnel involved in the complicated negotiations with Latin American countries which were conducted as a follow-up to all formal and

<sup>1</sup> COMSOLANT message DTG 051932Z November 1960 to CINCLANT, requesting top level Navy support for his efforts to improve communications facilities, TOP SECRET.

TOP SECRET

- 240 -

~~TOP SECRET~~



TOP SECRET

~~TOP SECRET~~ E.

informal offers of assistance. However, (despite the shortage of secure communications facilities linking Washington with field personnel in Latin American states,) this analysis has uncovered no serious communications saturation problems which can be attributed primarily to the increase in message traffic stemming from this aspect of crisis-related activity.

632. Insofar as Latin American participation in the quarantine operations was concerned, then, the necessary delicate balance [between political and military desiderata,] which were diametrically opposite, was successfully maintained. However, if the nations of Latin America had designated a larger number of their ships to participate, far greater command and control problems than the few minor ones actually experienced probably would have arisen.

K. USE OF THE PANAMA CANAL TO SUPPORT ENFORCEMENT OF THE QUARANTINE

633. Soon after CINCLANT had received from the JCS the initial rules of engagement and virtual OPLAN for the quarantine, he proposed to the JCS that the rules of engagement be modified to permit supplementary use of the Panama Canal in the conduct of quarantine operations. CINCLANT suggested that CINCARIB be directed to assume responsibility for searching suspected ships transiting the Canal and for developing measures to prevent the transit of ships found to be carrying prohibited materiel.<sup>1</sup> Ultimately, it was decided that the political disadvantages of prohibiting ships carrying forbidden materiel from transiting the Canal would outweigh the operational advantages, which were in any event somewhat dubious, given CINCARIB's other potential missions and limited forces.<sup>2</sup>

634. On 26 October, therefore, the JCS reversed an earlier acceptance of CINCLANT's suggestion and instructed CINCLANT and

<sup>1</sup> CINCLANT message to JCS, DTG 222234Z October, 1962, TOP SECRET.

<sup>2</sup> The political aspects of the problems raised by CINCLANT's proposal to use the Canal Zone in support of quarantine operations have been discussed in more detail in Chapter IV of this Enclosure.

TOP SECRET

- 241 -

~~TOP SECRET~~

TOP SECRET

~~TOP SECRET~~

CINCARIB that enforcement measures for carrying out the quarantine were not to be taken in the Canal Zone. Inspection of cargo, as provided in the rules of engagement spelled out in previous JCS messages for the quarantine force itself, was to be undertaken at the Canal Zone. However, only ships designated by CINCLANT for inspection at the Canal were to be interfered with. Even if inspection was directed, ships were not to be delayed in transiting the Canal merely because prohibited materiel had been discovered aboard. Unless such materiel threatened the security of the Canal Zone, they were to be permitted to proceed. If security was threatened, the procedures contained in a joint State/Defense Department Instruction dated May 10, 1957, concerning transit of the Panama Canal by Sino-Soviet Bloc vessels, were to be followed. When inspections were carried out at the request of CINCLANT, he was to be informed of the results. If prohibited materiel was found aboard such ships, CINCARIB was to maintain air surveillance over these vessels upon their departure from the Canal Zone. This surveillance was to continue until the vessels were beyond the range of CINCARIB's surveillance aircraft or until CINCLANT accepted responsibility for further action.<sup>1</sup>

635. On 28 October, CINCLANT designated the ship EMELYAU PUGACHEV for inspection upon its arrival to transit the Panama Canal.<sup>2</sup> The ship was not scheduled to arrive at the Canal until about 3 November. At 1330Z on 3 November, the inspection requested by CINCLANT was carried out. The ship carried canned fish, fish oils and lumber; no prohibited cargo was discovered. It was permitted to proceed to Havana, ETA 7 November.<sup>3</sup>

636. CINCLANT designated no further vessels for inspection by CINCARIB. None of the ships carrying the dismantled missile back

<sup>1</sup>JCS Message 7002 to CINCLANT and CINCARIB, DTG 261217Z October 1957. SECRET. Information to Governor, Canal Zone, CMO, Service Chiefs, etc

<sup>2</sup>"OPNAV 24-Hour Resume of Events, 2800000 to 2900000Z October," 30 October 1967. TOP SECRET.

<sup>3</sup>CNO Flag Plot Log, TOP SECRET.

TOP SECRET

- 242 -

~~TOP SECRET~~

TOP SECRET

~~TOP SECRET~~

to the USSR utilized a route requiring transit of the Panama Canal, and throughout the quarantine most other shipping of interest also was using other routes. Therefore, as the crisis drew to a close, the nature of the Soviet response had been such that the decision to minimize utilization of the Canal Zone for inspection and surveillance of Cuban-bound ships before they had entered the designated intercept area had caused no operational difficulties. The potential negative political repercussions which undoubtedly would have occurred if the JCS had not withdrawn its initial approval of CINCLANT's original suggestion had been successfully avoided.

L. THE ABORTIVE PLAN FOR AN AIR QUARANTINE

637. Soon after the onset of the crisis, one of the alternative courses of action under active consideration was the imposition of an air quarantine, designed to prevent the introduction into Cuba of prohibited materiel by airlift as well as by sealift. As has been pointed out already, the original guidance transmitted by the JCS to CINCLANT directed that he develop plans for an air quarantine of Cuba as well as for a naval quarantine.<sup>1</sup> The rules of engagement, as transmitted to CINCLANT, contained fairly detailed instructions concerning interception of aircraft.

638. CINCLANT had developed a plan for an air blockade of Cuba earlier, in conjunction with planning related to Soviet farming of tensions over Berlin. Although some modifications were required to ensure that this plan was tailored to the new JCS guidance, it did furnish a basis for developing an OPLAN for a limited air quarantine of Cuba. By 23 October, this plan, CINCLANT OPLAN 308-62, was forwarded to the JCS for approval.<sup>2</sup>

<sup>1</sup>JCS Message 6949 to CINCLANT, DTG 221111Z October 1962 TOP SECRET.

<sup>2</sup>CINCLANT message to JCS, DTG 231904Z October 1962 SECRET.

TOP SECRET

- 243 -

~~TOP SECRET~~

TOP SECRET

~~TOP SECRET~~

639. Meanwhile, planning for a limited air quarantine of Cuba was going on within the JCS itself. The Deputy Secretary of Defense had requested the views of the JCS on this matter on 19 October, and several papers had been developed within J-3 for JCS consideration. Hence, planning for the air quarantine, in contrast to planning for the naval quarantine, was accomplished by the JCS organization in accordance with standard procedures. (The details of planning for the naval quarantine, it will be recalled, were carried out within the office of the CNO.)

640. Since the original JCS policy guidance to CINCLANT had included references to an air as well as to a sea quarantine, some confusion apparently arose as to whether or not the JCS order to implement the naval quarantine, issued on 23 October, was intended to apply as well to the quarantine of aircraft. CINCONAD requested clarification. On 24 October, the JCS explicitly informed CINCLANT and CINCONAD that its order of the previous day directing implementation of the quarantine did not apply to the quarantine of aircraft. CINCLANT would be advised if implementation of an air quarantine was desired.<sup>1</sup>

641. Meanwhile, on the 23rd, CINCLANT had released his OPLAN 308-62 (Limited Air Blockade) for planning purposes only. Two days later, he amended the command arrangements in the original OPLAN to provide explicitly that no aircraft not designated by CINCLANT was to be intercepted or interfered with. CINCLANT would designate each aircraft suspected of carrying prohibited material and would, in each instance, state explicitly what kind of action, if any, was required.<sup>2</sup>

642. On 27 October, CINCLANT promulgated his OP Order 49-62 concerning the limited air quarantine of Cuba. The OP order was

<sup>1</sup>JCS Message 6945, DTG 241823Z October, 1962 SECRET.

<sup>2</sup>CINCLANT message, DTG 231904Z October 1962 to JCS and LANTCOM Component Commanders, SECRET; CINCLANT message, DTG 251705Z October 1962 to JCS and LANTCOM Component Commanders, SECRET.

TOP SECRET

~~TOP SECRET~~

effective for planning upon receipt and for execution upon direction. The command arrangements outlined by CINCLANT were as follows:

a. The two execution commanders would be the commander of TF 84 (COMCARIBSEAFRON) and the commander of TF 135 (COMCARDIV 2).

b. COMCARIBSEAFRON would be responsible for the limited air quarantine in the area east of Cuba, utilizing the forces available to him and whatever Puerto Rican National Guard Forces were made available by COMANTDEFCON.

c. COMCARDIV 2 would be responsible for the limited air quarantine in the area south and east of Cuba with the forces assigned to him.

d. CINCONAD would assist within the vicinity of the coastal ADIZ or within the range of his air defense systems.<sup>1</sup>

Later, at the direction of the JCS, details concerning additional support from CINCSAC and command liaison between CINCSAC and CINCLANT were added.<sup>2</sup>

643. Meanwhile, the J-3 plan and recommendations concerning an air quarantine of Cuba had gone "green". At their meeting of 27 October, the JCS decided to forward the plan to the Secretary of Defense along with other recommendations related to the air quarantine.<sup>3</sup> The plan was forwarded on 29 October. The JCS OPLAN also was transmitted the same day (29 October) to CINCLANT, CINCSAC and CINCONAD for their information. The same message approved, for planning purposes, CINCLANT OPLAN 305-62, as modified by the JCS plan.<sup>4</sup> The JCS concept of operations

<sup>1</sup>"OPNAV 24-Hour Resume of Events, 270000-280000Q October," TOP SECRET.

<sup>2</sup>SAC OPOD 100-63, effective for planning upon receipt and for implementation if directed by Headquarters SAC. Transmitted as SAC message to various subordinate commands, information JCS, CINCONAD, CINCLANT, et al., DTG 072230Z November, TOP SECRET. (AF In log numbers for the message, which was transmitted in four sections, are AF In 15509, 15510, 15,16, [sic], and 15515 [sic] respectively, all dated 8 November 1962.)

<sup>3</sup>JCS 2304/77, October 1962, pages 554 to 564 inclusive, TOP SECRET.

<sup>4</sup>JCS Message 7080, DTG 291710Z October 1962 TOP SECRET.

TOP SECRET

~~TOP SECRET~~

envisaged that, as a first step, all possible diplomatic pressure should be exerted in order to prevent aircraft transporting Soviet Bloc materiel from being allowed to use the customary en route refueling bases on non-Communist territory. In addition, the JCS plan provided that CINCONAD and CINCOSAC were to assist in enforcing the quarantine along the route from Gander to Cuba. They also would assist CINCLANT in enforcing the quarantine along the southern transatlantic and Caribbean air routes. The JCS memorandum of transmittal pointed out to the Secretary of Defense that, in the view of the JCS, the Presidential Proclamation of 23 October clearly authorized an air quarantine of Cuba if the Secretary of Defense decided that it was necessary.<sup>1</sup>

644. Soon after the crisis arose, the State Department, as part of its efforts to gain the participation of other nations in the U.S. response to the Soviet missile build-up, had begun to take steps to encourage Canada, the U.K., and other nations to deny landing rights to Soviet aircraft transiting to Cuba. This effort was successful. [The resultant administrative harassment was considered by the JCS to be sufficiently effective.]<sup>2) 45</sup>

645. Therefore, no requirement for implementing an air quarantine developed. In fact, the Secretary of Defense did not formally approve the JCS plan until 14 December, after the quarantine had been lifted. Even then, the plan was approved for planning purposes only, and with the rules of engagement modified to provide that authority to order an attack was to be retained by the JCS and was not to be delegated to CINCLANT.<sup>3</sup>

646. In summary, the concept of an air quarantine never was actually applied during the crisis. In sharp contrast to the

<sup>1</sup>JCSM-832-62 to the Secretary of Defense, dated 29 October 1962, TOP SECRET.

<sup>2</sup>JCS Message 7184 to CINCONAD, DTG 021948Z November 1962, SECRET.

<sup>3</sup>JCS 2304/125, 17 December 1962, page 779, TOP SECRET.

TOP SECRET

- 243 -

~~TOP SECRET~~

TOP SECRET

~~TOP SECRET~~

arrangements utilized for planning and implementing the naval quarantine, with the CNO serving as the designated JCS representative, the planning for an air quarantine followed a more conventional pattern. The bulk of the planning was accomplished within the JCS organization itself. Had the Soviet response to the imposition of the naval quarantine been different, and had the USSR decided to mount a massive airlift in defiance of the naval quarantine the U.S. had imposed, plans for such a contingency existed. They could have been implemented promptly.

M. THE ROLE OF TF 136 IN VERIFYING WITHDRAWAL OF SOVIET MISSILES

647. In order to relate the activities of the principal quarantine force -- TF 136 -- to pertinent aspects of the decision-making process during the latter part of the crisis, it is necessary to resume the chronological account which was interrupted to deal with other topics.

648. From 7 November until the crisis was over, TF 136 had a dual mission. Although it continued to enforce the quarantine on the importation of prohibited materiel into Cuba, its principal activities from that date onward were directed towards verifying the withdrawal of the Soviet missiles from Cuba. This additional role for TF 136 had not been anticipated by the policy planners.

649. Even prior to Khrushchev's announcement, on 28 October, that he had ordered the IRBMs and IRBM's in Cuba dismantled and returned to the USSR, negotiations had been going on at the U.N. and elsewhere to establish acceptable arrangements for verification of the withdrawal of the missiles. After Khrushchev's announcement, the JCS increased its efforts to ensure that any verification arrangements agreed to politically also would meet minimum military requirements.<sup>1</sup>

<sup>1</sup>See, e.g., JCS 2304/81, 30 October 1962 pages 602-607, inclusive, SECRET; JCSM-862-62 to the Secretary of Defense, 2 November 1962, SECRET.

TOP SECRET

- 247 -

~~TOP SECRET~~

TOP SECRET

~~TOP SECRET~~

650. All along, U.S. policy planners had intended that verification of the withdrawal was to be accomplished under the aegis of the United Nations. Negotiations still were focusing on achieving this objective when it became apparent that arrangements for U.N. verification might not be completed before the missiles actually were withdrawn. By 3 November, photoreconnaissance of Cuba had indicated that the Soviet offensive missile sites were being dismantled and that the missiles were beginning to be moved towards Cuban ports. Even earlier, on the night of 31 October, the initial move of some missile equipment away from the sites through Havana had been reported. The first evidence that the sites were being dismantled had become available on 1 November.

651. On 4 November, large amounts of associated equipment -- and some missiles -- were photographed at the port of Mariel, where a number of ocean-going Soviet ships were noted in the harbor. In implementing their withdrawal decision, the Soviets apparently had placed top priority on removal of the missiles themselves, since a large mass of missile-associated equipment remained behind after the missiles had been shipped back to the USSR.<sup>1</sup>

652. The first Soviet ships with missiles aboard sailed from Mariel on 5 November. Photoreconnaissance indicated that other missiles were being moved towards the docks at that port. At La Isabela and Casilda, activity related to preparations for loading missiles aboard Soviet ships also was apparent.<sup>2</sup>

653. Meanwhile, the activities of TF 136 had been reduced considerably as a consequence of the CNO's directive of 3 November, which had stipulated that ships within the quarantine area inbound for Cuba were not to be trailed except at the instruction of

<sup>1</sup>DIA, "Removal of MRBM's from Cuba," 13 November 1962, SECRET.

<sup>2</sup>"The Missiles Leave Cuba," ONI Review, December 1962, p. 511, SECRET, NOFORN.

TOP SECRET

- 243 -

~~TOP SECRET~~



TOP SECRET

~~TOP SECRET~~

higher authority. At the highest levels of politico/military decision making, attention had shifted away from the question of enforcing the quarantine; the verification problem had become a more acute immediate issue. CINCLANT took advantage of this lull in operations in the quarantine area to work out an improved means of designating merchant ships which were under surveillance, were being trailed, or otherwise were of interest to the quarantine force. [On 5 November, he suggested the "SCOTCH TAPE" code word numbering system. The proposal was approved by the JCS on 7 November, when CINCLANTFLT was authorized to assign and cancel SCOTCH TAPE numbers as required by developments.<sup>1</sup> Thereafter, until the quarantine was lifted, both outbound missile-bearing ships and incoming merchant vessels -- Soviet and non-Soviet -- were assigned SCOTCH TAPE numbers. This designation system served as a convenient means of tabulating the data required simultaneously to monitor incoming merchant ships and to inspect outbound vessels with missiles aboard. It permitted more precise communications concerning the ships of interest between the various echelons of the command and control structure, particularly at the tactical level.

654. By the time the "SCOTCH TAPE" designation system was adopted the basic points of a bilateral inspection agreement acceptable to both the U.S. and the USSR had been hammered out at the U.N. After intelligence evidence had begun to indicate that the Soviet Union was preparing to withdraw its missiles from Cuba, the U.S. had initiated the attempt to obtain a bilateral agreement, since there seemed to be no immediate prospects for creating an acceptable multilateral U.N.-sponsored inspectorate.]

655. U.S.-Soviet agreement on the inspection issue was achieved in New York on 6 November. The following day, at the request of the Secretary of Defense, the JCS directed CINCLANT to apply the

<sup>1</sup>JCS Message 7266 to CINCLANT, DTG 071557Z November 1962 CONFIDENTIAL.

TOP SECRET

- 249 -

~~TOP SECRET~~

TOP SECRET

~~TOP SECRET~~ E

terms of reference which had been agreed to at the political level, to all future inspections of both outgoing and incoming Soviet ships. The details spelled out in the bilateral agreement included:

- a. Requirements for an exchange of call signs between intercepting and intercepted vessels in order to establish rendezvous;
- b. Authorization for U.S. ships to pass close aboard the outgoing Soviet ships taking missiles back to the USSR in order to photograph them; and
- c. Permission to use helicopters in obtaining close-up photographs.<sup>1</sup>

On the 7th, the JCS also informed CINCLANT that close surveillance and photography of each of the Soviet ships departing Cuban ports with missiles aboard was a matter of high priority. CINCLANT was directed to arrange for rapid delivery of all photos to the JCS Joint Reconnaissance Center for interpretation.<sup>2</sup>

656. Although there had been some uncertainty among U.S. intelligence experts about the number of missiles actually deployed to Cuba, by this time (7 November), the Soviet figure of 42 MRBM's was accepted as probably accurate. Photoreconnaissance had not indicated the presence of any IRBM's in Cuba. These presumably were to have been shipped after the sites that were under construction had been completed. Some may have been aboard the POLTAVA-class ships which turned back to the Soviet Union shortly after the quarantine was imposed.

657. TF 136, along with other elements of LANTCOM and with assistance from SAC and other commands, began to carry out the inspection mission.

<sup>1</sup>JCS Message 7266 to CINCLANT, DTG 071557Z November, 1960 CONFIDENTIAL.

<sup>2</sup>JCS Message 7064 to CINCLANT, DTG 071519Z November 1960 SECRET.

TOP SECRET

- 250 -

~~TOP SECRET~~

TOP SECRET

~~TOP SECRET~~

658. The following day (8 November), a Soviet spokesman at the U.N. announced that:

a. All outbound Soviet ships would follow the same course, i.e., via the Straits of Florida.

b. Nine Soviet ships, the names of which had been given to the U.S., would be carrying all 42 missiles. The missiles themselves would be on deck, covered with canvas.

c. Shipmasters of the nine vessels had been instructed to inform U.S. quarantine forces as to the number of missiles on board. This, the Soviets felt, was adequate.

d. The Soviets had no objection to the U.S. use of helicopters for very close-in photography.

e. If necessary, the canvas covers of the missiles could be removed.

f. There was no need to give the U.S. the call signs of the Soviet missile-bearing ships, since the names had already been revealed.<sup>1</sup>

659. The Soviet spokesman's assertions did not prove to be entirely accurate. Call signs of at least nine of the Soviet outbound vessels were obtained and furnished to CINCLANT. The missiles themselves proved to be carried aboard eight Soviet merchant ships. (The ninth ship carried only associated support equipment.) Outbound Soviet vessels did not always follow the course through the Florida Straits which had been agreed upon, necessitating considerable search activity before a rendezvous could be arranged.<sup>2</sup> However, between 8 and 11 November, all nine ships reported by the Soviets to be carrying missiles had been intercepted, and 42 missiles counted. When intercepting, the U.S. forces followed the instructions of the Secretary of Defense, signaling to the Soviet vessels, "Your government has agreed to uncover missiles. Please do so."<sup>3</sup>

<sup>1</sup>JCS Message 7-23 to CINCLANT, DTG 081501Z November 1962, UNCLASSIFIED.

<sup>2</sup>CNO Flag Plot Log, TOP SECRET.

<sup>3</sup>JCS Message 7306 to CINCLANT, DTG 090000Z November 1962, CONFIDENTIAL.

TOP SECRET

- 251 -

~~TOP SECRET~~

TOP SECRET

~~TOP SECRET~~ L

560. Once a rendezvous had been arranged, the cooperation of the Soviet shipmasters varied. Some removed part of the canvas outer coverings of the missile transporters without even waiting for a request from the intercepting force. Others refused to uncover missiles at all, or removed only a small portion of the outer coverings. In no case was the inner waterproof casing around a missile removed.

561. Shortly after TF 136 had completed its unanticipated role in verifying the withdrawal of the Soviet missiles from Cuba, an additional group of vessels had left Bloc ports and were headed for Cuba. By 13 November, there were 17 such incoming ships. Sixteen were of Soviet registry, and one was an East German vessel. Two of the Soviet ships were estimated to be capable of carrying missiles below deck. These were expected to arrive in the quarantine area on 16 and 17 November.

562. The CNO, in a memorandum to the Secretary of Defense, pointed out that considerable time had elapsed since any Bloc ship inbound to Cuba had been intercepted. He recommended that the following steps be taken:

a. The Yugoslav tanker, IZ, due at the quarantine area on 14 November, be intercepted;

b. Each of the incoming Soviet cargo ships be intercepted, beginning with the ATKARSK, due at the quarantine area on 15 November;

c. Priority be given to ensure the intercept of the two incoming Soviet ships, the OKHOTSK and the ORENBURG, with 72-foot hatches, which were considered capable of carrying missiles in their holds;

d. A public announcement be made that the Norwegian ship TRAJAN, inbound to Cuba, had been intercepted and boarded on 12 November; and

e.  B1-5

Attachment to JCS 2304/100, dated 14 November 1962, pp. 71-673, inclusive, TOP SECRET.

TOP SECRET

- 252 -

~~TOP SECRET~~

663. The CNO's memorandum was discussed and generally concurred with by the JCS on 13 November.<sup>1</sup>

664. Subsequently, CINCLANT was directed to intercept the incoming East German vessel and the various Cuba-bound Soviet vessels as they entered the quarantine area. The procedures of the bilateral agreement on inspection of incoming and outgoing ships were to be followed precisely. On 15 November, the ATKARSK was hailed and photographed by the W. A. LEE. Messages were exchanged and the cargo was declared to be flour, wine, and macaroni. No deck cargo was observed, and the ship was cleared to proceed.<sup>2</sup>

665. On 17 November, the SELLERS intercepted the OKHOTSK. Under the rules of engagement which then were being applied and which had been negotiated at the diplomatic level, the ship could not be boarded. No deck cargo was observed; the ship reported herself en route to Mantanzas with a cargo of 240 tons of steel. The master and crew cooperated fully, and the vessel was cleared to proceed.<sup>3</sup>

666. Before the other incoming ships of interest could be intercepted, the quarantine had ended. On 20 November Castro finally agreed not to interfere with the withdrawal of the IL-28 bombers from Cuba, which he said belonged to the USSR, and not to Cuba. The JCS instructed CINCLANT to lift the quarantine, effective immediately.<sup>4</sup>

667. The following day, CINCLANTFLT dissolved TF 136 and directed units to return to their normal OPCON. One OVA group from TF 135 was directed to remain in operating vicinity of Cuba, and COMASWFORLANT was directed to be prepared to locate and photograph Soviet ships leaving Cuban ports with IL-28 aircraft aboard.<sup>5</sup>

<sup>1</sup> Attachment to JCS 2304/100, dated 14 November 1962, pp. 671-673, inclusive, TOP SECRET.

<sup>2</sup> CNO Flag Plot Log, TOP SECRET.

<sup>3</sup> Ibid.

<sup>4</sup> JCS Message 7475 to CINCLANT, et al., DTG 202314Z November 1962  
TOP SECRET.

<sup>5</sup> CNO Flag Plot Log, TOP SECRET; CINCLANT message DTG 210250Z November, 1962 to CINCLANTFLT TOP SECRET. ~~TOP SECRET~~

TOP SECRET

~~TOP SECRET~~

668. Difficulties over removal of IL-28's were to continue for some time. A Soviet spokesman announced to a U.S. representative at the U.N. on 4 December that 42 IL-28's would be shipped out on December 5, 6, and 7.<sup>1</sup> The first sightings of outbound IL-28's were made on the 6th. The fuselages, crated and uncrated, were on deck, and an accurate count was achieved. Although all IL-28's were not removed at once, the quarantine was deemed to have achieved its purpose and the Cuban crisis had ended. The nature of the Soviet response had been so different from what had been anticipated that no requirement had arisen to apply the elaborate rules of engagement worked out during the critical week of 15 October.

#### N. SUMMARY OBSERVATIONS

669. The principal external influences on military command and control related to naval quarantine operations proved to cluster within two categories. Both in form and in function, command and control had to adapt to requirements imposed by:

a. The decisions and actions of U.S. national (civilian) authority, and

b. The behavior patterns of the principal antagonist - the USSR.

These determined to a large extent what kind of command and control structure emerged and how its processes would operate.

#### The Nature of the Crisis and the Role of the Quarantine in the Total U.S. Response

670. Precrisis planning for a Cuban contingency had been based primarily on the assumption that the principal antagonist would be the Castro regime. After it became apparent that the main confrontation would be between the U.S. and the Soviet Union, the alternative courses of action for dealing with the emergency took

<sup>1</sup>JCS Cuba SITREP 44-62, 050400Z November, TOP SECRET.

TOP SECRET

- 254 -

~~TOP SECRET~~

673. The quarantine operations, then, were pivotal in the overall national strategy for dealing with the crisis. Subsequent decisions regarding all other U.S. moves were dependent upon the interplay of events which followed its imposition. Simultaneously, it was imperative to coordinate the operational activities of the quarantine task force with the U.S.-Soviet political dialogue. At any given point during the crisis, thus, quarantine command and control was subordinate to considerations other than the immediate military operations at hand.

#### Command and Control of Unilateral Quarantine Operations

674. When the original quarantine task force (TF 136) was established by CINCLANT it was assumed that standard command relations would apply. However, even prior to implementation of the naval quarantine, it proved necessary to adjust command and control of TF 136 to the evolving strategy of the national decision-makers. Later, requirements for yet other revisions in command arrangements for TF 136 stemmed primarily from the operational moves of the USSR.

675. Two U.S. developments occurring quite early in the crisis necessitated the initial adjustments. The first was the designation of the Chief of Naval Operations (CNO) as JCS representative for quarantine operations (and defense of Guantanamo as well) the second was the shroud of special security restrictions that was thrown over some intelligence relevant to quarantine operations. A shroud which did not begin to be lifted until after all the principal Soviet targets for initial interception had turned away from Cuba.

676. The decision to designate the CNO to serve as JCS representative for naval quarantine operations, taken on 19 October, precipitated a series of departures from the established institutional patterns of national command and control. They necessitated a partial and temporary modification of the usual intermediary command channels linking the President with LANTCOM forces, which indirectly caused secondary changes in staff organization and procedures.

TOP SECRET

~~TOP SECRET~~

677. Advantages accruing from the designation of the CNO as JCS representative for the quarantine were:

a. Facilitating, during the critical initial week of national decision making, timely coordination between the CNO and CINCLANT -- and their respective staffs -- on operational matters that by their nature were almost exclusively within the purview of a single Service;

b. Freeing the Joint Battle Staff and other elements of the JCS organization to concentrate on preparations for more drastic military action which might become necessary momentarily.

678. The CNO's designation as JCS representative also imposed several requirements for adaptation of existing OJCS structure and processes:

a. Partial alteration of the role of the JCS as a corporate entity -- and the concomitant role of the Joint Staff and OJCS -- in that part of the crisis decision-implementation process which pertained to the quarantine;

b. Transference to OPNAV, and particularly to CNO Flag Plot, of some of the operational and functional responsibilities normally assumed during a crisis by the Joint Battle Staff; and

c. Creation of a liaison group within the JCS organization specifically responsible for ensuring a smooth flow of information on quarantine developments to those echelons within the JCS which needed such information.

679. Within the Operations Directorate of the JCS, certain rearrangements in staff procedures were required, partly as a consequence of the designation of the CNO as JCS representative for quarantine operations and partly because of the imposition of special security restrictions. One important innovation that resulted was the creation within J-3 of a special Blockade (i.e., Quarantine) Group which stood watch around the clock and served as the principal liaison between OPNAV and the JCS on quarantine

TOP SECRET

- 257 -

~~TOP SECRET~~



TOP SECRET

~~TOP SECRET~~

matters throughout the crisis. It was this group which kept the Office of the Chairman, the Director, J-3, and others within the Joint Staff who had a "need to know" informed about quarantine developments. Because of the special security constraints, this Blockade Group had to be set apart from the Joint Battle Staff and functioned outside the NMCC complex. After security restrictions eased, it helped to insure that the flow of quarantine data to the Joint Battle Staff from OPNAV was as complete and timely as possible. Although both the creation of the special J-3 Blockade Group and the designation of the CNO as JCS quarantine representative occasioned some difficulties within the JCS organization at the staff level, these apparently had no significant bearing on the decision-making processes of the JCS as a corporate entity.

680. The first Soviet operational reaction to the quarantine required still further adjustment of quarantine-related command and control. Certain ships assigned to TF 136 had been directed to intercept, at the very hour the quarantine went into effect (1000 EDT on 24 October), two of the sixteen POLTAVA-class Soviet ships steaming towards Cuba. Ships of this class were estimated to be capable of carrying IRBM's and MRBM's in their holds and therefore were the principal targets for interception. When it became apparent, during the night of 23 October, that some of these ships were reversing course, tactical decisions on crucial details of quarantine operations began to be taken at the highest levels in Washington. Such an innovation was considered to be essential until it could be determined whether the quarantine indeed was serving its intended purpose or whether the behavior of the POLTAVA-class ships reflected a new Soviet ploy. Hence, at this juncture, the Secretary of Defense, the CMO, and their deputies turned to the White House for instructions and transmitted the resulting revised directives regarding intercept action directly to individual commanders of ships assigned to the quarantine task force.

TOP SECRET

- 258 -

~~TOP SECRET~~

681. For several days thereafter, tactical decisions concerning details of quarantine operations continued to be taken primarily in Washington. In connection with Soviet tankers, the CNO, through his Executive Officer, again requested White House guidance on the advisability of sending ships to make intercepts. Subsequently, the President also issued policy instructions concerning the interdiction and inspection of non-Bloc ships. Both the clearing of the Soviet tanker BUCHAREST through the quarantine line without it being halted or boarded and the subsequent stopping and boarding of the Lebanese freighter MARUCLA (known to be under Soviet charter) were accomplished through a combination of initial instructions from tactical commanders and final instructions from Washington transmitted directly to the individual commanders of quarantine task force ships concerned.

682. This radical departure from established command channels upset normal information flow, thereby complicating to some extent the staff work in J-3 and other elements of the Joint Staff. However, the line commanders, from CINCLANT through the Task Force 136 Commander, apparently were kept sufficiently informed of developments in Washington to avoid conflict between operations and evolving national policy.]

683. Following the initial flurry of activity in the quarantine area, the remaining number of ships inbound to Cuba suspected of carrying prohibited materiel was limited, and tactical command decisions relating to quarantine operations reverted temporarily to CINCLANT and his subordinate commanders.

684. The second Soviet operational move potentially affecting command and control over the quarantine mission did not occur until 13 November, when it was discovered that an additional group of vessels had left Bloc ports and were headed for Cuba. However, unlike the earlier episode that culminated in the POLTAVA-class

TOP SECRET

~~TOP SECRET~~

ships returning to the USSR, this later development necessitated no drastic adjustments of command and control processes, primarily because intervening developments at the political level had nullified the possibility of boarding and inspecting any ships inbound to Cuba. During this final stage, therefore, command and control was exercised in accordance with customary links between the JCS, CINCLANT, and his subordinate commanders.

Command and Control of Verification Operations

585. Khrushchev's concession of 28 October to withdraw the missiles created an unexpected new operational mission for the quarantine forces. For the next few days the attention of U.S. national decision makers was concentrated on negotiating an acceptable agreement for verifying the withdrawal of Soviet missiles from Cuba. In the interim, while negotiations were in progress, CINCLANT had been instructed by both the JCS and the CNO to avoid stopping or boarding any vessels inbound to Cuba unless so directed by higher authority. During this period activity within the quarantine area was largely confined to visual, photographic, and radar surveillance.

586. Neither the JCS nor the CNO, in his capacity as JCS representative for quarantine operations, had a direct role in the negotiations. The JCS, through recommendations to the Secretary of Defense, attempted to ensure that any inspection and verification arrangements agreed to politically also would meet minimum military requirements. Once a U.S.-Soviet agreement spelling out in some detail the way in which U.S. forces were to inspect ships outbound from Cuba with missiles aboard had been hammered out, the JCS informed CINCLANT of this high-priority verification mission, and directed that it be accomplished with strict adherence to the terms of the bilateral inspection agreement. Since no ships could be boarded, tactical decisions were routine and were taken within LANTCOM.

TOP SECRET

- 260 -

~~TOP SECRET~~

687. Only timely coordination between diplomacy and related military activities -- notably photoreconnaissance of Cuba -- had prevented the Soviets from dragging out the inspection negotiation at the U.N. while removing their missiles from Cuba, thereby precluding any verification whatsoever of missile withdrawal. In carrying out the unanticipated inspection mission, the quarantine task force, reinforced by other LANTCOM elements and assisted by SAC and certain other commands, was able to confirm to the satisfaction of U.S. decision makers the return to the Soviet Union of all 42 MRBM's which intelligence accepted as a "probably accurate" count of the total number deployed to Cuba.

#### Multilateral Quarantine Operations

688. Latin American participation in the quarantine was late and modest. The few ships that were made available became part of TF 137, but several command and control requirements had to be satisfied before they could begin patrol duty at sea. U.S. communications liaison teams with portable cryptographic equipment and bilingual operators had to be organized and assigned to duty aboard each vessel. [Sufficient teams were assembled to provide operationally adequate and secure communications without compromise of U.S. cryptographic security. More foreign ships could have become a serious problem.]

689. Not until 12 November did the TF 137 vessels depart Trinidad and begin patrolling the southern approaches to Cuba. Although as Soviet ships were not using southern routes, CINCLANT directed only one token intercept. The ship designated was not suspected of carrying prohibited cargo and, at CINCLANT's direction, was not boarded.

690. Since widespread Latin American participation in the quarantine operations never eventuated, TF 137 proved to be of little

TOP SECRET

~~TOP SECRET~~

operational significance. Its activation had no appreciable impact on quarantine command and control.

691. Many adjustments had been necessary to adapt the structure and processes of command and control to the exigencies of the quarantine. Despite their great number, the speed with which they were improvised, and their sometimes dramatic divergence from standard arrangements, they resulted in a military command and control capability responsive to the requirements of the national political authority.

TOP SECRET

- 252 -

~~TOP SECRET~~

TOP SECRET

~~TOP SECRET~~

VII. ADJUSTING CONTINGENCY PLANS TO CRISIS REQUIREMENTS

A. THE CUBAN CONTINGENCY PLANS IN RELATION TO THE CRISIS SITUATION

692 Despite its precipitate onset, the Cuban crisis had not caught the U.S. unprepared as far as contingency military plans were concerned. [ There was in existence the so-called "family" of plans that had been evolving over the preceding 18 months. Incomplete and in various stages of refinement, they were, nonetheless, not inappropriate to the kind of situation that had materialized. Patently, they did not cover all of the military aspects of that situation, for it had turned out to be considerably different from the relatively simple localized contingency that had been anticipated by the national decision authorities and on which military planning had been predicated. The introduction of the USSR as a major term in the equation, besides radically altering the political context, exacerbated immeasurably the whole operational environment of any military action toward Cuba. On the one hand, the Soviet factor, with all of its escalation implications, raised the ante of such an undertaking to acute strategic proportions; on the other, it intensified and complicated the immediate tactical circumstances attending operations within Cuba itself. Yet, precisely because of the threatening presence of the offensive capability there, Cuba remained the focus of the crisis, and the contingency plans thus were central to the crucial issue around which the crisis revolved ]

693. Indeed the planning retained essentially the same basic conceptual approach as before the crisis: two kinds of military courses of action against Cuba were still being planned -- air-strike operations and invasion operations. The main

TOP SECRET

- 253 -

~~TOP SECRET~~

~~TOP SECRET~~

TOP SECRET

adjustments that had to be made were more in degree than in kind. But plans for such operations could never crystalize on a set of fixed reference points and achieve final form. Instead, they were in a continuous state of transition consonant with and paced by unfolding crisis events, reappraisals of crisis needs, and altered crisis objectives. Contingency planning never seemed quite able to catch up with the changing political assessments of the military situation or new policy requirements for particular military operational capabilities. Important substantive revisions kept appearing even after the prospect of implementing the plans had clearly faded.

694. Furthermore, once the planned military posture began to take overt form, planning and operations became intimately intertwined, and in some respects almost indistinguishable. Operational activity connected with repositioning of forces and materiel in preparation for implementing the plans frequently revealed internal deficiencies within the plans or unexpected constraints upon the actions being planned for thus necessitating amendments to planning provisions. Conversely, the many modifications of planning provisions that introduced new requirements or altered terms of reference resulted in changed operational preparations. The reciprocal interplay tended to be weighted on the side of the latter.

695. Since the plans were never ordered executed, they always remained "contingency" plans, forever in the realm of hypothesis. Although their substance was governed by the ultimate criteria of operational feasibility in the event of implementation, the determining variables usually were not purely military operational considerations, as such, but devolved from the

TOP SECRET

- 254 -

~~TOP SECRET~~

~~TOP SECRET~~

TOP SECRET

conditions of a larger national strategy in which the contingency plans had a supporting role. A constant revision cycle to accommodate changes in this strategic environment accordingly characterized contingency planning throughout the crisis.

696. The advent of the crisis hence did not serve to narrow the scope of contingency planning. On the contrary, it had the effect of progressively expanding the range of planning provisions, while at the same time intensifying their specificity. The magnitude of the effort, coupled with its urgency, made contingency planning one of the major preoccupations of the entire crisis, exercising the entire command and control system, from the White House to the forces in the field.

697. The same themes proved to dominate contingency planning as had been the case before the crisis. Of primary concern among these were: command relations, selective options, reaction times, and force levels. Significantly, all but the last were expressly motivated by command and control desiderata.

#### B. SETTling UPON AND APPROVING BASIC PLANS

698. One of the first considerations following the discovery of the missile sites, even before a national decision had been reached on what the U.S. response would be, was the state of the contingency plans. The need for military measures to eliminate the threat could be expected momentarily. In the present circumstances, the two operational courses of action to which precrisis planning had been oriented - air strikes or invasion (or both), had turned out to be applicable in principle if not in specific detail. The whole complex of plans, however, was still in a somewhat amorphous evolutionary stage; the

TOP SECRET

- 265 -

~~TOP SECRET~~



~~TOP SECRET~~

TOP SECRET

air-strike plans were far from complete and the invasion plans were in several versions. It was imperative that implementable plans be at hand as soon as possible. To have them, the prerequisite starting point was to settle upon a single basic plan for each of the two courses of action and get it approved. Only then could all of the explicit technical details organic to a full operation plan be systematically developed.

699. The air-strike plan, CINCLANT OPLAN 312-62, as the course of action most apt to be executed first and on the shortest notice, immediately received priority attention. It will be recalled that the core of the air-strike plan was based on the USAF "ROCK PILE" plan prepared by COMFAC, which CINCLANT had accepted as a basis for his OPLAN 312 two weeks before the crisis broke. Many aspects of the 312 plan had, of course, been undergoing development since its inception the previous February. At this point, however, it consisted of little more than a general outline containing tentative statements of the mission, concept of operations, and command relations, plus identifying some of the tasks, objectives, and support requirements involved. Most of the Annexes that flesh out a plan were still missing. Consequently, few of the specific provisions governing what operations would actually be conducted, by whom, and how, were as yet defined. Other than informal approval for planning purposes, OPLAN 312-62 had not even been officially approved by JCS as the contingency operation plan for the air-strike course of action.

700. While the Executive Committee of the NSC was deliberating on national decision alternatives for the initial U.S. reaction, CINCLANT rushed to completion the basic plan of OPLAN 312.

TOP SECRET

- 256 -

~~TOP SECRET~~

TOP SECRET

~~TOP SECRET~~

It contained a statement of the mission and concept of operations, and was accompanied by a new Annex A delineating tasks and specifying forces to carry them out. On 18 October the basic plan and the new Annex A, which was promulgated in the form of Change 1 to OPLAN 312-62,<sup>1</sup> were forwarded to the JCS for approval.<sup>1</sup> Late the following day (19 October) [the basic air-strike plan, now officially designated CINCLANT Contingency OPLAN 312-62 (Cuba), along with Change 1 containing Annex A, was formally approved by the JCS as an operation plan for execution when directed.<sup>2</sup>] This by no means proved to be the end of 312 planning; it continued throughout the crisis and, as described in later sections of this chapter, eventually reached elaborate lengths.

701. Concomitant with completion of the basic 312 plan was the updating of substantive operational provisions to reflect the most recent order-of-battle intelligence, especially the new targeting data on the missile sites. Ultimately, current targeting at the time of implementation was the crucial factor that would determine the scope and character of whatever operations were carried out. The time had now arrived when the probability of implementation was imminent. Therefore, on 18 October, even before the basic 312 plan had been approved, the JCS granted CINCLANT authority to release the special intelligence data acquired from aerial photoreconnaissance (hitherto extremely closely held information) for use at the operating level by tactical planners and aircrews, in order that the required targeting might be initiated.<sup>3</sup> Concurrently

<sup>1</sup>Msg, JCS 6765 to CINCLANT (Info CINCPACFLT et al.), 182356Z, Oct 62, TOP SECRET.

<sup>2</sup>Encl "A", J-3 MAL-1 (MCL-1), 21 October 1962 (Revised 1300), TOP SECRET.

<sup>3</sup>Ltr, CINCLANT to JCS, GCO200/502, [CINCLANT Contingency OPLAN 312-62 (Cuba) (S), 18 Oct 62,] TOP SECRET.

TOP SECRET

~~TOP SECRET~~

TOP SECRET

~~TOP SECRET~~

the plotting of air-strike sortie configurations, scheduling, and assignment of preparatory and support responsibilities got under way.<sup>1</sup>

702. Thus by 19 October both the essential formal and substantive bases of the OPLAN 312-62 air-strike plan had been laid and approved. There was now a specific reference point not only for the preparation of subsidiary and ancillary plans but also, as it soon turned out, for modifications amplifying or revising the original. Subsequent internal changes notwithstanding, CINCLANT Contingency OPLAN 312-62 remained the applicable air-strike plan for the duration of the crisis.

703. There was, relatively, somewhat less urgency attached to the invasion plans. For one thing, if there were to be invasion, it would be preceded by implementation of the air-strike plan above. For another, whereas air strikes would begin within hours following an execution order, the time lag intrinsic to an invasion operation was considerably greater; the interval elapsing between execution order and actual assault would amount to a grace period of at least several days. Besides, an approved invasion plan already existed, CINCLANT Contingency OPLAN 314-61 (Cuba). This OPLAN, however, was shortly to be abandoned in favor of a quicker reaction invasion plan. But the process of settling upon and obtaining formal approval of a single basic invasion plan was not by any means as clear-cut as for the air-strike plan. Nor was it accomplished nearly as quickly.

704. The beginning of the crisis had found the U.S. with two separate contingency invasion plans: OPLAN 314-61, which was

---

<sup>1</sup>Msg, JCS 6804 to CINCLANT, 200140Z Oct 62, TOP SECRET.

TOP SECRET

- 268 -

~~TOP SECRET~~

~~TOP SECRET~~

TOP SECRET

complete and approved, and a quick-reaction version of it, [OPLAN 316-61], which was neither complete nor approved. For the first ten days of the crisis both the original 314 plan and the 316 quick-reaction plan were simultaneously current and undergoing parallel development; official references to invasion planning during this period usually employed the generic term ["314/316 invasion plan."] Gradually, however, through the course of the first week the 316 plan generally came to be understood as the intended invasion plan and ultimately emerged officially as such.

705. In view of Presidential insistence on minimizing lead time, the [18-day] reaction time of OPLAN [314-61] already practically ruled it out as an invasion plan under the circumstances. Yet the quick-reaction plan, [OPLAN 316-61], had not attained anything approaching final form. In fact, on the eve of the crisis it was still lacking in definition regarding how quick the quick reaction should be. There were several tentative versions of it extant, each oriented to different reaction times ranging from [two to seven days] and all in varying stages of development. The one based on [five-day] lead time was the most advanced. As the crisis began to materialize on 16 and 17 October, however, the feasibility of meeting even a [five-day] reaction time, considering the size of the forces involved in relation to the limitations in available lift capability, was immediately open to serious question. Shortly, the case against the [five-day] version, already appearing cogent enough, was to become conclusive in favor of another consideration.

706. The concept of operations [of the 316 invasion plan called for the airborne phase of the assault (D-day) to commence [five days after the order to execute, to be followed two days later]]

TOP SECRET

- 269 -

~~TOP SECRET~~

~~TOP SECRET~~

TOP SECRET

(i.e., seven days after the order to execute, or D+2) by the amphibious assault phase. Now, in the light of growing appreciation for Cuban defense capability, the two-day spread between the two efforts to secure a lodgement on the island seemed a possibly risky fragmenting of the total initial assault strength; Cuban defensive forces might have the tactical advantage of being able to deal individually with each assault phase in turn. The airborne increment would be particularly vulnerable for the two-day period when it alone would bear the full brunt of Cuban resistance.<sup>1</sup> Sometime late on 17 October the JCS therefore decided that plans should be available which would provide for concerted timing of both assault phases of the operation. The next day, 18 October, the JCS accordingly instructed CINCLANT to plan for the two assault operations to be carried out simultaneously. To accommodate the new requirement, the JCS were prepared to authorize extending the reaction time of OPLAN 316 under this expanded concept to seven days -- that is, for D-day to be seven days after the order to execute.<sup>2</sup>

707. [A few] hours later (early on 19 October) CINCLANT apprised his Service component commanders, and CINCSTRIKE as well, of the requirement for an expanded concept of OPLAN 316 in a seven-day version. He directed that plans be prepared accordingly, in addition to the existing five-day version, so as to provide for simultaneous airborne and amphibious assault on the seventh day after the execution order to implement the invasion plan. He stipulated that this seven-day version was to be completed by 27 October.<sup>3</sup> This expanded concept and extended reaction<sup>3</sup>

<sup>1</sup>CINCLANT Historical Account of Cuban Crisis - 1962 (U), 29 Apr 63, TOP SECRET.

<sup>2</sup>No record has been found of a formal JCS message transmitting these instructions, but they are referred to in several existing documents. Presumably they were conveyed by secure voice telephone directly between principals.

<sup>3</sup>Msg, CINCLANT to CINCAFLANT, CINCARLANT, CINCLANTFLT, and CINCSTRIKE, 190628Z, Oct 62, TOP SECRET.

TOP SECRET

- 270 -

~~TOP SECRET~~

TOP SECRET

~~TOP SECRET~~

[Time were confirmed by CINCLANT on 22 October when he promulgated changes in command relations for CINCLANT OPLANS.<sup>1</sup> These will be discussed later.

708. In addition to the technically still current (and presumably applicable) OPLAN 314-61, there were now two primary versions of 316 plans in process, because the five-day version had not been formally and explicitly set aside when the seven-day version was introduced.] The final choice of one version over the other proved not to be a deliberate decision but emerged indirectly over the next few days as an incidental by-product of deciding [between invasion plans -- OPLAN 316 versus 314.]

709. On 24 October, CINCLANT first broached the subject of settling upon a single invasion plan. [He orally proposed to the JCS that OPLAN 314 be dropped from further consideration in favor of OPLAN 316, preferably in the seven-day version.] The following day, 25 October, he formally requested the JCS to authorize that this be done. [Reasons given were that the present posture of CINCLANT forces was oriented toward execution of OPLAN 316 on the basis of seven-day reaction time. Moreover, the seven-day version of 316, in CINCLANT's judgment, compared favorably with the 314-61 plan insofar as concerted application of force being brought to bear in the initial assault phase was concerned, since it now provided for simultaneous amphibious and airborne assaults and included additional infantry battle groups to be air-landed on D-day. Furthermore, complex changes in 316, because of dislocations in ARLANT staging bases resulting from changes in the 312 air-strike plan, had been accomplished, but similar changes for 314 had]

<sup>1</sup>Msg, CINCLANT to CINCPACFLT, CINCPACFLT, CINCPACFLT, et al. (Info JCS et al.), 222522Z, Oct 62, TOP SECRET.

TOP SECRET

- 271 -

~~TOP SECRET~~

TOP SECRET

~~TOP SECRET~~

[not yet been made. Finally, CINCLANT pointed out, the re-scheduling of movements involved was very complicated and, perforce, different for the two plans.]

710. The following day, 26 October, the JCS approved CINCLANT's request to abandon further planning and preparation for OPLAN 314-61. They directed that, instead, all efforts should be concentrated on OPLAN 316-61. Significantly, however, no explicit reference was made as to which reaction-time version of OPLAN 316-61 was the one selected.<sup>2</sup> The ambiguity resulting from failure to render a specific ruling on this score at that time occasioned considerable confusion over the next two or three days. (This will be discussed later in the section of this chapter dealing expressly with the problem of reaction times.)

711. [Nevertheless, on the basis of the authorization received from JCS, CINCLANT directed on 31 October that OPLAN 314-61 be suspended, except for those portions which were applicable to OPLAN 316. Annexes D, E, F, I, K, W, and Z of 314 were henceforth to be considered Annexes of 316, while the remainder of 314 was to be relegated to "file status," with no further references to it.<sup>3</sup> Late the same day, CINCLANT issued Change No. 5 to OPLAN 316-61, redesignating it OPLAN 316-62, in recognition of the extent of modification it had undergone and its new status as the current invasion plan.<sup>4</sup> The CINCLANT message promulgating the change was repeated to various interested headquarters over the succeeding days, ultimately being repeated to the JCS on 8 November.]

<sup>1</sup>Msg, CINCLANT to CINCARLANT and CINCLANTFLT (Info JCS et al), 260330Z Oct 62, TOP SECRET.

<sup>2</sup>Msg, JCS 7006 to CINCLANT, 251524Z, Oct 62, TOP SECRET.

<sup>3</sup>Msg, CINCLANT to JCS, CINCARLANT, et al., 311904Z, Oct 62, TOP SECRET.

<sup>4</sup>Msg, CINCLANT to CINCARLANT, et al., 010018Z, Nov 62, TOP SECRET.

TOP SECRET

- 272 -

~~TOP SECRET~~

~~TOP SECRET~~

TOP SECRET

712. Thus it was not until 25 October that a single basic invasion plan was formally decided upon, and not until 31 October that CINCLANT Contingency OPLAN 316-62 (Cuba) in the seven-day reaction version was established unequivocally as the one that would govern in the event of invasion. Both the 316 invasion plan and the 312 air-strike plan, once they were approved, remained thereafter the only applicable operation plans for Cuba for the duration of the contingency. Throughout the crisis, however, these plans continuously underwent important substantive change, either in the form of revision or expansion, until well after the military phase was over.

713. Cuban contingency planning proved to be one of the major preoccupations of the JCS. Therefore, before examining in detail the nature of the changes to the plans and the JCS role in making them, it is in order first to characterize the structure and processes that obtained in the Organization of the Joint Chiefs of Staff for carrying out the planning function in connection with the Cuban contingency. A brief explanation of the relationship of such planning to the functions of other elements of JCS involved in Cuban crisis activities also is indicated.

#### C. THE J-3 CUBAN PLANNERS

714. Within the Joint Staff of OJCS the staffing of actions pertaining to Cuban contingency plans continued to be performed, as before the crisis, by a special group. This group, however, was now a different one and, as large-scale military preparations began to get under way, operated progressively in less isolation than its predecessor.<sup>1</sup> The earlier ad hoc

<sup>1</sup>NOTE: The information on which this description of the Cuban Planners is based has been derived primarily from interviews with various members of the J-3 staff, both from among the Cuban Planners and in other J-3 elements, whose experience during the Cuban crisis touched upon the planning matters discussed. In addition, the JCS files and other J-3 records have been a source of useful clues.

TOP SECRET

- 273 -

~~TOP SECRET~~



TOP SECRET

~~TOP SECRET~~

inter-Directorate Cuba Planning Group (the so-called Johnson Group) lost its central position as the overall coordinating agency for Cuban planning for JCS, and planning activities shifted into somewhat more regular channels of the established institutional structure of JCS, largely devolving upon J-3 (except for UW Plans). Nevertheless, even within J-3 the staffing function was discharged by a separate team whose exclusive province was Cuban contingency plans.

715. It was the Combat Plans Branch of the Operations Plans Division of J-3, specifically the regional section concerned with the Atlantic-Caribbean area, that formed the nucleus of the team that assumed primary staff responsibility for Cuban contingency planning in JCS. At first only two officers, one of whom had been a key participant in the earlier precrisis group, had detailed knowledge of the plans under development and carried the staffing load. Later two other officers were added to assist them, and together the team came to be known as the Cuban Planners. They served as the JCS action officers for specific Cuban contingency planning matters, and, as JCS custodians of planning information, they kept plans currently posted, provided the planning input for the J-3 MCL, and were responsible for giving briefings on contingency plans.

716. The Cuban Planners, rather than functioning as an integral part of the Combat Plans Branch under the Operations Plans Division, operated independently of formal organizational channels directly under the Director, Operations Directorate (J-3). In fact, during the early transitional period from 16 October, when the initial military reactions to the discovery of the missiles began to take form, until 21 October, when the Joint Battle Staff was constituted, the Cuban Planners

TOP SECRET

- 274 -

~~TOP SECRET~~

TOP SECRET

~~TOP SECRET~~

worked in the immediate offices of the Director (J-3). This arrangement was partly in the interest of security, but was also necessitated by the intimate involvement of the Director in Cuban planning during the crucial first days of the crisis.

717. In view of the extreme secrecy that shrouded Cuban planning before the crisis, very few individuals in JCS had been allowed to be privy to planning information. With the onset of the crisis, even tighter security restraints were applied initially, although inevitably an ever-widening circle became cognizant of the plans, in part or in one degree or another, because of "need-to-know" to perform other functions related to the plans (e.g., status of forces, troop movement tables, sea and airlift requirements, etc.). Then increasingly, as the U.S. military response to the crisis became more overt, the security sensitivity was blunted; simultaneously more of the JCS staff became involved in activities affecting or affected by the contingency plans. Nevertheless, few of the J-3 personnel who would have a role in the crisis as members of the Joint Battle Staff (JBS), the MCL Team, the Blockade Group, or in the LANT-CARIB Branch of the Current Operations Division, had anything approaching a comprehensive grasp of CINCLANT OPLANS applicable to the crisis until 19 October. At the time the Director, J-3, read in selected individuals, including most of the LANT-CARIB Branch and some of the Current Actions Center staff, on the general outline of the plans. The remainder of the CAC staff was briefed, in somewhat greater detail, by the Director the following day, 20 October.

713. When the Joint Battle Staff was activated on 21 October, most of its members still had little or no familiarity with

- 275 -

TOP SECRET

~~TOP SECRET~~

TOP SECRET

~~TOP SECRET~~

the Cuban contingency plans. None of the planning officers with precrisis experience in Cuban plans were assigned to the JBS Teams. Instead, the Cuban Planners, as indicated above, remained a distinct entity separate from the Joint Battle Staff. However, shortly after the JBS was formed, the Cuban Planners did transfer the locus of their planning activity from the Director's office to the NMCC complex, occupying the Plans Plot Room next to the CAC Room where the JBS was located. The conduct of planning and the CINCLANT Contingency OPLANS themselves were thus in physical proximity to the JBS, permitting ready access to planning data as needed.

719 Throughout the crisis the functional relationship of the Cuban Planners to the JBS was on an informal basis; it followed no established procedures. At the time the JBS was activated there was no systematic briefing of its membership at large by the Planners. The Planners did, however, fill in the Team Chiefs on the substance of the current plans on 21 October, and the Team Chiefs, in turn, subsequently passed much of the information to individual members of their respective teams as background terms of reference in connection with specific problems. Thereafter, any additional JBS information requirements regarding contingency plans were met by personal ad hoc requests to the Planners whenever the occasion arose.

720. The JBS itself did not participate substantively in planning activities, other than passing action to Planners. Normally, to keep itself apprised of any action taken by JCS that might materially affect or alter Cuban plans, the JBS had to depend largely on come-back copies of outgoing JCS messages. Similarly, if an action bearing upon plans was taken outside JCS, the JBS had resort to courtesy copies of

- 275 -

TOP SECRET

~~TOP SECRET~~

TOP SECRET

TOP SECRET

the information message coming into JCS, since an advance copy or regular hard copy was usually distributed to JBS as a matter of routine.

721. In practice, there was also an ancillary interpersonal exchange of information between interested parties that was especially important in cases of actions having serious impact on or significantly modifying existing planning provisions. In such event the Planners on their own initiative would alert not only the responsible JBS members but LANT-CARIB and other officers as well, advising them of any changes imminent, in process, pending, or completed.

722. The Cuban Planners were, of course, in a uniquely advantageous position to render this service. As JCS action officers for planning matters, the particular Planner involved was required to stand by during JCS meetings in the Gold Room whenever a planning item was on the agenda for JCS consideration, in order that he be available to support the action he had prepared. In the absence of a systematic debriefing procedure on JCS meetings, this action officer proved to be the chief source relied upon by other J-3 staff officers to learn what had transpired regarding planning at the JCS meeting. Imperfect as the method was, it was the only way of obtaining relatively advance warning of decisions made, issues raised, and new requirements laid on that heralded change in the basic frame of reference for current or future operations related to contingency plans.

723. Between the Cuban Planners and the LANT-CARIB Branch of the Current Operations Division, coordination was, of necessity, particularly intimate, but again informal and interpersonal.

TOP SECRET

- 277 -

TOP SECRET

TOP SECRET

Rather than following explicit established procedures, the interrelationship was largely functionally self-defined, by virtue of the reciprocal influence of their respective activities and the often overlapping nature of their areas of responsibility. During the crisis, distinguishing between operational matters and planning matters was sometimes an arbitrary distinction. It followed that a compelling need for exchange of information was mutual.

724. The J-3 Cuban Planners, thus, were the focus of military contingency operation planning during the Cuban crisis for the JCS, for the Department of Defense, and for the U.S. Government. Functioning in a staff capacity, their role was an instrumental one in effecting an accommodation between the contingency plans and changing policy, on the one hand, and between contingency plans and changing military capabilities, on the other.

D. CONSOLIDATING THE COMMAND STRUCTURE

725. One of the first orders of planning concern was reappraisal of command relations provided for in contingency plans in the light of the nature of the crisis. As soon as the full implications of the Cuban situation became apparent, it was recognized that the crisis at hand was not the localized off-shore contingency on which existing provisions for tactical command arrangements had been predicated, but an ambivalent one of potentially strategic dimensions. Any limited war operations would inevitably impinge directly upon general war considerations--not solely by virtue of political context, but because of the actual presence of deployed Soviet forces and arms in the objective area; inescapably, the more serious military confrontation was directly with the USSR. Moreover, not only was a significant portion of territorial COMUS now included within the contemplated combat arena, both offensively as an operational

TOP SECRET

~~TOP SECRET~~

TOP SECRET

base and defensively as a target, but the sheer magnitude of U.S. forces involved in prospective Cuban operations affected major CONUS commands, in some cases to the extent that the bulk of their available force resources would have to be committed in support of Cuban contingency plans. Finally, in view of the scope, gravity, and delicacy of the total situation, political requirements imposed at the Executive level could be expected to demand, to an exacting and intensive degree, a precisely controlled, discriminate responsiveness of tactical military forces to national decision-making authority.

726. In the present circumstances neither the classic organizational device of a provisional task-force command structure, nor a simple functional division of operational responsibilities according to traditional Service interests, would adequately ensure the desired measure of integrated control at the proper level. What seemed to be indicated was a centralization of control over all forces participating in contingency operations at some common point that would be on a low enough command echelon to be tactically effective, yet high enough to be directly responsive to seat-of-government direction.

727. Accordingly, early in the crisis CINCLANT, with at least tacit concurrence of the JCS, began to acquire for himself control over contingency planning and operations. But first, certain institutional obstacles had to be overcome. CINCLANT's de facto position as a Unified Commander was somewhat ambiguous with regard to joint contingency operations, especially during the transitional stage from planning to implementation of plans. Under the Unified Command Plan his de jure status was identified as that of Unified Commander. In point of fact, however, under normal conditions his command, LANTCOM, consisted of naval

TOP SECRET

- 270 -

~~TOP SECRET~~

TOP SECRET

~~TOP SECRET~~

forces only, with forces of the other two Services to be included "when provided." As yet, CINCLANT had no Air Force or Army forces assigned, nor had activation of a truly joint staff fully representing all three Services been authorized for LANTCOM headquarters. Thus, although referred to as a Unified Commander, CINCLANT's situation was in reality analogous to a Specified Commander. Actually the Air Force and Army forces involved in CINCLANT's contingency plans for Cuba were part of STRICOM, under COMTAC/CINAFSTRIKE and CGCONARC/CINCARSTRIKE, respectively, and CINCSTRIKE entertained some expectations of himself exercising control of these forces when committed to operations such as those contemplated for Cuba. There were, besides, internal difficulties regarding command organization within the CINCLANT OPLANS themselves. Beginning on 18 October and over the succeeding few days the command ambiguity was resolved and deficiencies in the plans rectified by increments until the desired centralization of tactical operational control in CINCLANT was assured.

728. [Again priority attention was given to the air-strike plan. OPLANS 314-61 and 316-61 already contained provisions delineating command relationships in detail, although these were to undergo radical change shortly. In the case of OPLAN 312-62, command matters had not received much emphasis beyond geographical allocation of air-strike targets between the Navy and Air Force.] Presumably the two participating Service forces would operate independently of each other, but who would be the authority to coordinate their respective efforts, or to adjudicate wherever spheres of functional responsibility overlapped (e.g., air cover, deception and evasion, search and rescue), was not clearly defined. Indeed, how the commander

TOP SECRET

- 280 -

~~TOP SECRET~~

TOP SECRET

~~TOP SECRET~~

of the Air Force strike element designated in the plan (CG, 19th Air Force) would relate to the next higher commander -- or even identifying that command echelon -- was not specified; ostensibly it would not be CJTF-122, the prospective invasion commander, for OPLAN 312-62. At this stage none of these command-relations questions were as yet satisfactorily answered and codified in 312 planning provisions.

729. On 18 October CINCLANT issued in message form Advance Change 1 to {OPLAN 312-62} containing only part of the entire Change 1 that was to be issued subsequently. Advance Change 1 promulgated a wholly new Annex A (Task Organization and Forces) for 312, the substance of which was as follows:

a. The joint commander of all forces involved in 312-62 would be CINCLANT himself.

b. Forces involved in air strikes on the western half of Cuba would be under the operational control of CINCAFLANT (COMTAC) and would be organized into an Air Force Task Force commanded by the Commander, 19th Air Force. Included in this Air Force Task Force would be, besides Air Force units, one Marine Air Group at Key West and one Navy Carrier Air Group located at Jacksonville/Sanford.

c. Forces involved in air strikes on the eastern half of Cuba would be under the operational control of CINCLANTFLT and would be organized into a Naval Task Force, the commander of which would be designated by CINCLANTFLT. Included in the Naval Task Force would be, besides Navy air units, one Marine Air Group

d. Forces involved in the defense of Guantanamo in connection with {OPLAN 312-62} would be under the operational control of COMANTDEFJCOM and would include the Guantanamo

TOP SECRET

- 281 -

~~TOP SECRET~~



~~TOP SECRET~~

TOP SECRET

Naval Base forces presently assigned (less Marine Air elements), plus reinforcement forces to consist of [one] BLT from CARIB PHIBRON, [one] Marine Infantry Battalion to be airlifted from CONUS, and any other Navy or Marine augmentation forces that might be provided.

e. Forces involved in unconventional warfare operations in connection with OPLAN 312-62 would be under the operational control of the Commander, Joint Unconventional Warfare Task Force Atlantic (COMJUNWTF), who would be directly responsible to CINCLANT.<sup>1</sup>

730. The following day, 19 October, the JCS, although listed only as an information addressee in CINCLANT's message above, granted tentative approval of Advance Change 1 for planning purposes.<sup>2</sup> In the interim, on 18 October CINCLANT had forwarded to JCS the complete Change 1, accompanied by all of the current OPLAN 312-62 to which it applied.<sup>3</sup> Late the next day, 19 October, the JCS formally approved CINCLANT OPLAN 312-62, including Change 1 thereto.<sup>4</sup>

731. Up to this time the operational control of Air Force units committed to CINCLANT contingency plans, as well as of Army forces so earmarked, still resided under the jurisdiction of CINCSTRIKE. Thus on the morning of 20 October, immediately following JCS formal approval of Change 1, the Chairman, JCS, in an "exclusive" message to CINCSTRIKE and for similarly exclusive information of CINCLANT and each of the Service chiefs, alerted relevant key individuals that in the event of U.S.

<sup>1</sup>Msg, CINCLANT to CINCPACFLT and COMANTDEFCON (Info JCS et al), 181612Z Oct 62, TOP SECRET.

<sup>2</sup>Msg, JCS to CINCLANT, JCS 6785, 192024Z Oct 62, TOP SECRET.

<sup>3</sup>Ltr, CINCLANT to JCS, 000200/502 "CINCLANT Contingency OPLAN 312-62 (Cuba)(S)," 18 Oct 62, TOP SECRET.

<sup>4</sup>Msg, JCS to CINCLANT, JCS 6804, 200140Z Oct 62, TOP SECRET.

TOP SECRET

- 282 -

~~TOP SECRET~~

~~TOP SECRET~~

TOP SECRET

military action against Cuba the JCS were prepared to change operational control of the Air Force and Army units included under CINCLANT OPLANS from CINCSTRIKE to CINCLANT.<sup>1</sup>

732. Within a few hours CINCLANT effectively took the first step toward activating LANTCOM as a Unified Command headquarters. He designated COMTAC and CGUSCONARC as CINCAFLANT and CINCARLANT, respectively, to serve as interim Air Force and Army component commanders under CINCLANT for contingency planning, while CINCLANTFLT would continue as the naval component commander for both planning and operations.<sup>2</sup> At the same time CINCLANT also took important steps to overcome deficiencies in the provisions governing command relations contained within contingency plans. In the process the character of the planned command structure was altered radically.

733. That part of the former planned organization of forces participating in contingency operations that cast them into component task forces according to Service was generally retained: Commander 19th Air Force would be commander of the Air Force Task Force, COMPHIBLANT would be commander of the Navy Task Force (COMNAVTASKFOR); and CG XVIII Airborne Corps would be commander of the Army Task Force. All concerned were now advised, however, that during actual contingency operations CINCLANT would himself exercise "operational command" of each Service Task Force through his respective LANTCOM component commander.<sup>3</sup>

734. Then CINCLANT spelled out what the operational command channels were to be for each of the plans once they were ordered

<sup>1</sup>Msg, JCS 6806, CJCS to CINCSTRIKE (Info CINCLANT, CSA, CSAN, CNO, CMC) EXCLUSIVE for Adams, Denrison, Wheeler, LeMay, Anderson, Shoup, from Taylor, 201209Z Oct 62, TOP SECRET.

<sup>2</sup>Msg, CINCLANT to JCS et al., 201716Z Oct 62, SECRET.

<sup>3</sup>Ibid.

TOP SECRET

~~TOP SECRET~~

TOP SECRET

~~TOP SECRET~~

executed. In the conduct of operations incidental to implementation of the 312 air-strike plan, CINCLANT designated CINCAFLANT to exercise operational control of all air units (Air Force, Navy, and Marine) that were assigned targets not related to defense of Guantanamo; control of air operations connected with defense of Guantanamo would be exercised by CINCLANTFLT through COMNAVTFOR. In the conduct of operations incidental to implementation of the 314-316 invasion plans, CINCLANT would exercise operational control of the three Service Task Forces directly through the appropriate LANTCOM component commander. Commander Joint Task Force 122 (CJTF-122) and the JTF headquarters were accordingly to be dissolved and the functions of joint commander assumed by CINCLANT himself. The earlier provisions for Commander Joint Task Force, Cuba (CJTF-Cuba) subsequent to the initial assault, however, were to remain, except for one significant change. It was CINCARLANT (CG CONARC) who was now designated to become CJTF-Cuba, when directed by CINCLANT, in lieu of the commander of the Army Task Force (CG XVIII Airborne Corps) previously designated in plans.<sup>1</sup> This last item reflected Department of Army proposals nominating CG CONARC/CINCARLANT to be CJTF-Cuba going back to 16 October.<sup>2</sup> The new command role of CG CONARC, however, proved to be short-lived and, as discussed later, soon was rescinded.

735. Another aspect of command arrangements that also had to be considered was the relationship to each other of command structures under the respective plans. Since the invasion plan, if implemented, would be preceded by the air-strike plan

<sup>1</sup>Msg, CINCLANT to JCS et al., 201716Z Oct 62, SECRET.

<sup>2</sup>DA ODCS OPS Army War Room Journal (Cuban Crisis), TOP SECRET; CINCLANT Historical Account of Cuban Crisis - 1962 (U), 29 Apr 63, TOP SECRET

TOP SECRET

- 23 -

~~TOP SECRET~~

~~TOP SECRET~~

TOP SECRET

(although it was by no means inevitable that invasion follow the air strikes), there would be a period of overlap while assault operations were in the process of being mounted.

CINCLANT ruled that, should invasion have been decided upon, during the transition from the air-strike plan to the invasion plan the command and control arrangements provided for in the 314-316 plan would become effective 24 hours prior to D-day of the invasion assault. When the seven-day reaction time was finally set for the 316 plan (see section below dealing with reaction times), this meant that CINCLANT would declare the 316 command arrangements in effect six days after the beginning of the execution of OPLAN 312 air strikes.]

736. Thus CINCLANT set the stage for considerable tightening and consolidation of the planned command arrangements in the event Cuban contingency operations were executed. Occupying the apex of the projected tactical command structure would be CINCLANT, with immediate control over the conduct of all stages of those operations.

737. By this time (20 October), however, contingency preparations were beginning to pass beyond mere planning and were entering into a proto-operational phase. Although contingency planning went on at an increasingly intensive pace, the commitment need for attaining maximum readiness posture to execute the plans if ordered resulted in the forces associated with contingency plans being operationally affected. Soon the alerting and movement of units, repositioning of equipment and supplies, and forward deployment of strike forces to advance staging areas or to actual bases of tactical employment would amount to partial

---

<sup>1</sup>CINCLANT Historical Account of Cuban Crisis - 1962 (U),  
29 Apr 63, TOP SECRET.

TOP SECRET

- 285 -

~~TOP SECRET~~

~~TOP SECRET~~

TOP SECRET

Implementation of contingency plans. In fact, the scope and complexity of operational activity reached such a point by 21 October that activation of a Joint Battle Staff (JBS) in JCS was warranted, and, although not officially established until 22 October, it began functioning that same day.

738. At this juncture and in the light of the course that developments were already taking, the JCS decided to accede to the dictates of the situation by vesting in CINCLANT actual operational control over forces included under Cuban contingency plans, in addition to control over contingency planning for future employment of those forces. Late on 21 October the JCS directed CINCSTRIKE to transfer to the temporary operational control of CINCLANT all Air Force and Army forces under CINCSTRIKE's control that were assigned to CINCLANT/OPLANS 312-62, 314-61, and 316-61<sup>1</sup> Whereupon CINCLANT, in turn, directed his component commanders, CINCAFLANT and CINCARLANT, to assume temporary operational control, respectively, of CINCSTRIKE's Air Force and Army forces earmarked for Cuban contingency plans<sup>2</sup>

739. CINCLANT thereby gained the full operational status and command capacity of a Unified Commander for both planning and control of forces, whereas CINCSTRIKE had been excluded from any direct role in the command and control system bearing upon present or planned U.S. actions addressed to Cuba. This was to remain CINCLANT's basic external command context for planned contingency operations for the duration of the crisis.

<sup>1</sup>Msg, JCS 6344 to CINCSTRIKE (Info CINCLANT, CINCAFLANT (C2, FAC), CINCARLANT (C2, CONARC), et al.), 220722Z Oct 62, TOP SECRET.

<sup>2</sup>Msg, CINCLANT to CINCAFLANT and CINCARLANT (Info JCS, CINCSTRIKE et al.), 221648Z Oct 62, TOP SECRET.

TOP SECRET

- 286 -

~~TOP SECRET~~

~~TOP SECRET~~

TOP SECRET

740. [A somewhat analogous episode touching upon CINCLANT-CINCSTRIKE command roles, one triggered by the Cuban crisis but only marginally related, occurred a few days later. On 28 October the JCS, reacting to signs of possible resurgence of the dormant Congo situation, proposed to CINCLANT that, as a precautionary move, responsibility for Africa south of the Sahara, an area encompassed within the geographical boundaries allocated to LANTCOM, be temporarily transferred to CINCSTRIKE to relieve CINCLANT while under the pressure of Cuban requirements.<sup>1</sup> CINCLANT's reply the next day was "strongly disagree with proposal..." Admitting that he was using the members of JTF-4 (CINCLANT's Africa planners) to augment his Cuban staff, he requested additional personnel to replace them in order that he might then reconstitute the original JTF-4 with the same experienced officers.<sup>2</sup> No decision was immediately forthcoming and eventually the issue itself was overtaken by events, but CINCLANT did retain intact his collateral African command responsibilities despite the demands of the Cuban crisis.]

741. No sooner were these institutional changes bearing upon CINCLANT's external command relationships completed than CINCLANT put into effect the internal changes in planned tactical command for Invasion operations in accordance with his announcement of 20 October. [It will be recalled that CINCLANT had already effectively made provisions for himself to exercise operational control of OPLAN 312 forces, primarily through his Air Force component commander, CINCAFANT. Over the next two days, consistent with the pattern for the air-strike plan, a similar centralization of tactical control over invasion operations was applied to OPLANS 314-316.]

<sup>1</sup>Msg, JCS 7067 to CINCLANT, 281625Z Oct 62, TOP SECRET.

<sup>2</sup>Msg, CINCLANT to JCS, 291918Z Oct 62, TOP SECRET.

TOP SECRET

- 287 -

~~TOP SECRET~~

TOP SECRET

~~TOP SECRET~~

742. On the evening of 22 October, CINCLANT, in his new capacity as a full-fledged Unified Commander, formally promulgated the new command structure for invasion operations that had been outlined two days earlier. He disestablished CJTF-122 and himself assumed the functions of joint commander, stipulating that except for dissolution of the subordinate JTF command the substantive provisions of current CJTF-122 contingency plans were otherwise to remain in effect. Paralleling his role for the implementation of OPLAN 312, he specified that he would exercise operational control over all forces involved in OPLANS 314-316 through his Service component commanders (CINCAFLANT, CINCLANTFLT, CINCARLANT), plus COMJUFWA and the existing LANTCOM subordinate commander COMANTDEFCON. This categorical provision, however, was not without an element of ambiguity, as will be seen shortly. Although the intermediary joint command echelon represented by CJTF-122 had been eliminated, the standing provisions for a subordinate joint command subsequent to the initial assault were retained, with CJTF-Cuba to be established and forces assigned when directed by CINCLANT. But here the previous amendment regarding CJTF-Cuba contained in CINCLANT's message of 20 October naming CINCARLANT/CG COMARC to be CJTF-Cuba (vice CG XVIII Airborne Corps) was again modified, changing back to the original arrangements. Instead of CINCARLANT, CG XVIII Airborne Corps was redesignated to be CJTF-Cuba, to exercise operational control over all land forces (Army and Marine) during the post-assault phase of ground operations until the invasion mission was accomplished. CG XVIII Airborne Corps as CJTF-Cuba would report directly to CINCLANT -- not through CINCARLANT.<sup>1</sup>

743. The last point regarding who was to be CJTF-Cuba and under whom he would operate in that capacity apparently raised

<sup>1</sup>Msg, CINCLANT to CINCARLANT, CINCAFLANT, CINCLANTFLT, COMANTDEFCON, COMJUFWA, and CINOSTRIKE (info JCS et al.), 222322Z Oct 62, TOP SECRET.

TOP SECRET

- 238 -

~~TOP SECRET~~

~~TOP SECRET~~

TOP SECRET

some query, for in less than two hours CINCLANT, in another message addressed directly to JCS and pertaining to this subject exclusively, reiterated these provisions regarding CJTF-Cuba: CG XVIII Airborne Corps would be CJTF-Cuba in lieu of CINCARLANT and would operate directly under CINCLANT.<sup>1</sup> From all indications CINCLANT was not overruled and his planned command arrangements for CJTF-Cuba were retained.

744 Sometime shortly thereafter CINCLANT further amended command arrangements with significant effect on the role of CINCARLANT/CG CONARC. During implementation of 314-316 the forces involved were still to be organized into three task forces according to Service. For the assault phase of implementation, the commanders of the Navy Task Force and Air Force Task Force were placed under CINCLANTFLT and CINCAFLANT, respectively; the commander of the Army Task Force, however, was placed directly under CINCLANT, rather than under CINCARLANT. For the postassault phase, the three Service Task Forces were placed under CJTF-Cuba (CG XVIII Airborne Corps), who, as indicated earlier, would be directly under CINCLANT.

745 It will be noted that CINCARLANT/CG CONARC, although allocated a role in CINCLANT's contingency planning, had been excluded from the operational command structure for implementing of plans, both during the assault and postassault phases. Instead, CG XVIII Airborne Corps occupied the ranking Army position under CINCLANT. In this sense the status of CINCARLANT/CG CONARC was an anomaly, inasmuch as his other Service component counterparts, CINCAFLANT/COMTAC and CINCLANTFLE, did have a command role assigned for operations, both under OPLAN 312 and the assault phase of 314-316.

<sup>1</sup>Msg CINCLANT to JCS, 230040Z Oct 62, SECRET

TOP SECRET

- 299 -

~~TOP SECRET~~



TOP SECRET

~~TOP SECRET~~

746. The next day, 23 October, CINCLANT requested JCS authorization to activate JMWTF as provided for in Annex Y to OPLANS 314-316.<sup>1</sup> A day later, as soon as the request was approved by JCS,<sup>2</sup> JMWTF was established under CINCLANT, with an Army major general appointed to be its commander.<sup>3</sup>

747. Thus by 24 October CINCLANT had firmly centralized in himself, as a Unified Commander directly under JCS, control over contingency planning, control over the actual forces preparing to implement those plans, and control over tactical operations when plans would be executed. The diagrams presented in Figures 4, 5, 6, and 7 show how the basic command structure was now organized. It so remained, except for minor modifications, thereafter. Functionally, however, there was considerable deviation from the formal scheme of command relationships in the hectic proto-operational activities attending Service preparations to carry out Service tasks organic to the CINCLANT mission. Moreover, this centralization of control itself created serious staffing problems for CINCLANT.

#### E. LANTCOM HEADQUARTERS STAFF ORGANIZATION

748. As early as 18 October difficulties had begun to be encountered within LANTCOM headquarters in giving practical form to the means and methods for exercising this consolidation of authority. In specific terms of organization and procedures, concrete staff arrangements were lacking to support adequately the greatly expanded command responsibilities. Simultaneously with the reorganizing of command relations, therefore, equally important changes in staff composition and structure were occurring.

---

<sup>1</sup>Msg, CINCLANT to JCS, 232038Z Oct 62, TOP SECRET.

<sup>2</sup>Msg, JCS 6943, to CINCLANT, 241753Z Oct 62, TOP SECRET.

<sup>3</sup>Msg, CINCLANT to JCS et al., 242246Z Oct 62, TOP SECRET.

TOP SECRET

- 200 -

~~TOP SECRET~~

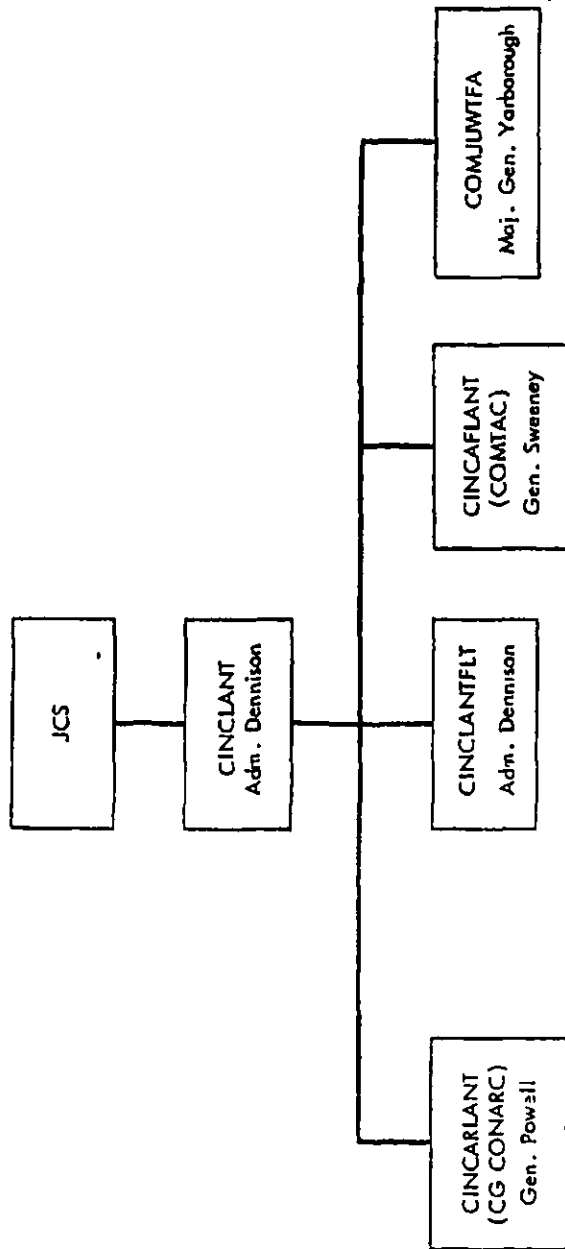

FIGURE 4 Command Relations during Planning for CINCLANT OPLANS 312/314/316

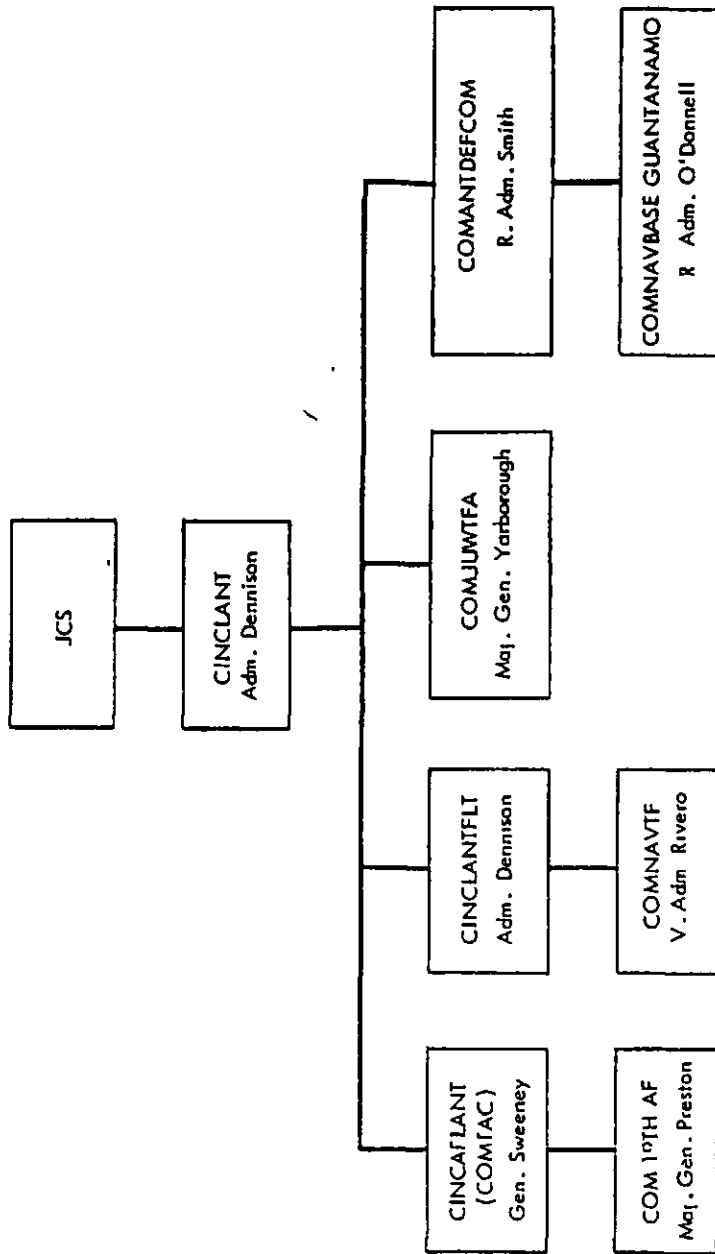

FIGURE 5. Command Relations during Implementation of CINCLANT OPLAN 312-62

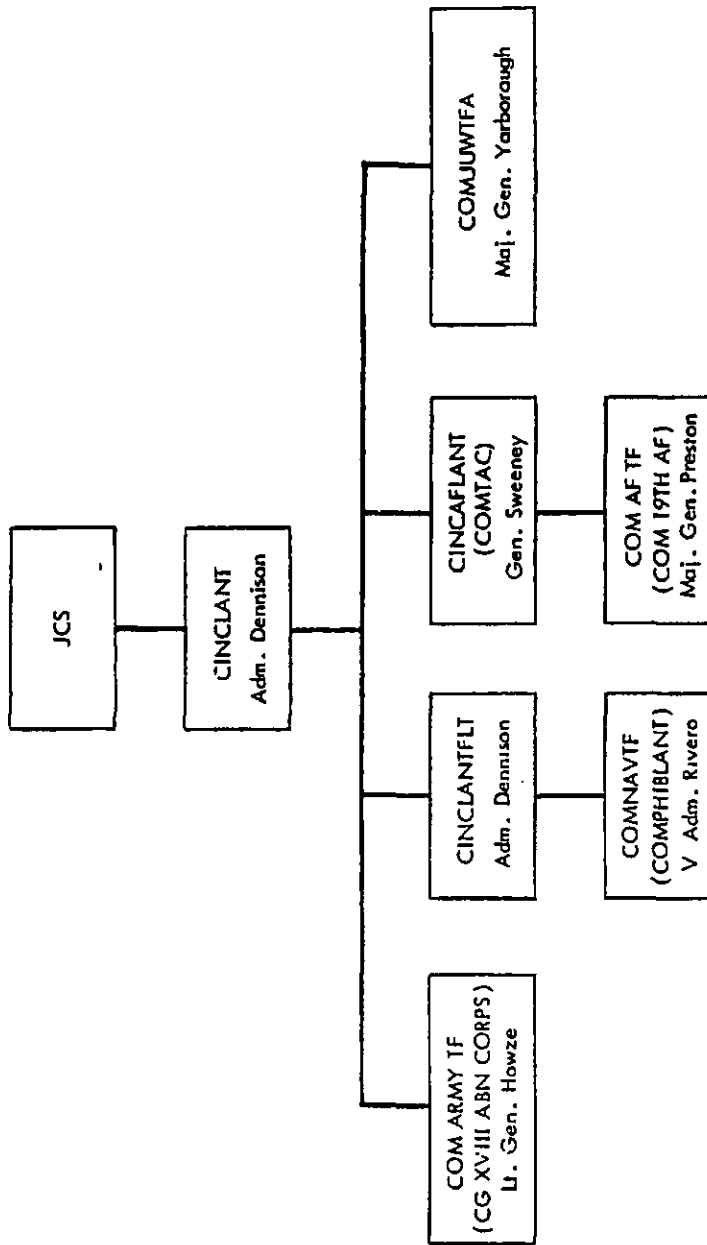

FIGURE 6 Command Relations during Implementation of the Assault Phase of OPLANS 314/316

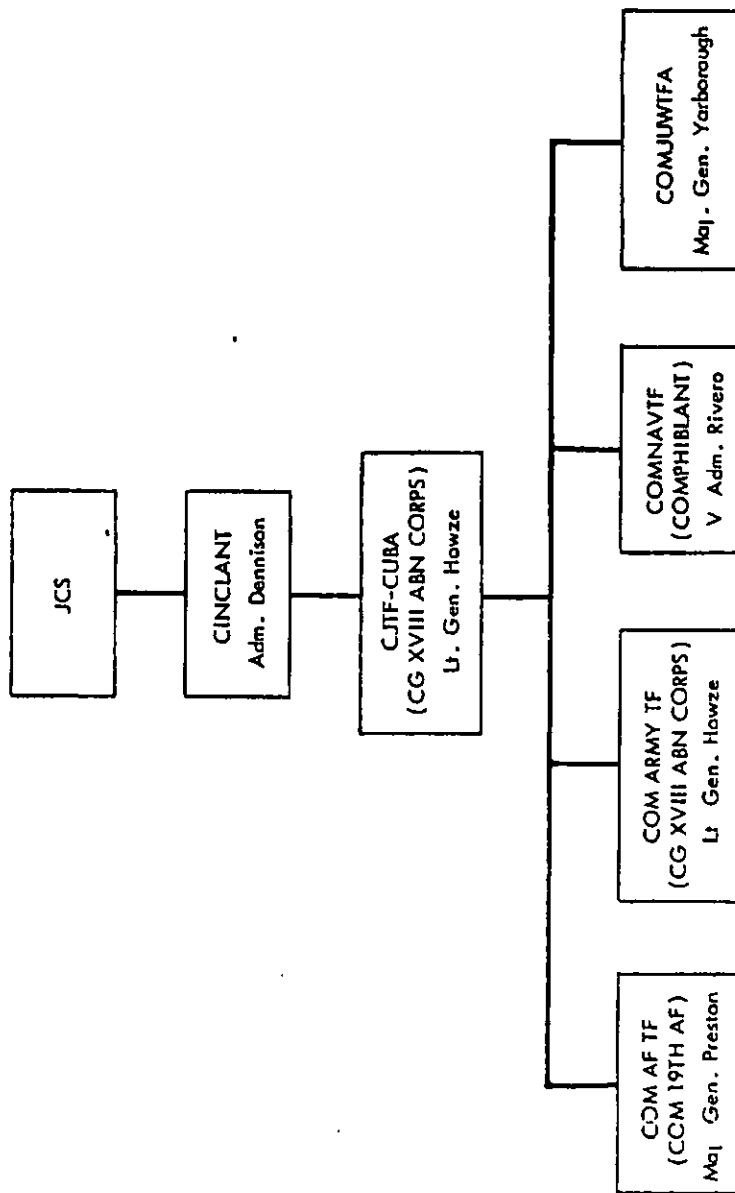

FIGURE 7 Command Relations during Implementation of the Postassault Phase of OPLAN 314/316

TOP SECRET

~~TOP SECRET~~

749. Normally only a small, token representation of Army and Air Force officers are on duty with the LANTCOM staff. It consists predominantly of Navy officers, and the same staff serves both LANTCOM and LANTFLT headquarters more or less interchangeably; organizationally and functionally the two staff capacities are indistinguishable. By 18 October the press of burgeoning Cuban activity made it apparent that the LANTCOM staff would have to be augmented. At the same time CINCLANT desired to keep separate these specifically Cuban contingency matters from his general war mission, expressly by maintaining a clear staff distinction between them. An immediate ready source of such augmentation for contingency staffing, and one that would not be at the expense of general war staffing, was conveniently at hand in the form of CINCLANT's Joint Task Force-4 (JTF-4), [a special planning headquarters for operations in Africa south of the Sahara, a region also included within the geographical boundaries of the LANTCOM area.] On 19 October, therefore, CINCLANT relieved the Army lieutenant general who was the incumbent CJTF-4 and requested CGUSCONARC to assign<sup>1</sup> him as LANTCOM Deputy Chief of Staff for Cuban planning and operations. He was so assigned the next day, 20 October.<sup>1</sup>

750. Meanwhile CINCLANT decided to go further in codifying along more institutional lines the desired distinction between contingency staffing and general war staffing. The following day, 21 October, he created a wholly separate staff exclusively concerned with Cuban matters, and named the former CJTF-4 to

---

<sup>1</sup>This description of LANTCOM headquarters is based on information contained in "CINCLANT Historical Account of Cuban Crisis-1962 (U)," 29 Apr 63, TOP SECRET, as amplified through interviews with J-3 staff officers familiar with CINCLANT organization and operations during the crisis.

TOP SECRET

- 295 -

~~TOP SECRET~~

TOP SECRET

~~TOP SECRET~~

head it as CINCLANT Chief of Staff for Cuban contingency operations. To man the new Contingency Staff, personnel were drawn largely from the JTF-4 staff, others obtained by absorbing the nucleus staff of the dissolved JTF-122, and some borrowed from the regular CINCLANT/CINCLANTFLT staff. Later, additional personnel were made available by CINCSTRIKE, CGUSCONARC, COMTAC, and by the Service Departments. At its peak this CINCLANT Cuban Contingency Staff numbered 113 officers and 69 enlisted men.

751. Since the regular CINCLANT/CINCLANTFLT staff was retained, establishment of the ad hoc Contingency Staff resulted in two independent CINCLANT staffs at the same time on the same echelon. The Cuban staff was responsible for everything related to [OPLANS 312-314-316]; the regular staff was charged with all other CINCLANT responsibilities not directly connected with Cuban crisis operations. Of the latter, the on-going general war mission of the command was now especially acute in view of the imminent danger that the contingency might escalate. Accordingly, two war rooms were maintained in CINCLANT headquarters, one for each staff.

752. A Contingency Battle Staff was activated for the War Room of the Contingency Staff, becoming operational at 0800 hours, 22 October. Charged with staffing all LANTCOM Unified Command actions relating to [OPLANS 312-314-316], its role, as originally conceived, was twofold: to be a primary action agency, and to perform the more conventional battle staff support services of monitoring and information processing. It was organized on a three-section basis, with 20 officers per section, in order to operate around the clock. A formal

TOP SECRET

- 275 -

~~TOP SECRET~~

~~TOP SECRET~~

TOP SECRET

battle staff as such was not activated for the War Room of the regular CINCLANT/CINCLANTFLT staff, but augmented watches were kept on duty there in order also to provide 24-hour coverage. Very quickly, however, the concept of two separate CINCLANT staffs, each with its respective War Room and Battle Staff or watch, was abandoned de facto. Logical enough in the abstract, the arrangement proved not to work out well in practice; operationally, the theoretical distinction between Cuban contingency matters and general war matters was not as clear-cut as had been assumed. Instead, the staff functions relating to the two areas of activity impinged upon each other substantively and were inextricably intertwined procedurally. After an initial period marked by considerable confusion, an informal modus operandi soon emerged. The regular CINCLANT/CINCLANTFLT staff assumed action responsibility for contingency matters, while the Contingency Staff, to all effects and purposes, gradually merged with the regular staff. As a result, the Contingency Battle Staff lost its "action" role, reverting to the monitoring/information-support role of a conventional battle staff.

753. Paralleling the security policy in the Joint Staff of JCS, information pertaining to the Cuban crisis was extremely closely held at LAITCOM headquarters. Sensitive intelligence and reconnaissance data, or information referring to decisions regarding U.S. courses of action, were disclosed to very few individuals on either of the two CINCLANT staffs, and only on an austere need-to-know basis. Crucial items of such nature were frequently conveyed exclusively on direct line of command between principals, e.g., Chairman, JCS (or Director Joint Staff) and CINCLANT personally, without staff members being

TOP SECRET

- 297 -

~~TOP SECRET~~



TOP SECRET

~~TOP SECRET~~

privity to what transpired. This situation of restricted information flow was especially acute in the first week of the crisis. Presumably, from a working staff point of view the effect was to compound further the difficulty of providing staffing support for CINCLANT actions.

754. During its existence the Contingency Battle Staff had relatively little interaction with the JCS Cuban Joint Battle Staff. When Joint Battle Staff members had occasion to contact LANTCOM headquarters, they usually dealt with the regular CINCLANT/CINCLANTFLT staff. Similarly, members of the JCS Joint Staff, and particularly J-3 action officers, communicated directly with their counterparts on the regular CINCLANT staff. As in the case of the JCS Joint Battle Staff, the CINCLANT Contingency Battle Staff had no role in the development of contingency plans. The planning function was performed by a special group apart from the CINCLANT Contingency Staff and the regular CINCLANT/CINCLANTFLT Staff.

755. Through the month of November, as the intensity of crisis events subsided -- and in view of its already greatly circumscribed mission -- CINCLANT's Contingency Battle Staff was progressively reduced in size until finally disestablished on 3 December. Shortly thereafter the entire CINCLANT Cuban Contingency Staff itself, which for some time had existed only pro forma, was officially dissolved and the LANTCOM headquarters organization returned to its normal precrisis configuration.

F. REFRACTING THE AIR-STRIKE PLAN INTO DISCRETE OPTIONS

756. While the centralized command structure was in the process of crystallizing, there began a series of specialized refinements of the air-strike plan, each constituting in its

TOP SECRET

- 276 -

~~TOP SECRET~~

~~TOP SECRET~~

TOP SECRET

own right a specific subplan embraced by the overall 312 plan. Together they represented the range of predetermined alternatives, in terms of incremental options, that could be selectively implemented for a controlled, discriminate application of force as desired. Besides being systematically arranged in ascending order of magnitude, their individual parameters were further codified according to types of targets and reaction-time criteria. Ultimately there were six of these special subplans of CINCLANT OPLAN 312-62. All of them came into being as a result of Presidential command and control requirements.

757 The first of these special subplans of OPLAN 312 to be developed was a selective retaliatory air-strike plan. Its purpose was to provide for a limited reaction in order to achieve a limited objective, namely, in the event a U.S. reconnaissance aircraft was shot down, to discourage any repetition of such acts. With stepped-up aerial reconnaissance (both high altitude and low-altitude) now being openly conducted over Cuba, a delicate problem had arisen. For the U.S., reconnaissance was crucial, it was the key to future national decisions in the crisis, and the President was therefore determined that it be allowed to continue without obstruction. Serious concern was felt, however, lest mounting Cuban objections to these overflights hitherto confined to outraged protests, go beyond threats to impulsive acts against U.S. aircraft involved. [Presence of the sophisticated SA-2 weapon system provided the Cubans with the wherewithal and here is where sensitive policy considerations entered into what was otherwise a tactical issue, for the SAM sites were manned, at least in part, by Soviet personnel. Nevertheless, it was apparently decided that since the purpose was ]

TOP SECRET

- 20 -

~~TOP SECRET~~

~~TOP SECRET~~

TOP SECRET

[ demonstration of intent as much as punitive reprisal, retaliatory action of the appropriate degree of emphasis under the circumstances should be addressed to the SAM sites. ]

758. [ Some time on the 22nd or shortly thereafter a general requirement was accordingly placed on CINCLANT to be prepared to take appropriate retaliatory measures against SAM sites in the event that U.S. reconnaissance aircraft were destroyed. How or when this directive was conveyed is not known, but explicit terms of reference seem not to have been provided at the time. On the contrary, the detailed substance of what had actually been planned was provided to JCS and the White House considerably after the fact, almost as an afterthought. ]

759. [ The earliest record of the retaliatory air-strike plan was 23 October. On that date CINCLANT promulgated in message form a special operation plan, nicknamed "FIRE HOSE", for the selective air destruction of one or more SAM sites in response to Cuban forces shooting down U.S. reconnaissance aircraft. The plan provided for a separate task force over and above those forces already committed to the regular OPIAN 312 air strike; it specified that 16 additional F-100 aircraft would be maintained on alert readiness status so as to be airborne no later than 30 minutes after the order to execute FIRE HOSE. Included were technical operational instructions regarding the armament to be employed and how the attack was to be carried out. As to targeting, three SAM sites were named, one (or more) of which would be selected at the time of execution. ]

[ Msg, CINCLANT to 1st AD and 479 TFW ADVON, 231702Z Oct 62 ]

TOP SECRET.

TOP SECRET

- 300 -

~~TOP SECRET~~

~~TOP SECRET~~

TOP SECRET

760. CINCLANT had received an information copy of the original message promulgating FIRE HOSE, which was then repeated by CINCLANT to CINCSAC, and others, at 2202 (local time) on 24 October. Not until the evening of 27 October did CINCLANT repeat it to JCS. A few hours later, at 0143 on 28 October, the NMCC in turn repeated it to the White House. In the interim, at approximately 2200 on 27 October, CINCLANT himself had forwarded the details of the special FIRE HOSE plan in two other messages addressed directly to JCS.<sup>1</sup>

761. [It was on 27 October that a U-2 aircraft was actually lost over Cuba and low-level reconnaissance flights encountered ground fire.<sup>2</sup> The fate of the missing plane, however, was not known immediately, and by the time the fact that it had indeed been shot down was established, too long an interval had elapsed for U.S. reaction to appear unequivocally as retaliation in response to the specific Cuban act. Besides, other circumstances militating against any such use of force had interjected themselves in the meanwhile. As a result, planned retaliatory measures were not implemented at the time.]

762. [Despite the promulgation of FIRE HOSE, the issue of what the U.S. reaction should be if a reconnaissance aircraft were destroyed by Cuban forces preoccupied the President, the Executive Committee of the NSC, the Secretary of Defense, and the JCS for the next month.]

763. [Shortly after the appearance of FIRE HOSE, a finer distinction was made in the degree of retaliatory action to]

<sup>1</sup> Msgs, CINCLANT to JCS, 25 15.2 and 28C1543, Oct 62, TOP SECRET.

<sup>2</sup> USAF Hq Historical Division Liaison Office, "Headquarters USAF Chronology of the Cuban Crisis for the Period 27 Oct - 2 Nov 62," TOP SECRET.

TOP SECRET

- 301 -

~~TOP SECRET~~

~~TOP SECRET~~

TOP SECRET

[ be taken. [ FIRE HOSE became restricted to a reprisal air strike on a single SA-2 site, with the reaction time specified as two hours, while a new option was developed by CINCPACFLT on 25 October to provide for air strikes against all SAM sites.<sup>1</sup> This latter subplan of 312, also calling for a two-hour reaction time, later came to be identified by the nickname FULL HOUSE.<sup>2</sup> ]

764. [ [ third subplan was added on 28 October. CINCPACFLT, in issuing another formal change to OPLAN 312-62, divided the air-strike plan into three different categories of action in ascending order of magnitude. Category I included FIRE HOSE and FULL HOUSE, providing for selective destruction of from one to all SAM sites, and called for a readiness posture based on two-hour reaction time. Category II was a new subplan nicknamed SHOE BLACK, which applied to a wider range of targets, but still selectively; SHOE BLACK provided for air strikes against a single target or multiple targets grouped by type (SAM sites, airfields, missile complexes, and combat air patrols), with a readiness posture based on from two-hour to six-hour reaction time depending on scale of operations directed. Category III, identified as SCARBARDS, was the execution of the full OPLAN 312, with a readiness posture based on a reaction time to commence air strikes in less than 12 hours after the execution order; later the code word designation RED BLUFF was applied to the total 312 plan. CINCPACFLT was named to be target coordinator for all forces involved in air-strike operations under each of the three categories. ] ]

<sup>1</sup>JCS 2304/63, 25 Oct 62, TOP SECRET.

<sup>2</sup>Msg, CINCPACFLT to CINCPACFLT et al. (Info JCS), 050905Z Nov 62, TOP SECRET.

<sup>3</sup>Msg, CINCPACFLT to JCS et al., 181640Z, Oct 62, TOP SECRET.

TOP SECRET

- 302 -

~~TOP SECRET~~

~~TOP SECRET~~

TOP SECRET

765. [The reaction time specified by CINCLANT for SHOE BLACK occasioned a demurer from JCS a week later. Discussion of this problem is deferred to a following section dealing generally with planned reaction times.]

766. [The existence of retaliation plans expressly oriented to such an eventuality notwithstanding, when the U-2 reconnaissance plane was shot down over Cuba on 27 October none of the plans were ordered executed. For one thing, the facts surrounding the incident were not known for some time; for another, on the heels of the incident new political considerations connected with the Soviet agreement to dismantle the missile bases, followed by the U.S. decision to suspend aerial reconnaissance and lift the quarantine during U.N. Secretary General U Thant's mission to Cuba, largely precluded any military action being initiated then. Nevertheless, when reconnaissance was resumed the same questions regarding retaliation still confronted U.S. decision makers, perhaps now as an even more complex policy issue.]

767. [On 6 November, at a meeting of the Executive Committee of the National Security Council, the President requested comments on what course of action should be taken in the event that U.S. reconnaissance aircraft were either fired upon or shot down over Cuba. The two eventualities being projected were no longer hypothetical, they were identical with what had already happened when the U-2 plane was shot down and to other U.S. aircraft were fired upon. The JCS, charged with generating the military views on the policy issues involved, immediately took the problem under formal consideration. In the process they produced a JCS "Green" on the problem that culminated the next day in a memorandum from the Chairman, JCS, to the Secretary of Defense.]

JCS 2304/96, 6 Nov 62, TOP SECRET.

TOP SECRET

303 -

~~TOP SECRET~~

~~TOP SECRET~~

TOP SECRET

768. [In] response to the President's request the JCS, in a memorandum on 7 November to the Secretary of Defense, recommended that:

a. If the incident were judged to be an isolated one, the U.S. should take limited retaliatory action against the specific offending Cuban facility (weapons, weapons site, or airfield) responsible for the attack.

b. If the incident were judged to be evidence of deliberate intent on the part of Cuban authorities to resist surveillance, the U.S. reaction should be full-scale air strikes on all airfields and air-defense weapons systems in Cuba, with consideration also given to including IL-28's and the instituting of a complete blockade of Cuba.

The JCS summed up their position on the matter with emphasis, stating "There is no question in our minds . . . that if the Cuban authorities demonstrate an intention to resist our over-flights we must react promptly against the entire air defense system." ]

769. The introduction by the JCS of the somewhat irrelevant issue of the IL-28's (considering the restricted context of the specific problem being addressed) reflected the serious military concern with this remaining Cuban offensive capability, since the strategic missile threat by now had been removed. It proved to be the motivation for developing yet another subplan under OPLAN 312. Next morning (8 November), following the memorandum to the Secretary of Defense, the Chairman, JCS, directed CINCLANT, via KY-9 secure telephone, to prepare a concept of operations for destruction of the IL-28 aircraft in Cuba by selective and discriminate air attack. CINCLANT, ]

[ Memo, CJCS to SecDef, JCSM-872-62, "Recommended U S Reaction to Hostile Attack on U S. Reconnaissance Aircraft over Cuba," 7 Nov 62, TOP SECRET. ]

TOP SECRET

- 304 -

~~TOP SECRET~~

TOP SECRET

[responding that same afternoon, submitted an outline plan, designating the operation by the code name HOT PLATE.<sup>1</sup>

770. At the same time CINCLANT had, in turn, instructed CINCAFLANT to prepare an appropriate detailed operation plan for carrying out HOT PLATE. A day later, on 9 November, CINCAFLANT completed a special plan, identified as Operation HOT PLATE, as a subplan under OPLAN 312 and utilizing the forces assigned therein. It provided for destruction by air strikes of all IL-28's on Cuban airfields and at assembly bases; AFLANT forces were to attack those in the area of San Julian and Naval air of TF-135, those at Holguin. Spelled out in detail were task responsibilities, command relations, forces, missions, objectives, rules of engagement, and execution instructions.<sup>2</sup>

771 Upon it being informally concurred in by the Joint Staff of JCS and coordinated with other interested agencies, CINCLANT formally promulgated the special plan for Operation HOT PLATE on 10 November.<sup>3</sup>

772. Finally, at the end of the month the last of the subplans covering selective options under OPLAN 312 appeared. It too reflected the strong position taken by JCS regarding possible Cuban interference with reconnaissance, which had been expressed on 7 November in response to the President's request for comments. The JCS accordingly laid on a planning requirement for CINCLANT. On 29 November CINCLANT directed CINCAFLANT to prepare a special operation plan, to be identified ]

<sup>1</sup>Msg, CINCLANT to JCS (to DJS for CJCS), 081956Z, Nov 62, TOP SECRET.

<sup>2</sup>Msg, CINCAFLANT to CINCLANT, JCS, CSAF. et al., 092157Z Nov 62, TOP SECRET.

<sup>3</sup>Msg, CINCLANT to JCS et al., 102342Z Nov 62, TOP SECRET.

TOP SECRET



~~TOP SECRET~~

TOP SECRET

as ROYAL FLUSH, for air strikes against all Cuban air defenses.

This operation was to amount to the first two waves of the first strike of OPLAN 312. The next day, 30 November, CINCPACFLT promulgated special subplan ROYAL FLUSH, as Interim Change No. 37 to CINCPACFLT OPLAN 312-62, to provide for the required selective option under CINCPACFLT OPLAN 312. The planned ROYAL FLUSH operation would consist of simultaneous air strikes against primary elements of the Cuban air defense system (radar, SA-2 sites, antiaircraft, airfields, and combat fighter aircraft in the air), and would comprise the first two waves of the first strike under the full OPLAN 312.<sup>1</sup>

773. The gamut of separate options of OPLAN 312 thus ultimately numbered six, each codified into its own respective subplan.

In generally ascending order of magnitude, these ran as follows:

- a. FIRE HOSE - single SAM site.
- b. FULL HOUSE - all SAM sites.
- c. SHOE BLACK - selected target complexes.
- d. HOT PLATE - all IL-28 aircraft and assembly bases.
- e. ROYAL FLUSH - all air defense capability.
- f. RED BUFF - total OPLAN 312 air strikes

774. A somewhat related special plan, though not actually a subplan of OPLAN 312, was also developed. This plan was an outgrowth of the failure to learn promptly what had happened when the U-2 plane was shot down on 27 October. Following the incident, CINCPACFLT, at the behest of the JCS, had instructed CINCPACFLT to prepare a plan for systematic air search operations, accompanied by armed escorting aircraft, in the event a reconnaissance plane were missing. The required plan, ]

<sup>1</sup>Msg, CINCPACFLT to CINCPACFLT et al., 302358Z Nov 62, TOP SECRET.

TOP SECRET

- 306 -

~~TOP SECRET~~

~~TOP SECRET~~

TOP SECRET

Codename GREY WOLF, was produced as CINCLANT OP ORDER No 186-62. GREY WOLF was approved by CINCLANT on 8 November.<sup>1</sup>

775. The proliferation of 312 subplans, well before the list was even complete, posed problems of coordination between the air-strike plan and functionally related air-defense plans for CONUS. There was no longer a crisply defined point to distinguish exactly when OPLAN 312 was being implemented. Yet, the implementation of CINCONAD's OPLAN 1-62 for air defense of southeast U.S. was based on a binary go-no-go option geared to implementation of the 312 air-strike plan, on the logical assumption that U.S. air attack on Cuba could be expected to provoke Cuban attacks on the U.S. then if ever at all. On 5 November CINCONAD therefore requested JCS authorization to implement his OPLAN 1-62 upon implementation of any of the lesser options of CINCLANT OPLAN 312-62, as well as the full plan. The JCS at their meeting of 6 November agreed to CINCONAD's request<sup>3</sup> and so authorized him the same day.<sup>4</sup>

776. A similar problem of coordination between the 312 plan and other plans had occurred earlier and had been handled in an unusual way. About the 18th or 19th of October it was recognized that there was a strong likelihood that execution of the air-strike plan would provoke a major Cuban attack on the U.S. naval base at Guantanamo. On the one hand, the CNO, acting as JCS representative, was responsible for defense of Guantanamo (as well as for conduct of the quarantine), but on the other, he was outside the direct command line for contingency plans, except in his capacity as one member of the corporate body JCS. Yet the operations covered

<sup>1</sup>Msg, CINCLANT to JCS (Info CINCLANT) 082116Z Nov 62, TOP SECRET.

<sup>2</sup>Msg, CINCLANT to JCS, 052340Z Nov 62, TOP SECRET.

<sup>3</sup>JCS 2304/94, 6 Nov 62, TOP SECRET.

<sup>4</sup>Msg, JCS 7256 to CINCONAD, 6 Nov 62, TOP SECRET.

TOP SECRET

- 307 -

~~TOP SECRET~~

TOP SECRET

~~TOP SECRET~~

by the two plans were functionally related insofar as one could be expected to initiate the other. Since the contingency operation would be determining -- and was the more important -- the plan for defense of Guantanamo was therefore incorporated as a subordinate part of the air-strike plan. On 20 October CINCLANT issued Change No. 2 to OPLAN 312-62, promulgating Annex "L" to the basic OPLAN, which in general terms provided for a Guantanamo defense plan tied in with the contingency air-strike plan.<sup>1</sup> It is not known on what authority CINCLANT had taken such action, but presumably the particular Guantanamo defense plan contained in Annex "L" would be applicable only incidental to, and in the event of, prior decision to implement the 312 plan. Otherwise, in the absence of the air-strike plan being executed, the existing provisions of the earlier independent plan for Guantanamo defense would obtain.

777. Other, more routine, modifications in OPLAN 312 were also made throughout the course of the crisis. Some of these were normal technical revisions in operational details of targeting, sortie schedules, and task assignments, either flowing from the subplan requirements described above or to up-date plans to reflect the most current intelligence derived from photo reconnaissance, many of the 40-odd numbered interim changes to CINCLANT OPLAN 312 were of such nature. Some of the modifications, however, were more substantial. [Interim Change No 4 of 23 October, for example, provided for an immediate restrike operational cycle, specifying force configuration and employment.<sup>2</sup> Similarly, because of continuing work on missile sites in Cuba, Interim Change No. 10 of 28 October provided, at the behest of the JCS,<sup>3</sup> for the addition of a fourth wave to the ]

<sup>1</sup>CINCLANT Historical Account of Cuban Crisis - 1962 (U), 29 Apr 63, TOP SECRET.

<sup>2</sup>Msg, CINCLANT/COMTAC to AFLANT ADVON, et al., 230837Z Oct 62, TOP SECRET.

<sup>3</sup>Msg, CINCLANT SITREP to JCS, CNO, et al, 270228Z Oct 62, TOP SECRET.

TOP SECRET

- 303 -

~~TOP SECRET~~

TOP SECRET

[first air strike on MRBM/IRBM complexes. It specified the forces, armaments, targets, schedules, and entry points of attack for this fourth wave.]<sup>1</sup>

778. Besides modifications as such, there was also the need to complete missing portions of OPLAN 312. It will be recalled that the air-strike plan had not been completed before the crisis and that approval of the basic plan by JCS had been rushed through on 19 October only because of pressing urgency. Lacking was the Annex providing for an unconventional warfare (UW) plan; apparently the need for UW operations ancillary to air-strike operations was belatedly recognized. On 30 October COMJUVTFA prepared an outline plan for conduct of UW operations in support of OPLAN 312.<sup>2</sup> Based on COMJUVTFA's outline, CINCLANT, approximately eleven hours later, promulgated Annex "Y" to CINCLANT OPLAN [312-62 (Unconventional Warfare)]. It was a special adaptation of the existing UW plan provided for in Annex "Y" to the as yet not approved OPLAN 316-61, which in turn had been derived from OPLAN

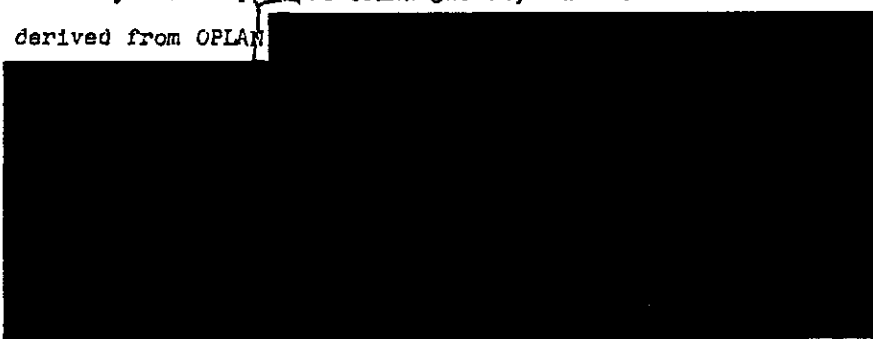

The plan in its present form, however, was not truly substantive in the sense of spelling out what the operations would actually be and how they would be carried out.

779. Only late in the evening of the following day (1 November), after assigning tasks and responsibilities for component forces

<sup>1</sup>Msg, CINCLANT to CTF 135, COMFAIRJAX et al., (info JCS), 281011Z Oct 62, TOP SECRET.

<sup>2</sup>Msg, COMJUVTFA to CINCLANT, COMARJUVTFA et al., (Info JCS et al.), 301230Z Oct 62, TOP SECRET.

<sup>3</sup>Msg, CINCLANT to JCS, COMJUVTFA, and CINCLANT, 302338Z Oct 62, TOP SECRET.

TOP SECRET

TOP SECRET

~~TOP SECRET~~

of JUWTFEA in detail,<sup>1</sup> did COMJUFWTFEA provide the JCS, CINCLANT, and others with the concept of operations on which UW planning was being based in support of OPLAN 312-62.<sup>2</sup> As a result, it was not until 5 November that the UW plan contained in Annex "Y" to CINCLANT OPLAN 312-62 was approved by the JCS. At that, approval was granted except for those parts that inter-related with OPLAN 316, which were thereby deleted.<sup>3</sup> Later, after the middle of November, a wholly new cycle of UW planning was initiated. This will be discussed in connection with OPLAN 316, to which it was more closely related.

780. Plans for psychological operations in support of OPLAN 312 also received attention. Quite early in the crisis a psychological warfare operation plan, nicknamed EUGLE CALL, had been developed and stocks of leaflets forewarning the Cuban populace that military action was imminent were printed in readiness. Tactical commanders, however, objected that such warning leaflets would preclude the advantage of surprise. Accordingly, on 1 November, EUGLE CALL was cancelled in favor of another plan and the existing stocks of leaflets already printed were ordered destroyed. The new plan, nicknamed AUTUMN LEAVES, provided guidance and directives for preparing and disseminating leaflets by airdrop at the time OPLAN 312 was implemented, in order to inform the population why the U.S. was attacking Cuban military installations. CINCLANT would be responsible for leaflet production and processing, while CINCPAC-LANT would be responsible for delivery. The leaflet text, as

<sup>1</sup>Msg, COMJUFWTFEA to CINCLANT et al., (Info JCS et al.) 010522Z Nov 62, TOP SECRET.

<sup>2</sup>Msg, COMJUFWTFEA to JCS, CINCLANT, et al., 020046Z Nov 62, TOP SECRET.

<sup>4</sup>Msg, JCS 7242 to CINCLANT, COMJUFWTFEA, 06 31, 050007Z, Nov 62, TOP SECRET.

TOP SECRET

- 310 -

~~TOP SECRET~~

TOP SECRET

~~TOP SECRET~~

E

[approved by the JCS, was provided. In addition, targets were designated, and instructions for carrying out the leaflet missions by high-speed tactical aircraft were appended.]

781



A1  
A4

<sup>1</sup>Msg, CINCLANT to CINCAFLANT (Info JCS et al.), 012010Z Nov 62, TOP SECRET.

<sup>2</sup>Msg, CINCLANT to CINCAFLANT and CINCARLANT (Info JCS), 201730Z Oct 62, TOP SECRET.

<sup>3</sup>CINCLANT Historical Account of Cuban Crisis - 1962 (U), 27 Apr 63, TOP SECRET.

TOP SECRET

~~TOP SECRET~~

G. EXPANDING AND FILLING IN INVASION PLANS

782. Concurrently with the elaboration and refinement of the 312 air-strike plan, invasion planning was also undergoing amplification and revision. If given slightly less priority, these modifications in invasion plans were perhaps of potentially more far-reaching consequence; certainly they were not as quickly adopted, and many more echelons of the total decision-making system were involved in them. Their attendant operational ramifications, moreover, had greater dislocating impact on a much larger segment of the military establishment than the alterations in the air-strike plan.

783. Even before OPLAN 316-62 was formally approved as the invasion plan, changes and additions had begun to appear. As in the case of the air-strike plan, they proved to continue throughout the crisis. One concomitant of settling upon a single basic invasion plan had been the changes in concept and in command relations previously mentioned. At the same time new substantive provisions, or amendments expanding existing provisions, were being added. Some of these were relatively peripheral, but others impinged upon central issues determining the fundamental character of whatever operations would be carried out.

784

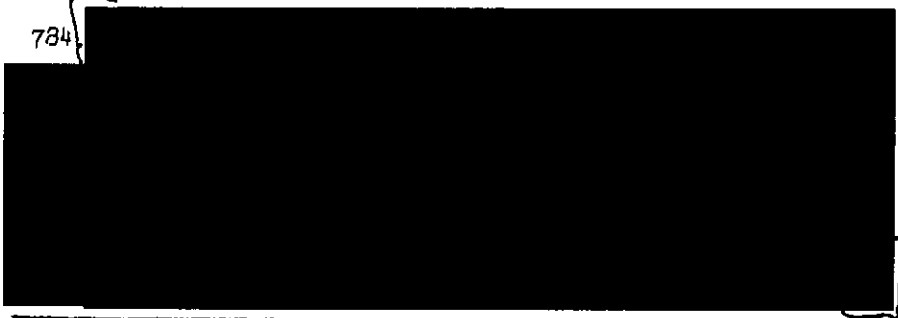

1. Msg, CG XVIII Abn Corps to COMTAC (Info CINCLANT) 211805Z Oct 62 (repeated by CINCLANT for Info JCS, 240352Z Oct. 62), TOP SECRET.

785. Also on 21 October considerable attention began to be given to civil affairs provisions in invasion planning. On that day the Chief of Staff, Army, acting in his capacity as Executive for JCS for civil affairs, advised the JCS that a review of the civil affairs planning contained in OPLAN 314/316 indicated "a major deficiency" in the occupation phase of operations. ] He therefore recommended that JCS authorize him to establish a Civil Affairs Special Planning Group immediately, in order to develop a complete and detailed civil affairs plan for military occupation of Cuba.<sup>1</sup> The JCS agreed, and the same day, in a staff memorandum to the Army Chief of Staff, they so directed.<sup>2</sup>

786. A week later, on 30 October, CINCLANT himself revised the civil affairs annex to his OPLAN 316. CINCLANT would retain overall jurisdiction for civil affairs activities, with CINCARLANT coordinating civil affairs planning and CJTF-Cuba, when activated, exercising civil affairs authority and responsibility under CINCLANT during actual operations.<sup>3</sup> But substantive civil affairs planning, largely because of a lack of known terms of reference, proceeded at a slow pace. Not until the middle of November did a draft JCS policy directive relative to the conduct of civil affairs administration in the postassault

<sup>1</sup>Memo, CSA to JCS, CSAM-359-62, "Immediate Establishment of a Civil Affairs Special Planning Group (U)," 21 Oct 62, Encl to JCS 2304/72, same subject, same date, TOP SECRET.

<sup>2</sup>Memo, JCS to CSA, SM-1196-62, "Immediate Establishment of a Civil Affairs Special Planning Group (U)," 21 Oct 62, TOP SECRET.

<sup>3</sup>Msg, CINCLANT to CINCARLANT, et al., DAIN 283146, 30 Oct 62, TOP SECRET.



TOP SECRET

and occupation phases undergo staffing, both intra-JCS and interagency, but it never did achieve an approved final form prior to the termination of the crisis.<sup>1</sup> Even force requirements in support of expected civil affairs activities connected with extended military occupation were not easily established. The JCS had requested estimates of such force requirements from CINCLANT well before the crisis, on 6 October,<sup>2</sup> and on 17 October CINCLANT submitted a partial list,<sup>3</sup> which was not approved by the JCS until 4 December,<sup>4</sup> along with JCS suggestions of additional force requirements.<sup>5</sup> By then, the question of military occupation of Cuba had been relegated by events into an academic issue.

787



<sup>1</sup>JCS 2304/107, 16 Nov 62, TOP SECRET.

<sup>2</sup>Msg, JCS 6581 to CINCLANT, 061510Z Oct 62, TOP SECRET.

<sup>3</sup>Msg, CINCLANT to JCS, 172046Z Oct 62, TOP SECRET.

<sup>4</sup>JCS 2018/522, 29 Nov 62 (Decision on 6 Dec 62), TOP SECRET.

<sup>5</sup>Msg, JCS 7728 to CINCLANT, et al., 061623Z Dec 62, TOP SECRET.

<sup>6</sup>CINCLANT reports cited in J-3 SITREP 8-62, JCS 7107 to DSTP Offutt AFB, et al., 300954Z Oct 62, TOP SECRET.

TOP SECRET

TOP SECRET

~~TOP SECRET~~

788.

789.

<sup>1</sup>Msg, JCS 7066 to CINCLANT (Info CINCARLANT and CINCAFLANT), 281607Z Oct 62, TOP SECRET.

<sup>2</sup>Msg, CG USCONARC/ARLANT to CINCLANT (Info JCS, CINCAFLANT, CINCLANTFLT), ATEOC-JR 302881, 292127Z Oct 62, TOP SECRET

<sup>3</sup>US/F Hq Historical Div Liaison Office, "Chronology of Air Force Actions During the Cuban Crisis: 14 October - 30 November 1962," Apr 63, TOP SECRET.

TOP SECRET

- 315 -

~~TOP SECRET~~

~~TOP SECRET~~

E

TOP SECRET

790

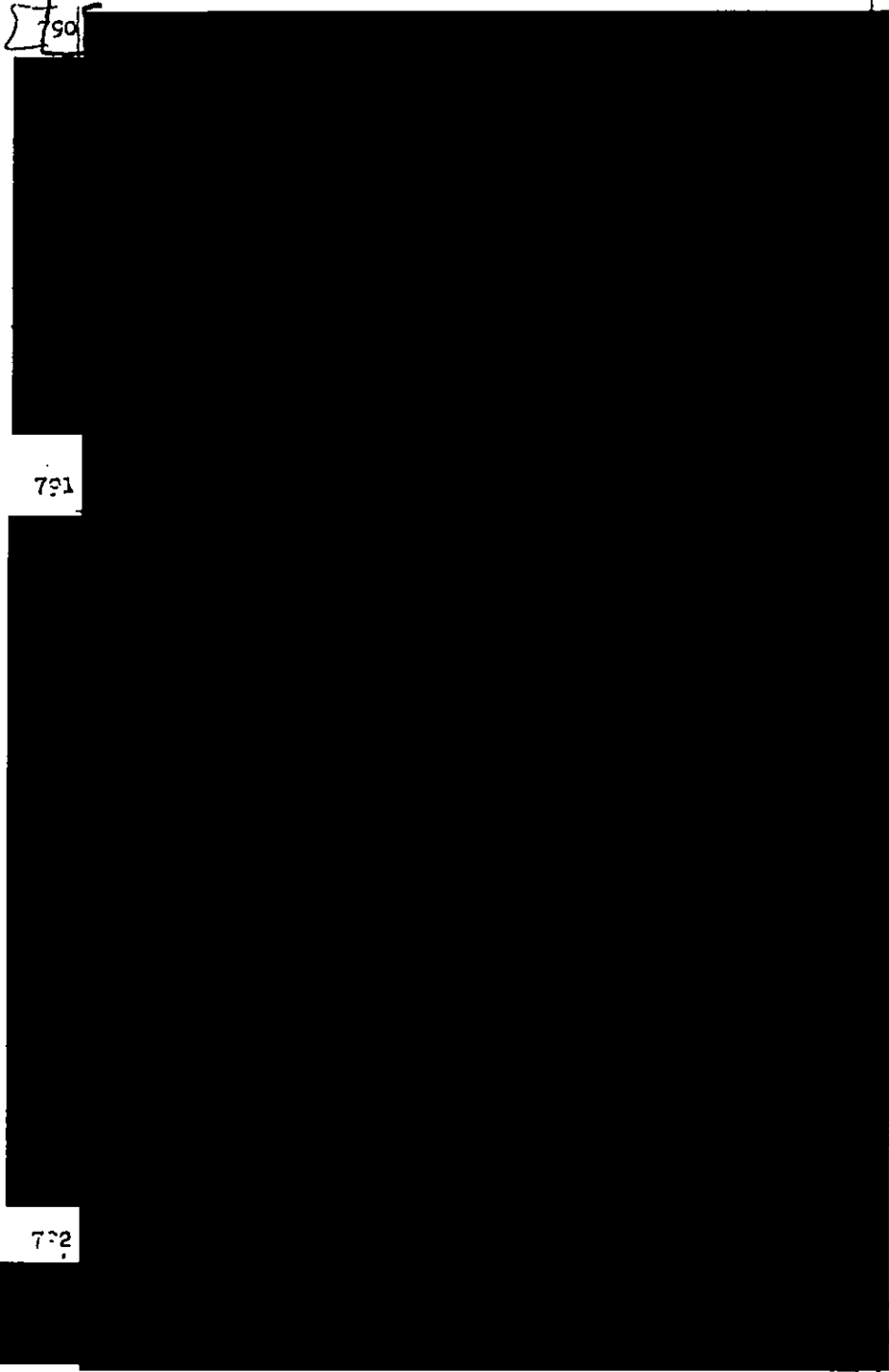

1A1

791

792

1. Msg, JCS 7166 to CINCLANT, 012312Z Nov 62, SECRET.

2. Msg, CINCLANT to JCS, 020415Z Nov 62. TOP SECRET.

TOP SECRET

- 315 -

~~TOP SECRET~~

E

TOP SECRET

~~TOP SECRET~~

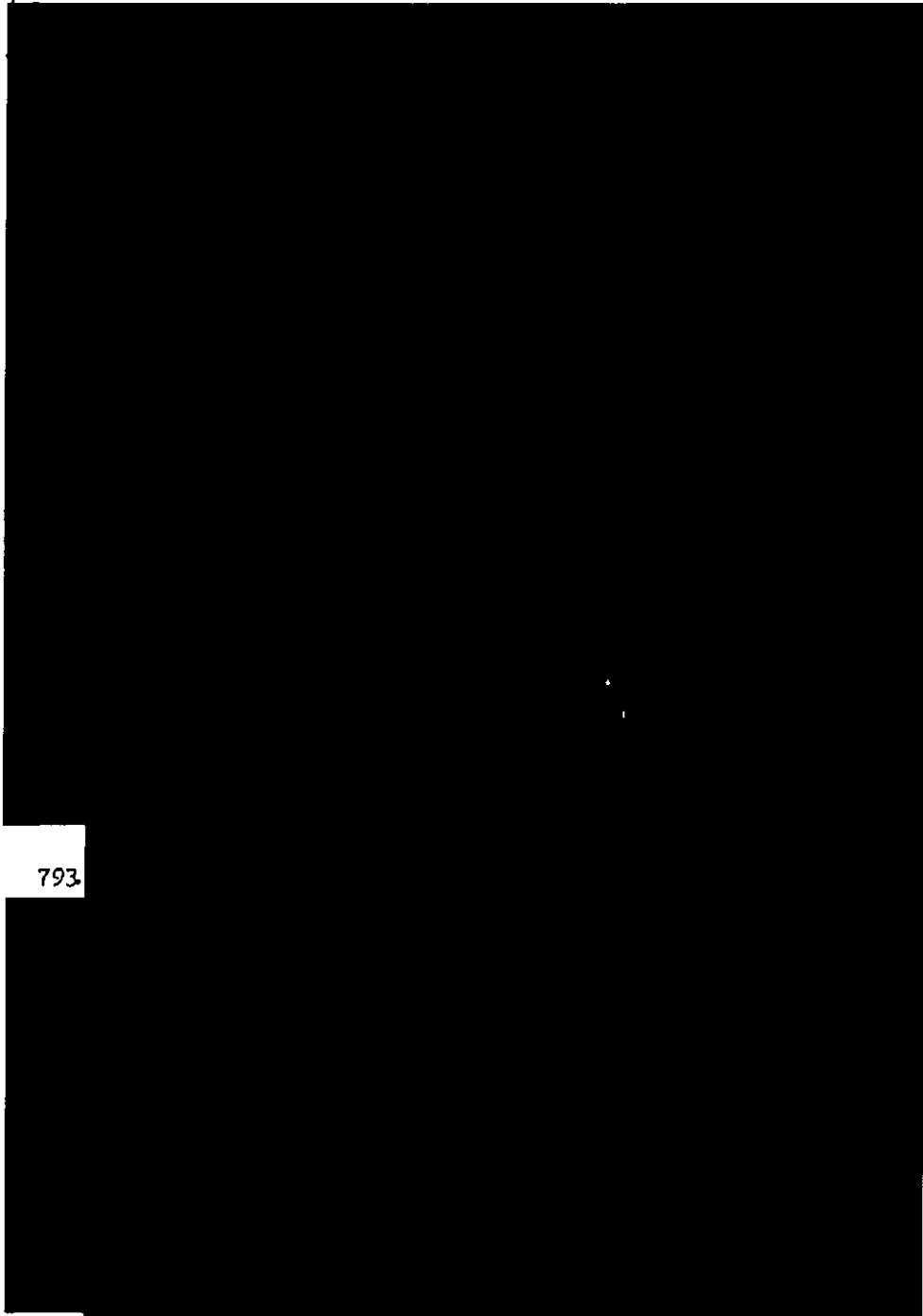

793

[Memo, CJCS to President, CM-85-62, "Evaluation of the Effect on U.S. Operational Plans of Soviet Army Equipment Introduced into Cuba," 2 Nov 62, TOP SECRET.]

TOP SECRET

- 317 -

~~TOP SECRET~~

TOP SECRET

~~TOP SECRET~~ E

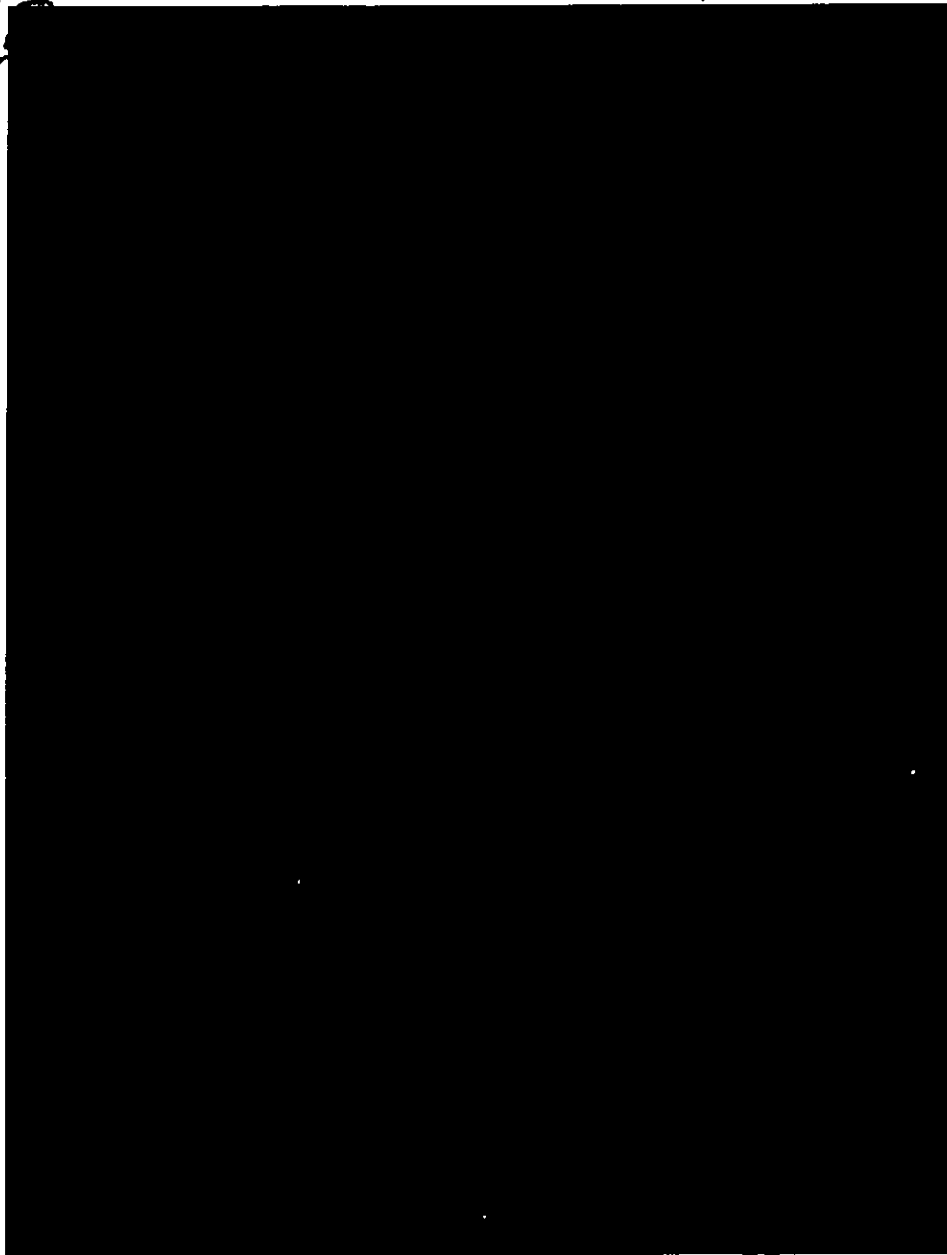

Msg, CINCLANT to JCS (Info CINCLANTFLT, CINCAFLANT, CINCARLANT),  
041532Z Nov 62, TOP SECRET. Ji

TOP SECRET

- 318 -

~~TOP SECRET~~

TOP SECRET

TOP ~~SECRET~~

794.

795. Relatively late in the crisis, about the middle of November, the JCS in reviewing Annex Y (Unconventional Warfare) to OPLAN 316 (also the applicable UW Annex for 312), observed that it only provided for UW operations complementary to and in direct support of overt conventional attack by major U.S. forces. Possible opportunities for UW operations presented by contingency situations prior to or unrelated to such attack were not covered. On 16 November, the JCS therefore directed CINCLANT to develop UW plans of two types for covert support of internal uprisings in Cuba:

a. On the basis of the covertly supported uprisings being followed by overt commitment of conventional U.S. forces, as required, to exploit any success achieved,

b. On the basis of no overt commitment of conventional U.S. forces.<sup>1</sup>

COMJUNTFEA was still in the process of developing the required new UW plans when the crisis, shortly after, began to show signs of having run its course. The prospects of operations such as those contemplated diminished accordingly.

796 Other important amendments to invasion planning provisions were also effected in regard to reaction times and force levels. These are treated separately in the next two sections.

Msg, JCS 7414 to CINCLANT, 151607Z Nov 62, TOP SECRET

TOP SECRET

- 31 -

TOP ~~SECRET~~

~~TOP SECRET~~

TOP SECRET

#### 4. ESTABLISHING REACTION TIMES

757. Probably the greatest single source of perturbation as far as contingency military plans were concerned was reaction times. As before the crisis, the President and Secretary of Defense continued to lay on requirements demanding rigid operational adherence to austere reaction-time criteria. From a strategic point of view, the element of tactical surprise as to the nature and timing of any military action was seen as crucial. Paramount, of course, was the overriding fear of escalation, but another rationale also was evident. Discretionary selection from a range of predetermined kinds of military moves, in conjunction with quick execution of the particular course of action chosen, offered a potential technique for controlling in some measure the character of the crisis, containing it within manageable bounds, and ultimately winning maximum policy gains with minimum expenditure of military effort -- and the least risk. The national decision regarding the U.S. response to the crisis hinged on the application of military force subordinate to and directly in support of the primary political maneuvers that were being employed to resolve the military issue at the root of the crisis. Hence, placing the burden of responsiveness in meeting short reaction times on the military establishment in effect enhanced the flexibility of national political decision making. The degree to which this was carried in the case of the Cuban crisis represents an innovation.

798 [One of the first problems involving reaction times was in connection with OPLAN 312-62, the air-strike plan. It emerged as a result of unforeseen operational consequences attending preparations to implement the 312 plan. By 22 October, the heavy concentration of aircraft at Homestead and Key West posed an inviting vulnerability that gave JCS pause for concern. But the ]

TOP SECRET

- 320 -

~~TOP SECRET~~

TOP SECRET

~~TOP SECRET~~

[Price of reducing the concentration by withdrawing some of the aircraft from forward deployment was inversely proportionate to the lead time required for implementing the air-strike plan. The JCS was inclined in favor of caution, and on 22 October CINCLANT was therefore authorized to reduce his readiness posture to execute OPLAN 312 from the then prevailing 6-hour reaction time to a 12-hour reaction time, in order to permit dispersing of aircraft if he so chose.

799. Although both CINCAFLANT and CINCLANT questioned the advisability of dispersal,<sup>1</sup> concern over aircraft concentration nevertheless continued, and on 24 October the Chairman, JCS, requested CINCLANT to consider the feasibility of dispersing half the aircraft but without affecting the 12-hour reaction time. The Chairman's query was confirmed the same day in a JCS message formally requesting CINCLANT's estimate of the impact on his 12-hour readiness capability to implement OPLAN 312 if his presently deployed forces in forward areas were reduced by 50 percent.<sup>2</sup> CINCLANT replied early the next morning, again strongly objecting to the proposal, stating that such a reduction would seriously degrade his readiness capability to meet the 12-hour reaction time.<sup>3</sup> CINCLANT remained adamant, reiterating his position the next day and again on 27 October, even to the extent of implying that under such a handicap he might not be able to fulfill the air-strike mission regardless of time frame.<sup>4</sup> The upshot was that such large-scale dispersal was not put into effect and the 12-hour reaction time for OPLAN 312 was retained until the crisis began to unwind. In the interim, of course, ]

<sup>1</sup>Msg, CINCLANT to JCS, 222150Z Oct 62, TOP SECRET.

<sup>2</sup>Msg, JCS 6963 to CINCLANT (Info CINCAFLANT), 250026Z Oct 62, TOP SECRET.

<sup>3</sup>Msg, CINCLANT to JCS, 251000Z Oct 62, TOP SECRET.

<sup>4</sup>Msgs, CINCLANT to JCS, 260450Z and 270250Z Oct 62, TOP SECRET.

TOP SECRET

- 321 -

~~TOP SECRET~~



TOP SECRET

~~TOP SECRET~~

[the special subplans of OPLAN 312 discussed earlier had been evolving, some of them providing for reaction time considerably shorter than 12 hours.

800. Meanwhile, a different kind of problem with reaction times was also occurring in connection with the invasion plan. It will be recalled that early in the crisis, on 17 and 18 October, the concept of OPLAN 316 had been altered to provide for simultaneous airborne and amphibious assaults, along with a general beefing-up of the initial assault force. Apparently it was understood by JCS and LANTCOM line commanders that the new concept was to be cast in an extended time frame of seven-day reaction rather than five. The Service technical staffs seem also to have understood this clearly enough, for on 23 October the Office of the Chief of Transportation had pointed out to the Army War Room that the existing Annex M (Transportation) to OPLAN 316 was outdated by virtue of having been based on a five-day reaction time, whereas current transportation planning now in progress was being oriented to a seven-day reaction time.<sup>1</sup> However, CINCLANT planners and the staffs of subordinate field forces were not fully aware of the new seven-day frame. Certainly, staffs were at least confused on this score, as demonstrated by events described below.]

901 By 24 October the President (and U.S. Secretary of Defense as well) apparently was also somewhat confused about the various reaction times for the several optional courses of military action then under consideration, and desired clarification.<sup>2</sup>

<sup>1</sup>DA ODCSOPS Army War Room Journal (Cuban Crisis), TOP SECRET.

<sup>2</sup>JCS 2304/83, 25 Oct 62 (Decision on, same date), TOP SECRET.

TOP SECRET

~~TOP SECRET~~

~~TOP SECRET~~

TOP SECRET

The next day, 25 October, the JCS responded, through the Secretary of Defense, to the President's request with a compendium recapitulating the range of options and the respective reaction times for each. They stated that "in order to assure understanding of the timing factors which govern the implementation of military actions related to Cuba," the lead-time required from receipt of an execution order to the actual initiation of the operation ordered was as follows:

a. Low-level reconnaissance of selected targets: reaction time - two hours.

b. Reprisal strike on a single SA-2 site (Special Plan FIRE HOSE): reaction time - two hours.

c. Air strikes against all SA-2 sites (later identified as FULL HOUSE): reaction time - two hours (contingent upon being able to maintain present readiness posture).

d. Full air strikes against Cuban military targets (total OPLAN 312, later identified as RED BLUFF): reaction time - 12 hours.

e. Invasion of Cuba (OPLAN 316): reaction time - initial assaults to commence 7 days after a decision to implement the plan, with all assault and essential support forces ashore within 18 days after the decision (perhaps sooner).

They further advised that invasion planning was concentrating on OPLAN 316 based on a seven-day reaction time; the seven days required to implement it would be utilized for necessary neutralization or elimination of hostile air and ground capability, to which airborne assault forces especially would be vulnerable while in flight.<sup>1</sup>

<sup>1</sup>Memo, JCS to SecDef, JCSM-821-62, "Timing Factors," 25 Oct 62, TOP SECRET.

TOP SECRET

~~TOP SECRET~~

~~TOP SECRET~~

TOP SECRET

802. Two days later, on 27 October, the Chairman, JCS, relayed the text of the above "Timing Factors" compendium in its entirety to CINCLANT in an "Exclusive" message for Admiral Dennison alone, advising the Admiral that "these reaction times have been given to the President as to what he may expect."<sup>1</sup> A week later, on 4 November, the JCS reiterated that these established reaction times "may not be modified except upon JCS recommendation to and approval by higher authority."<sup>2</sup> The Chairman's 27 October message to CINCLANT should have settled some of the outstanding problems regarding reaction times, but did not.

803. [Despite the codification of "established reaction times" at the JCS level, staff planners at the LANTCOM level and below still labored under an ambivalent five-day/seven-day frame of reference for invasion planning. On 26 October, CG XVIII Airborne Corps called to the attention of CINCARLANT that the posture of Army forces for OPLAN 316 was not oriented to either five- or seven-day reaction time, as some references seemed to indicate, but rather was based on a seven-day reaction time plan only.<sup>3</sup> Whereupon CINCARLANT, as CGUSCONARC, apprized the Army Deputy Chief of Staff for Operations of the five-day vs. seven-day problem. He stated that he had requested an estimate from CINCAFLANT regarding the length of time it would take to complete air preparations for implementation of OPLAN 316, to which CINCAFLANT had replied that he could not commit himself to a set time frame but that he opposed any shortening of the ]

<sup>1</sup>Msg, JCS 7044 to CINCLANT (JCS EXCLUSIVE for Dennison), 271359Z Oct 62, TOP SECRET.

<sup>2</sup>Msg, JCS 7227 to CINCLANT (Info CINCAFLANT et al.), 050245Z Nov 62, TOP SECRET.

<sup>3</sup>Msg, CG XVIII Corps to CINCARLANT et al., 262025Z Oct 62, TOP SECRET.

TOP SECRET

- 324 -

~~TOP SECRET~~

~~TOP SECRET~~

TOP SECRET

Seven-day period between the commencing of air preparations and the D-day assaults. CGUSCONARC advised that he concurred that a seven-day lead time was a tactical necessity.<sup>1</sup>

804. CINCARLANT and CINCLANT staff planners, meanwhile, turned to the JCS for a ruling to resolve the ambiguity. On the same day, 27 October, confirmation was requested of JCS as to whether OPLAN 316 was now the invasion plan, rather than OPLAN 314, and whether it was the seven-day version of OPLAN 316, rather than the five-day. CINCLANT - i.e., his staff - pointed out that planning for the seven-day version was reasonably complete, whereas an entire recomputation of movement tables would be necessary for a five-day version.<sup>2</sup>

805. At JCS, the Joint Battle Staff, in processing the message above, noted that the Chairman's Exclusive message (JCS 7044) to Admiral Dennison earlier than same day (27 October) had already answered the query regarding the seven-day version of OPLAN 316, but being an "Exclusive" obviously had been closely held and not distributed by CINCLANT to his staff. It was fully a day later, at 1800 hours on 28 October, that the JCS confirmed by secure telephone (KY-9) that the seven-day version of OPLAN 316 was indeed the only currently applicable invasion plan.<sup>3</sup> Thus, some 26 hours had elapsed before the LANTCOM staff's confusion on this point was cleared up.

806. Thereafter, there appeared to be no further question from any quarter that the Cuban Invasion plan was CINCLANT OPLAN 316-62 with a seven-day reaction time.]

<sup>1</sup>DA ODCSOPS Army War Room Journal (Cuban Crisis), TOP SECRET.

<sup>2</sup>Msg, CINCLANT to JCS, 272014Z Oct 62, TOP SECRET.

<sup>3</sup>Handwritten marginal annotations entered on JCS hard copy of subject message (CINCLANT 272014Z Oct 62, TOP SECRET)

TOP SECRET

- 325 -

~~TOP SECRET~~

TOP SECRET

~~TOP SECRET~~

807. [The problem of reaction times for OPLAN 312, the air-strike plan, however, was not yet completely settled. On 28 October, and again on 4 November, CINCLANT had informed the JCS of his SHOE BLACK option of 312 (wider range of selective air strikes according to type of target, including SAM sites) as having a reaction time "from within two hours to six hours . . . depending on scale of operations directed."<sup>1</sup> Late on 4 November, the JCS demurred with respect to CINCLANT's flexible two- to six-hour reaction time for SHOE BLACK. The JCS advised that SHOE BLACK and FIRE HOSE (air strike on a single SAM site) as set forth by CINCLANT were "not amenable to precise correlation with targeting as set forth in the established reaction times for Cuban contingency plans given to the Secretary of Defense and the President" on 25 October (see above). However, modification of alert posture would be permitted at CINCLANT's discretion, providing the specified two-hour reaction time were maintained for JCS-designated targets, i.e., SAM sites.<sup>2</sup> Early the next morning (5 November), CINCLANT amended the reaction times accordingly, directing that FIRE HOSE and FULL HOUSE (a single SA-2 site and all SAM sites, respectively) both be two-hour reaction time, while SHOE BLACK would not include SAM sites and would have a fixed reaction time of six hours.<sup>3</sup> ]

808. [There was also a technical difficulty, expressly of a command and control nature, experienced in connection with reaction times, especially with OPLAN 312. CINCLANT had recommended to the JCS on 28 October that an execution message for OPLANS 312 and 316 be prepositioned with him so as to permit ]

<sup>1</sup>Msgs, CINCLANT to JCS et al., 281540Z Oct and 042010Z Nov 62, TOP SECRET.

<sup>2</sup>Msg, JCS 7227 to CINCLANT (Info CINCAFLANT et al.), 050245Z Nov 62, TOP SECRET.

<sup>3</sup>Msg, CINCLANT to CINCAFLANT et al. (Info JCS), 050905Z Nov 62, TOP SECRET.

TOP SECRET

- 326 -

~~TOP SECRET~~

TOP SECRET

~~TOP SECRET~~

Instant transmitting of the actual order to implement the plans via insecure voice channels.<sup>1</sup> On 31 October, the JCS complied by sending the requested prepositioned execution message.



809



<sup>1</sup>Msz, CINCLANT to JCS, 282510Z Oct 62, TOP SECRET.

<sup>2</sup>Msz, JCS 7131 to CINCLANT, 311404Z Oct 62, TOP SECRET.

TOP SECRET

- 327 -

~~TOP SECRET~~



810



811. [The JCS, on receipt of CINCLANT's message immediately repeated it "Operational Immediate" to the White House (022232Z November). The next day, 3 November, the JCS, responding to CINCLANT's recommendations of the day before, cancelled JCS 7131.]

[Mss. CINCLANT to JCS (Info CINCPACFLT) 021852Z Nov 62, TOP SECRET]  
Ibid.

TOP SECRET

~~TOP SECRET~~

[REDACTED]

812. Well after the urgency of the immediate military situation had been abated and the crisis was to all practical purposes over, the issue of reaction times was once again revived. Apparently the President was dissatisfied with the best reaction-time readiness posture that the military establishment had been able to achieve during the height of the crisis. On 27 November he directed the Chairman, JCS, to have the JCS undertake a review of all Cuban contingency plans in order to determine ways and means of compressing reaction times.<sup>2</sup> The same day, the Chairman formally instructed the Director, Joint Staff, to prepare a directive to CINCLANT to provide data for appropriate JCS response to the President.<sup>3</sup> J-3 drafted the required message to CINCLANT which was approved by the JCS and sent on 28 November.<sup>4</sup> CINCLANT was directed to review his Cuban contingency plans and advise JCS of possible modifications for reducing reaction times.<sup>5</sup> But by this time, 28 November, the whole issue of reaction times was no longer of more than academic relevance to the current Cuban crisis, inasmuch as a general stand-down in readiness posture of forces had already gone into effect and many units were preparing for or were in the process of, redeployment back to their home stations.

<sup>1</sup>Msg, JCS 7212 to CINCLANT et al., 031559Z Nov 62, TOP SECRET.

<sup>2</sup>JCS 2018/520, 27 Nov 62, TOP SECRET.

<sup>3</sup>Memo, CJCS to DJS, CM-139-62, "Review of CINCLANT 312, 314, and 316," 27 Nov 62, TOP SECRET.

<sup>4</sup>JCS 2018/521, 27 Nov 62 (Decision on, 29 Nov 62), TOP SECRET

<sup>5</sup>Msg, JCS 7570 to CINCLANT, 28 Nov 62, TOP SECRET.

TOP SECRET

- 329 -

~~TOP SECRET~~



I. PROVIDING FOR ADEQUATE FORCE LEVELS

813. An important factor also causing readjustments reflected in changes to contingency plans was force-level commitments. Generally through the crisis the trend was upward, with an increase in size of forces both for OPLANS 312 and 316.

814. [ As early as 21 October a substantial addition was made to the planned invasion force. CINCLANT had actually requested the increase almost a month and a half before the crisis, on 9 September, but a decision had not been rendered until now. JCS acceded to CINCLANT's request and approved an added provisional infantry brigade, consisting of two battle groups, for OPLAN 316 forces.<sup>1</sup> The planned troop list was changed accordingly.

815. Over the next three days the scheduled phasing of forces for OPLAN 315 was rearranged in order to provide for maximum combat strength to be brought to bear as soon as possible in the initial assault. On 25 October, CINCLANT, noting the extent to which the initial assault force had already been increased, advised the JCS that three additional infantry battle groups, over and above the force already planned, could now be air-landed on D-day with the XVIII Airborne Corps assault waves. He proposed that OPLAN 315 be changed accordingly.<sup>2</sup> The next day (25 October) CG XVIII Airborne Corps, as soon as he became aware of CINCLANT's proposal, called CINCARLANT's attention to the fact that the three additional battle groups could not begin arriving in the objective area until D-2, and not all be air-landed on D-day as CINCLANT thought.<sup>3</sup> A day later, on 27 October, CINCLANT ]

<sup>1</sup>Msg. CINCLANT to JCS, 091349Z Sep 62; JCS 6821 to CINCLANT, CINCSTRIKE et al., 210704Z Oct 62, TOP SECRET.

<sup>2</sup>Msg. CINCLANT to CINCARLANT and CINCAFLANT (Info JCS), 260320Z Oct 62, TOP SECRET.

<sup>3</sup>Msg. CG XVIII Aon Corps to CINCARLANT et al., 262025Z Oct 62, TOP SECRET.

TOP SECRET

~~TOP SECRET~~

Rectified the error, informing JCS that it was not possible to bring in the additional forces on D-day as he had reported.<sup>1</sup>

816. Meanwhile, more and more Air Force units for both invasion operations and air strikes were being involved in contingency preparations, either to meet new requirements laid on (such as separate forces for FIRE HOSE) or as a voluntary safety-margin augmentation. Late on 3 November CINCLANT advised the JCS that the total of TAC fighters and troop carrier aircraft now deployed and committed for Cuban operations was considerably in excess of authorized force levels as provided for in OPLANS 312-62 and 316-62. These levels, originally approved in 1961, had been based on the enemy situation as it existed at the time. Progressively since then, the Soviet build-up of Cuban military armaments required proportionate increases in USAF forces to match the improving Cuban capability. By now this increase in allocated USAF forces amounted to the full CONUS resources of TAC. CINCLANT admitted that this might pose problems if a concurrent contingency arose requiring reinforcement of CINCEUR or CINCARIB, but urged that such a "remote possibility" should not prevent allocation of sufficient forces to meet the immediate needs of Cuban operations. Any reduction in these forces "will seriously degrade CINCLANT's ability to carry out mission."<sup>2</sup>

817. CINCLANT then explained that JCS approval of his concept of operations for employment of forces, as well as added requirements placed on him at JCS direction, were considered to have constituted approval for the allocation of these additional forces. Nevertheless, formal JCS confirmation would be desirable.

<sup>1</sup>Msg, CINCLANT to JCS, 272014Z Oct 62, TOP SECRET.

<sup>2</sup>Msg, CINCLANT to JCS, 040422Z Nov 62, TOP SECRET.

TOP SECRET

- 531 -

~~TOP SECRET~~

TOP SECRET

~~TOP SECRET~~

Therefore, CINCLANT requested that the presently programmed USAF forces for Cuban operations be so confirmed and that appropriate changes in plans be approved as follows:

a. [CINCLANT OPLAN 312-62: amend the original provisions for 17 TAC fighter squadrons to 19; amend the 2-1/3 reconnaissance squadrons to 3-1/2.

b. CINCLANT OPLAN 316-62: amend the original provisions for 14 Air Force Reserve C-119 troop carrier squadrons to 21; amend the 5 C-130 troop carrier squadrons to 7; raise the 17 TAC fighter squadrons to 19 and the 2-1/3 reconnaissance squadrons to 3-1/2, as for OPLAN 312; add a new provision for 2 air refueling squadrons.]

818. The following day, 5 November, JCS confirmed the USAF force level allocated to Cuban contingency operations, as requested, and approved the making of appropriate changes in OPLAN 312 and 316 to reflect this force commitment accordingly. The JCS reserved the right, however, to reallocate and redeploy these forces if contingencies elsewhere so required.<sup>2</sup> On 7 November, CINCLANT, in separate actions, formally promulgated Change No. 6 to CINCLANT OPLAN 316-62 and Change No. 6 to CINCLANT OPLAN 312-62 containing the necessary modifications.<sup>3</sup>

819. [Perhaps the most significant development with regard to planned force levels occurred on 5 November. Despite the considered professional military view submitted by the JCS to the President the preceding 2 November, that U.S. invasion plans were adequate in concept and means (see above), both the President

<sup>1</sup>Msg, CINCLANT to JCS, 040422Z Nov 62, TOP SECRET.

<sup>2</sup>Msg, JCS 7240 to CINCLANT (Info CSAF et al), 052304Z Nov 62, TOP SECRET.

<sup>3</sup>Msgs CINCLANT to CINCLANT et al, C70014Z and C70016Z Nov 62, TOP SECRET.]

TOP SECRET

- 332 -

~~TOP SECRET~~

TOP SECRET

~~TOP SECRET~~

[ and his civilian advisers still felt unsure. Disconcerting echoes of the lessons learned from the Bay of Pigs experience, and the consequent determination at that time that any future invasion be based on the use of "overwhelming force," were once again uncomfortably poignant.

820. [ In a memorandum to the Chairman, JCS, the Secretary of Defense conveyed this feeling of concern over the adequacy of ground forces available for invasion operations. Stating "CINCLANT OPLAN 316 seems thin," the Secretary felt that with the forces presently provided for "we could end up bogged down," because of the size of the problem, enemy equipment, and nationalist fervor of the resistance with which U.S. forces might have to contend; he drew analogies to the experience of the British in the Boer War, the Russians in the Finnish War, and the U.S. in the Korean War. The Secretary, therefore, proposed augmenting 316 forces. Specifically, he wanted more forces from the remaining three divisions that were being held in reserve in COMUS to be committed to the invasion plans, which would be replaced by National Guard divisions called up to reconstitute the strategic reserve. He requested JCS recommendations regarding the number of divisions that should be included in CINCLANT OPLAN 316-62, the number that the COMUS reserve should consist of and the number that should be called to active duty from the National Guard.<sup>1</sup> That same day the JCS accordingly instructed CINCLANT, CINCARLANT, CINCAFLANT, and other CINCS and commands to come to a meeting in Washington on Wednesday, 7 November to discuss these proposals of the Secretary of Defense.<sup>2</sup> ]

<sup>1</sup>Memo, SecDef to CJCS, "Additional Forces for CINCLANT OPLAN 316-62 (U)," 5 Nov 62, TOP SECRET.

<sup>2</sup>Hsg, JCS 7236 to CINCLANT et al., 051656Z Nov 62, TOP SECRET.

TOP SECRET

- 333 -

~~TOP SECRET~~

380

TOP SECRET

~~TOP SECRET~~

321. On 7 November, the JCS held the Washington conference, attended by CINCLANT, CINCSAC, CINCONAD, CINCSTRIKE, CINCARLANT, CINCAFLANT, COMATS, and other interested commands or their representatives, to consider the problem of augmentation. It was concluded that the only possible source of augmentation forces was the 5th Infantry Division (Mechanized), part of the 2nd Armored Division, and two more Marine infantry battalions from the 1st Marine Division on the West Coast. The 4th Infantry division, and the rest of the 2nd Armored Division itself, were excluded from consideration inasmuch as a major portion of their combat equipment was prepositioned in Europe for CINCEUR's augmentation requirements. [It was also agreed that augmentation forces available from the two divisions could not be used to increase the weight of the initial assault force,

[redacted] would be saturated; therefore they would have to be follow-on forces or part of the Floating Reserve.] However, it was noted that the two additional Marine infantry battalions from the West Coast could be used to replace the 5th MEB as Guantanamo reinforcement, thereby releasing the 5th MEB for over-the-beach operations (later the two West Coast Marine units were deleted without affecting the new 5th MEB mission). The use of National Guard divisions to reconstitute the CONUS reserve was considered impractical, in the light of training and equipment problems, but their possible use for occupation duty seemed feasible.<sup>1</sup> As a result of the meeting, CINCLANT was directed to prepare by 10 November an outline plan providing for employment of such augmentation forces over and above forces presently programmed for inclusion in OPLAN 316-62.<sup>2</sup>

<sup>1</sup>Hemo for Record (J-3), JCS meeting with CINCLANT et al., 7 Nov 62, TOP SECRET.

<sup>2</sup>JCS 2018/511, 13 Nov 62, TOP SECRET.

TOP SECRET

- 334 -

~~TOP SECRET~~

TOP SECRET

~~TOP SECRET~~

822. The day following the meeting, on 8 November, CGUSCONARC, acting on advice from the Army Chief of Staff, informed the commanders of each CONUS Army -- somewhat prematurely -- that the 5th Infantry Division (Mechanized) and the 2nd Armored Division had been committed to augment CINCLANT OPLAN 316 forces.<sup>1</sup> A retraction was issued the next day, 9 November, when CGUSCONARC cancelled his 8 November message.<sup>2</sup> The augmentation referred to was still in the proposal stage and no decision on it had yet been made.

823. On 10 November, CINCLANT submitted to the JCS the requested outline plan for employment of the augmentation forces discussed at the JCS-convened meeting of 7 November. Based on the guidelines then laid out, the outline plan, identified as CINCLANT OPLAN 316-52 (Augmented), provided for the original concept of operations to be retained in its present form except for the added forces, and contemplated using National Guard forces for postcombat occupation duty to relieve regular assault forces, who could then return to CONUS reserve status. The JCS tentatively adopted the outline as a basis for preparing their response to the Secretary of Defense's query of 5 November.<sup>3</sup>

824. A few days later, on 16 November, CINCLANT, in an unrelated matter, requested JCS to authorize immediate movement of two more Marine battalion landing teams (BLT's) of the 1st Marine Division from the Pacific Coast in order to augment further the defense of Guantanamo.<sup>4</sup> CINCLANT's request was disapproved on 24 November, the JCS advising him that further reinforcement of Guantanamo was

<sup>1</sup>Msg. CGUSCONARC to First Army et al., 082330Z Nov 62, TOP SECRET.  
DA ODCSOPS Army War Room Journal (Cuban Crisis), TOP SECRET.

<sup>2</sup>Msg. CG USCONARC to First Army et al., 091415Z Nov 62, TOP SECRET.

<sup>3</sup>CS 2018/511, 13 Nov 62, TOP SECRET.

<sup>4</sup>Msg. CINCLANT to JCS, 161413Z Nov 62, TOP SECRET; see also  
CS 7366 to CINCPAC, 121402Z Nov 62, TOP SECRET.

TOP SECRET

- 335 -

~~TOP SECRET~~

TOP SECRET

~~TOP SECRET~~

not required at that time and, moreover, that under any circumstances Guantanamo reinforcement should not be with BLTs. [The JCS directed CINCLANT, therefore, to modify his OPLAN 316-62 to reflect the above concept, so as to provide now for reinforcing Guantanamo by forces other than the 5th MEB, when and if needed, and gave the 5th MEB for over-the-beach operations in Western Cuba.]

825 Meanwhile, on 20 November, the JCS responded to the Secretary of Defense's memorandum of 5 November that had initially raised the augmentation issue. [They advised him that upon reviewing the 316 invasion plan they had concluded that the forces currently provided for therein were "probably adequate" to achieve U.S. national objectives in Cuba, but they also agreed "it would be prudent" to earmark additional forces as a ready reserve for the operation if needed. Explaining that some of the existing CONUS strategic reserve resources had to be ruled out (citing the 4th Infantry Division and part of the 2nd Armored Division, with the reasons therefor), the JCS recommended that the 5th Infantry Division (Mechanized) and a combat command of the 2nd Armored Division, along with supporting forces, be committed to CINCLANT OPLAN 316-62 augmentation, but that no movement from home stations be undertaken until directed by JCS. They also pointed out that, in addition, the 5th MEB now in the Caribbean, with a strength of approximately 9,000, would be available for invasion assault operations rather than for Guantanamo defense.]

826 With respect to the proposed use of National Guard forces, the JCS recommended to the Secretary that, although the augmenting of OPLAN 316 forces would virtually deplete the CONUS strategic

<sup>1</sup>Msg, JCS 7548 to CINCLANT, 242115Z Nov 62, TOP SECRET.

<sup>2</sup>Memo, JCS to SecDef, JCSM-913-62, "Additional Forces for CINCLANT OPLAN 316-62 (U)," 20 Nov 62, TOP SECRET.

TOP SECRET

- 335 -

~~TOP SECRET~~

TOP SECRET

~~TOP SECRET~~

reserve, no National Guard divisions should be called to active duty to reconstitute it; in any event only one National Guard division could be combat-equipped from resources available in CONUS. [Instead, they recommended that two National Guard divisions for occupation duty be alerted when OPLAN 316 was implemented and that the timing of their actual mobilization be phased according to the progress of combat operations in Cuba. Finally, the JCS advised the Secretary that the increased Army and Marine forces would require considerable additional lift capacity, specifically 16 more transports, 68 cargo ships and 11 LSTs. They therefore recommended that measures be taken to insure the availability of the transport and cargo ships when needed, but that the LSTs be obtained immediately by reactivating 11 of them from the Reserve Fleet.]

827. This marked the high-water mark in the force-level commitment for planned Cuban operations. [It had practically exhausted the CONUS-based strategic reserve, leaving a residual force of only 1-2/3 Army divisions, which were themselves already precommitted to fill other contingency requirements elsewhere. TAC resources in CONUS were even more fully committed, while the Marine Corps was down to little more than the training battalions at its East and West Coast bases. Shortly, however, before the augmentation could be formalized such beyond "air-marking," or before the units involved could be operationally affected to any great extent, the whole problem of force-level considerations was overtaken by events.] By the latter part of November the military urgency of the crisis had ebbed, readiness posture was already being relaxed, and the likelihood of launching an invasion receding.

---

1 Memo, JCS to SecDef, JCSM-913-52, "Additional Forces for CINCLANT OPLAN 316-52 (U)," 20 Nov 62, TOP SECRET.

TOP SECRET

- 337 -

~~TOP SECRET~~



TOP SECRET

~~TOP SECRET~~

J. SUMMARY OBSERVATIONS

828. Contingency planning addressed itself to only one of the military dimensions of the Cuban crisis. Overshadowing, in one respect, were the more serious competing demands of the general war dimension affecting generation of SIOP forces, and in another, the actual quarantine operations that were carried out in conjunction with diplomatic measures; in a sense, even defense of territorial CONUS had precedence. Nevertheless, because the contingency plans pertained to the immediate issue and locus of the situation around which the entire crisis revolved -- i.e., presence of the offensive threat on the island of Cuba -- they were central to the total U.S. response. Preoccupied with them, accordingly, were the civilian national decision-making authority, higher military command echelons, and a major portion of the operational forces of the military establishment that would be affected.

829. Fundamentally, the contingency plans constituted at once a technique and an instrument of command and control for generating, bringing into rational concert, and regulating the synthesis of all of the myriad elements organic to an enterprise of such magnitude and complexity as military action against Cuba. Throughout, the emphasis on command and control was a dominant and pervasive influence. Derived in the first instance from the larger strategic purpose and context of the plans as a whole, it impinged upon and was reflected in the plans directly, setting in motion much of the planning activity, defining the character of what would be done, determining how, by whom, and when, and even stipulating the content of many of the provisions. Demonstrated in the experience, moreover, were command and control phenomena unique to the contingency planning function itself.

TOP SECRET

- 338 -

~~TOP SECRET~~

~~TOP SECRET~~

TOP SECRET

830. Contingency planning witnessed no abrupt break or sudden metamorphosis in character following the aerial reconnaissance photographs of 14 October that precipitated the crisis. The planning that had been undertaken prior to the crisis and the planning that went on during it proved to be of one continuum. Indeed there were radical substantive departures in certain regards, both in the form of revisions and additions, but essentially the same conceptual approach was retained as before. Planning continued to be in terms of two types of contingency operations -- air strikes and invasion. Whatever extensive modification did occur, moreover, was made incrementally over time. The significant difference was in degree rather than in kind. It was manifest in the accelerated pace of planning under the compelling urgency of the situation at hand, and in the multiplicity and variety of alterations that concrete military circumstances or the subtle complexities of policy and strategy considerations required.

831. The dominant factors shaping the character of contingency plans were:

- a. Military assessments of the intrinsic military situation in Cuba,
- b. Civilian decision makers' appraisals of the Cuban military situation and evaluations of its operational significance,
- c. Policy and strategy requirements, as interpreted by the national decision-making authority, and
- d. Finite limits to the military resources and capabilities effectively available for Cuban operations.

The fluctuating interplay among these four factors, since the relative weight of each varied at different times, might itself be considered an additional factor influencing contingency planning.

TOP SECRET

- 339 -

~~TOP SECRET~~

823. The two contingency plans that became the applicable ones were not in an approved status when the crisis first broke. The basic plan governing air-strike operations was approved relatively quickly, but settling upon a basic operational plan for invasion and getting it approved was a time-consuming process. In the interim, the absence of, or ambivalence in, key planning terms of reference resulted in considerable confusion.

833. In part, the difficulty lay in the functioning of the contingency planning system itself, which made for an element of built-in ambiguity. Approval seemed to be a random process. There were no unequivocal criteria for determining whether a planning item was approved or not. A given basic plan -- or a component -- could officially be in existence on one of four different levels of approval:

- a. Approved as a "concept" of a proposed plan.
- b. Approved as an "outline plan."
- c. Approved "for planning purposes only."
- d. Approved as an "operation plan" for implementation when directed.

The plans, or individual portions of them, did not necessarily have to go through each of these four stages in sequence. Throughout the crisis, various parts of the contingency air-strike and invasion plans enjoyed one or another of these different levels of approval. A few provisions never formally received official approval on any level, but were ostensibly accepted as though integral to an approved "operation plan."

834. Another source of difficulty was the extreme security sensitivity attached to planning activity during the crucial first ten days of the crisis. Whatever its original justification, the denial of timely information regarding planning developments to all those having a functional need to know worked a serious hardship on staff personnel within the OJCS as well as on planners

TOP SECRET

~~TOP SECRET~~

and operators in the field. It was especially acute in relation to the approving of plans. [In the case of the invasion plan, use of the "Exclusive For" device in message addressing prevented adequately broad dissemination of explicit notification as to which particular basic plan had been decided upon, and served to prolong the confusion already associated with the term "approved." Precisely which invasion plan had been adopted was not clearly understood by all concerned until well after the crisis had reached and passed a climax and was apparently on its way to being resolved without recourse to military hostilities.]

836 A marked feature of Cuban contingency planning was that it was a dynamic on-going process. Despite the coming of the crisis having thrust the contents of the planning from the realm of hypothesis into the reality of the here and now, planning requirements rather than being narrowed and simplified thereby, were expanded and made more intricate. Precisely because the plans were never implemented, yet had to keep adjusting to the vicissitudes of events and needs, they never achieved final form but were constantly in transitional growth. At no point could they have been said to be complete; at least some aspect was always in flux, either being initially formulated or undergoing transformation. As a consequence, the contingency plans progressively grew in dimension and detail.

837 Some of the planning developments were internally generated within the military establishment. Among these were the changes that effected a consolidation of tactical command structure to centralize control over the planned contingency operations. By far most of the motivation for planning activity, however, came from outside, emanating from a political source at the very apex of the command and control pyramid. As in other crisis-related activity, the national decision-making authority injected

TOP SECRET

- 341 -

~~TOP SECRET~~

TOP SECRET

~~TOP SECRET~~ E

itself whenever it chose into the contingency planning machinery and laid down the governing terms of reference or stipulated specific provisions to be incorporated into the plans. Indirectly, even the rationale for modification of command relations can be traced ultimately to the same source. [Certainly the impetus for augmentation of force level commitment, [redacted] and for reducing reaction times was given at the highest civilian executive echelon.]

837. In this larger environment, the command and control processes operative in military contingency planning tended to be ad hoc rather than institutionalized. Although these processes did not follow consistently a formally established organizational or procedural scheme, nor comply with a systematic body of doctrine, there were certain general patterns apparent. The genesis of important planning developments during the crisis was characteristically at the national decision level, the White House usually being the prime mover, while the substantive planning was actually performed on the CINCLANT level, often at the Service component echelon. The JCS planning role thus was frequently that of passive intermediary between planning principals -- the political authority whose requirement initiated planning action and the tactical force commander concerned who did the operational planning. Typically in such an agent capacity the JCS merely conveyed the planning requirements received from the Executive Office or Secretary of Defense, often without any evident amplification or further guidance, directly to CINCLANT (who in turn might sometimes delegate them to a subordinate commander), then passed CINCLANT's responses back to the originator with little amendment. The chief JCS function in these instances was follow-through staffing, to coordinate and monitor all the planning action precipitated

TOP SECRET

- 342 -

~~TOP SECRET~~

TOP SECRET

~~TOP SECRET~~

by any particular requirement. It was the Cuban Planners of J-3 upon whom this monitoring responsibility devolved. In short, the military contingency planning function did not constitute a "system" in the proper sense of the term, but consisted of a series of discrete responses to explicit external requirements.

838. There was generally a positive correlation between elapsed time and scale of force commitment. Progressively during the life span of the crisis (and even beyond) the trend was upward, with the size of the planned force commitment ever expanding.

839. The tendency was to a large extent a normal rectification of the original underestimated force requirements resulting from appraisal of the enemy situation as it had existed earlier in 1961, which now had to take into account reassessments reflecting a greatly improved Cuban military capability. But to some extent the tendency to keep raising the level of force commitment was less directly related to conventional order-of-battle intelligence factors. Passage of time alone allowed the luxury of giving consideration to some of the more peripheral operational requirements attending or flowing from implementation of the plans, and it also invited the making of new provisions to accommodate some of the more remote possibilities that developments could conceivably take.

840. Perhaps most important, however, was the desire on both operational and policy levels to ensure adequate safety margins. The Bay of Pigs had cast a long shadow, and everyone was predisposed to have enough forces this time "just in case." Tactical commanders were inclined to add, on their own initiative, extra combat strength in excess of that authorized in plans when they deployed their forces, while top national decision makers went further and formally directed large-scale augmentation of the planned force commitment, even in the face of military advice to the contrary.

TOP SECRET

- 243 -

~~TOP SECRET~~

E

~~TOP SECRET~~

TOP SECRET

841. The cumulative effect of these various incentives was a steady qualitative and quantitative increase over time in the total magnitude of force available for planned Cuban contingency operations. By the time the crisis had run its course the increases in the planned commitment had exhausted the force resources on hand and affected a significant portion of the reserves.

842. Neither of the two contingency plans was a self-contained quantum that, if ordered executed, would inexorably be carried out in toto. Many provisions were never intended to be automatically implemented in due course, but were contingent upon being expressly so directed at the time by decision of higher authority. These conditional or reserved provisions in effect constituted yet another order of contingency planning over and above the contingency plans proper.

[REDACTED]

In the case of the air-strike plan, implementation was elaborately qualified so as to apply to individual portions, all codified according to scale and type of operation. Only that increment specified would be carried out and no more. The substance of other provisions, such as some of those pertaining to civil affairs matters, for example, was by design unspecified and deliberately left open-ended, simply because it could not be determined beforehand but would depend upon the course of unfolding events once operations actually began.

843. [A large share of the problems encountered in contingency planning for the Cuban crisis arose precisely as a result of efforts to respond to exacting command and control demands of national decision-making authority. Foremost and most persistent]

TOP SECRET

~~TOP SECRET~~

TOP SECRET

~~TOP SECRET~~

[ was the problem with reaction times in conjunction with discriminate magnitude of force application. All of the changes attending definition of selective options and minimization of their respective lead-times came into being because of Presidential insistence on as close as possible to instantaneous execution capability to carry out, on order, predetermined operational courses of action in specified kind and measure -- at his discretion as the nation's Commander-in-Chief. The main vehicles of command and control for realizing this decision flexibility were the contingency plans.]

844. [The degree to which these national command and control desiderata were satisfied during the Cuban crisis is unprecedented.

[As provided for in contingency plans, a major airborne and amphibious invasion would have been under way seven days after a national decision to implement CINCLANT OPLAN 316-62. For the FIRE HOSE option of CINCLANT OPLAN 312-62, at one point in the crisis the time lag between the President's "Execute" and TAC's "bombs on target" would have been something less than one hour; over a sustained period it would have been under three hours. About the same reaction time was provided for in the even more ambitious FULL HOUSE option of the plan.] Such fine-grained choices among military alternatives by the political decision-making authority had never before been approached.]

TOP SECRET

- 345 -

~~TOP SECRET~~



TOP SECRET

~~TOP SECRET~~

VIII. TERMINATION OF THE CRISIS

845. One characteristic of military activities during a crisis is that they often tend to develop a momentum of their own which compels them to continue after the political circumstances which spawned them have been resolved or ceased to exist. Cuba was generally a notable exception, despite the scale of military operations. Once the political crisis had started down toward resolution, U.S. military activity kept pace with it. Readiness was gradually reduced and forces dispersed piecemeal. To be sure, part of this process was compulsory, the result of the inexorable pressure of maintenance and training needs. At the same time the military stand-down, in step-by-step phasing with the progressive political easing of tensions, helped to achieve the political objective of portraying the U.S. as willing to settle the problem peacefully out ever ready to revert to military means if necessary,

TOP SECRET

- 34. -

~~TOP SECRET~~

TOP SECRET

A. POLITICAL RESOLUTION OF THE CRISIS

345. As with the U.S. military deployments, the political resolution of the Cuban crisis fell into two phases. The first ended with the Soviet concession on October 28, and was characterized by an essentially exclusive exchange between the U.S. and the Soviet Union. Once the Soviet agreement to withdraw the missiles had been achieved in principle, the next phase, extending from October 28 to November 20, involved the efforts and negotiations to ensure that the Soviet commitment was carried out. During this period participation in the negotiations broadened to include the Cubans, the United Nations, and even the International Red Cross.

347. The copy of the President's address of the 22nd that was transmitted to the Soviets was accompanied by a personal message to Premier Khrushchev. In it the President stated that he wished Khrushchev to know immediately and accurately the position of the U.S. in this matter, emphasizing that in various U.S.-Soviet discussions he had always feared that the Soviet leader would not understand the will and determination of the U.S. He recalled that at Vienna he had told the Premier that the U.S. would not tolerate any Soviet action which in a major way disturbed the existing balance of power. He further stressed that the U.S. action now being taken was the minimum necessary, but that the Soviets should not thereby make any misjudgment.<sup>1</sup>

<sup>1</sup>State message 961, October 22, 1962, CONFIDENTIAL.

TOP SECRET

TOP SECRET

~~TOP SECRET~~

848. The official Soviet reaction came on the 23rd in a formal note which denied that the arms in Cuba were offensive in character. It was a relatively mild and obviously hesitant reply. Khrushchev also sent a private letter to the President, rejecting both the U.S. claims and the "interference with sovereign rights," but the tone of the letter was similarly restrained.<sup>1</sup>

849. The President immediately acknowledged the Russian letter with a brief message, saying that he was concerned that both leaders show prudence and do nothing to allow events to make the situation more difficult than it already was.<sup>2</sup>

850. On the same day the U.S. quarantine went into effect, and the U.S. resolution defending the American actions was presented in the U.N. The OAS supported the U.S. action in a meeting of its own. Throughout the world there was a marked absence of positive Soviet or Bloc reaction. There were press attacks aplenty but no military moves. Bloc military alerts were called without fanfare and readiness increased, but these were defensive moves. Both CINCPAC and CINCEUR reported no indications that the Bloc was preparing to initiate hostilities in their theaters and, especially important, no incidents occurred in super-sensitive Berlin.

851. Late on the 23rd came the first really hopeful sign when some of the Soviet Bloc snips heading to Cuba were seen to have changed course. Additionally, the reply from Khrushchev to a letter from Lord Russell, the British philosopher and pacifist who had introduced himself into the crisis, was moderate and promised that the Soviets would do nothing rash.

<sup>1</sup>State Message 1042, October 23, 1962, SECRET.

<sup>2</sup>State Message 985, October 23, 1962, CONFIDENTIAL.

TOP SECRET

- 343 -

~~TOP SECRET~~

TOP SECRET

032. The U.S. for its part, was making every effort to keep the crisis concentrated in the Caribbean. U.S. forces in Europe remained at low alert posture. A formal but not hostile message was sent via the Secretary of State to Moscow, detailing the procedures "unidentified" submarines should follow when challenged by U.S. naval forces. U.S. attaches in Moscow were ordered to continue to register for travel within the USSR, both for collection of indications information and to avoid giving the Soviets cause for viewing the absence of travel requests as a further indicator of possible hostile U.S. action.<sup>1</sup>

B1A5

033. The Secretary General of the U.N. personally intervened on the 24th, urgently appealing to the U.S. and the Soviets to suspend, respectively, the quarantine and the shipment of arms for a period of two or three weeks. The Soviets accepted the proposal the next day, but the U.S. neither refused nor accepted, emphasizing that the only answer to the crisis lay in the removal of the weapons from Cuba. The U.N. initiative was obviously unwelcome in Washington, since it offered the Soviets a potential chance to gain time.

034. Another private letter from the President to Khrushchev the next day restated the thesis that the Soviets had ignored the first challenge, despite numerous pledges not to send offensive weapons to Cuba.<sup>2</sup>

<sup>1</sup>Msg, DNI to ALUSNA, Moscow 241319Z October 1962, SECRET.

<sup>2</sup>DAIN 280236, October 25, 1962, CONFIDENTIAL.

TOP SECRET

- 4 -

TOP SECRET

~~TOP SECRET~~

855. The Soviet reply in the U.N. to the U.S. resolution on the same day further reflected a Soviet desire to avoid the appearance of a direct confrontation between the U.S. and the Soviet Union. The approach seemed calculated to create a climate for the U.S. reversal of the quarantine, to diminish the threat to the U.S., and to reduce growing tension among the Bloc nations. Reports from U.S. and Allied diplomats and military attaches in Bloc countries confirmed this nervousness.

856. Late in the evening of the 27th Khrushchev replied to the President's message of the same day in a letter which sounded very reasonable and sincere in its apparent candor. However, he stated that Soviet merchant ships would ignore quarantine instructions and that the Soviet Union would protect its shipping.<sup>1</sup> Since Soviet shipping had already begun to turn back in large numbers, the threat was viewed as primarily verbal.

857. At the same time, in the Caribbean, major Soviet submarine activity became apparent. The extent of these operations was considered significant in that plans must have been made well in advance of the current crisis and the submarines themselves deployed not later than the first week in October.

858. The 25th closed with a number of hopeful signs to its credit, all evidencing a Soviet desire to play down the crisis and to avoid a high seas confrontation. On the other hand, aerial reconnaissance of Cuba indicated

---

<sup>1</sup>DAIN 280090, October 25, 1962, SECRET.

TOP SECRET

- 350 -

~~TOP SECRET~~

~~TOP SECRET~~ L

TOP SECRET

that construction was continuing at the missile sites and hurried efforts at camouflage were being undertaken.<sup>1</sup>

The White House announced this fact the next day in a statement notable for its ominous overtones, suggesting forceful action in the fairly near future. While the attention of the world was riveted on a possible confrontation at sea, the Soviet actions with regard to the missile sites were far more critical. No incident on the quarantine line could be as serious, or as clearly an indication of Soviet intentions, as their actions now in regard to the missile sites. These were the real potential casus belli.

859. By the morning of the 27th all 24 SAM sites appeared to be operational, along with three of the six surface-to-surface missile sites. Of the six MREM sites and three IREM sites under construction, seven had four erectors in place at each site. Five nuclear assembly storage areas had been identified. B1A4

860. However, on the 26th both the U.S. and Soviet Union responded to a new appeal from the U.N. Secretary General, the Soviets agreeing to keep their ships away from Cuba for the next few days and the President promising that he would "try to avoid any direct confrontation at sea." The day also brought a very long private letter from Khrushchev to the President. It was moderate and reasonable, but vague and troubled and clearly tinged with fear. The Premier

<sup>1</sup>JCS Cuba Supplemental SITREP #6, 252000Z October 1962,  
TOP SECRET.

JCS Cuba Supplemental SITREP #9, 271200Z October 1962  
TOP SECRET.

TOP SECRET

- 331 -

~~TOP SECRET~~

TOP SECRET

stressed that Soviet leaders were rational and reasonable people, and he called for a joint effort to solve the crisis peaceably. For the first time the Soviet leader gave in print a clear indication of a Soviet willingness to withdraw its weapons.<sup>1</sup>

301. On the 27th Khrushchev sent another long message to the President, this time made public in a Moscow broadcast, proposing that the Soviets dismantle their Cuban missile bases and withdraw their jet bombers, if the U.S. did likewise in Turkey. The letter seemed patently an attempt to rescue something from the wreckage of Soviet policy, and in his reply the same day, the President simply ignored the morning Soviet message. Instead he based his reply upon the Khrushchev letter of the 26th, reading much into it which was veiled or merely hinted at in the letter. The President stated that the Khrushchev letter contained "proposals" which seemed generally acceptable, i.e., that the Soviets would dismantle its bases and remove its offensive weapons under U.N. supervision, and would halt further shipment of such weapons, in exchange for which the U.S. would halt the quarantine and pledge not to invade Cuba.

302. A White House communique issued shortly after the President's message implicitly dealt with the Soviet suggestion of a Cuba-Turkey deal, rejecting such a deal as totally irrelevant.

303. That afternoon the only U.S. combat loss of the crisis occurred when a U-2 disappeared over Cuba, a victim of the Soviet SAM's. It was unknown for several days just how the plane was lost, but plans were immediately laid to ensure

---

State Message 1101, October 26, 1962, SECRET.

TOP SECRET

TOP SECRET

~~TOP SECRET~~

that reconnaissance flights were protected and that further losses would bring prompt retaliation.

25. The close of the first phase of the political resolution of the crisis came with the Khrushchev message, broadcast over the Moscow domestic news service, at 1400Z on the 28th, accepting the terms of the President's last message, namely, dismantling of the bases and return of the equipment to the Soviet Union, under U.N. supervision. The Russian note made no reference to the suggested Cuba-Turkey deal. In answer, the President issued a statement welcoming the Soviet decision, pointedly adding that developments were approaching a point where events could have become unmanageable.

26. Castro appeared on stage at this point with a list of five demands on the U.S., in return for which he would agree to the suspension of missile site construction. These demands caused some concern during the next two weeks as a possible stumbling block to the U.S.-Soviet negotiations, but never really became the subject of serious negotiation. The U.S. continued to deal only with the Soviets.

27. The U.N. Secretary General flew to Havana on the 30th to confer for two days with the Cubans, and during this period the U.S. lifted the quarantine and suspended aerial surveillance. However, on his return the following day, the Secretary General could only say he had been informed that the missile sites were being dismantled. It was obvious that the Cubans had rejected any U.N. supervision and were sticking to their five demands. Moscow entered

TOP SECRET

- 35 -

~~TOP SECRET~~



TOP SECRET

~~TOP SECRET~~

the impasse by sending its First Deputy Premier Mikoyan to Cuba, but Castro on November 1 openly rejected any international inspection, including that by the Swiss International Red Cross Committee as had been suggested by the Soviets as an alternative to the U.N.

867. As to the dismantling of the missiles themselves there was some concern generated by reports to the JCS that initial photo interpretation of pictures taken by reconnaissance flights on the 29th indicated that work was still in progress at the missile sites. However, further reconnaissance changed the view, and the President was able to announce on November 2 that the bases were being dismantled and the missiles crated.

868. On the 4th the issue of the IL-28's became acute, since photographic evidence revealed that there had been no reduction in the number of bombers and that these were still being uncrated and assembled. The U.S. warned that the crisis could again become critical if these planes were turned over to the Cubans. This point remained the key issue during the remainder of the crisis, although the U.S. still clung, at least publicly, to its demand for a verification system. However, with each passing week, the likelihood of achieving this goal seemed to grow more remote. Not only did the Soviets employ delaying tactics in discussing the problem, but the U.S. insistence in simply a "close-in-lock" at the missiles being carried out of Cuba by Soviet ships tended to degrade heavily the U.S. claim that an on-site inspection system was necessary.

TOP SECRET

- 354 -

~~TOP SECRET~~

TOP SECRET

~~TOP SECRET~~

869. The Swiss International Committee of the Red Cross, an alternative to the U.N. inspection which Castro had rejected, had obviously had second thoughts, too. Despite the Soviet's proposal to use the organization in this capacity, and the U.S. willingness to accept, the Swiss organization withdrew itself from the situation on November 13 by refusing to accept any role.

870. This left only aerial reconnaissance as the sole U.S. means of verification, but on the 15th Castro threatened to shoot down U.S. reconnaissance aircraft as he had the U-2 that had disappeared on October 27. Consequently, the U.S. again promised swift retaliation, and reconnaissance flights continued.

871. Obviously the Soviet representative was bringing pressure on Castro to consent to removal of the bombers which Castro had claimed were Cuban property, unlike the missiles which had remained Soviet. At the same time the Soviet Union was at least publicly backing Castro's five claims against the U.S. However, suddenly on November 19 Castro informed the U.N. Secretary General that Cuba would not object if the Soviet Union removed the IL-28's. The next day Khrushchev informed the President that all the bombers would be withdrawn within thirty days.

872. The U.S. objectives had been achieved, although without the type of inspection and verification the U.S. had at first demanded. Therefore, the President ordered the quarantine lifted on the 20th, and the major political phase of the Cuban crisis came to a close, although negotiations for inspection dragged on inconclusively and finally came to a gradual end in December.<sup>1</sup>

---

<sup>1</sup>For fuller treatment of the problem of verification, see the chapter on The Naval Quarantine.

TOP SECRET

- 355 -

~~TOP SECRET~~

B. MILITARY ADJUSTMENT TO THE POLITICAL SETTLEMENT

873. The Soviet concession of October 28 came at a time when pressures were mounting for some decisive and forceful military action, and this action may indeed have been only hours away when the Soviets announced their willingness to withdraw. From the earliest indications of Soviet caution and hesitation, as evidenced in the turnabout of Soviet ships on the 23rd, the U.S. high command had been faced with two conflicting tendencies. One was to go slowly so as to give the Soviets time to withdraw. This meant accepting the evidences of Soviet caution and hesitation as such. The other pressure came from evidence that the Soviets, despite their political indications of caution, were nevertheless continuing to prepare the missile sites with the obvious intention of making them operational as soon as possible.

874. Thus, the desire of the U.S. political authorities for a political resolution of the crisis had to be balanced against the unchanged and, indeed by the 28th, apparently increasing threat. The JCS at this moment were in favor of direct military action. [They had recommended to the Secretary of Defense very early on the 28th that because of the continuing build-up in Cuba, CINCLANT OPLAN 312 be executed no later than Monday morning, October 29, unless there were irrefutable evidence in the meantime that the offensive weapons were being dismantled or rendered inoperable. They also recommended that CINCLANT OPLAN 316 be executed seven days afterward.<sup>1</sup> Their attitude was that the only sure way to eliminate the threat was by direct attack, and that in the long run this was the best course of action.<sup>2</sup>]

<sup>1</sup>JCSM-844-62, 28 October 1962, TOP SECRET.

<sup>2</sup>JCSM-831-62, 28 October 1962, TOP SECRET.

TOP SECRET

~~TOP SECRET~~

875. [The Chairman, however, dissented and in transmitting the recommendation for the Monday dawn strike stated to the Secretary that he had not participated in the JCS discussion leading to the recommendation. His duties as the military member of the Executive Committee over at the White House had kept him there. He had, however, read these same recommendations to the Executive Committee of the NSC the day before, October 27, including his disagreement. His position was that the U.S. should await further evidence of Soviet/Cuban reaction before taking the irrevocable step, while still maintaining continuous readiness to execute the plans.]<sup>1</sup>

876. The first JCS reaction to news of the Soviet concession Sunday the 28th was one of caution. Their opinion was that the Soviet proposal might well be an insincere effort to gain time, and therefore there should be no relaxation of alert procedures.<sup>2</sup> The JCS SITREP of that day analyzed the Khrushchev message and delineated its pitfalls, pointing out how the apparent concession could be utilized by the Soviets as a means to confuse the situation and weaken the U.S. position.<sup>3</sup>

877. The suspicion remained alive several more days until positive evidence of the dismantling of the bases was received. In fact, on the 30th CINCLANT forwarded to the JCS a message to him from CINCPACFLT, stating that initial examination of aerial photos taken on the 29th showed no evidence that the Soviets had as yet closed work on the sites, and that they seemed to be moving ahead as rapidly as possible in an all-out effort to get the sites operational. The dispersion and camouflage efforts being

<sup>1</sup> CM-61-62, 28 October 1962, TOP SECRET.

<sup>2</sup> JCS Msg 7065 to CINCLANT, CINCPACFLT, CINCSAC, 281556Z, October 1962, TOP SECRET.

<sup>3</sup> JCS Cuba supplementary SITREP 12, 232100Z October 1962, TOP SECRET.

TOP SECRET

~~TOP SECRET~~

TOP SECRET

undertaken, warned CINCPACFLT, meant that there might be only a few more days left in which the sites could be attacked with full assurance of success. He recommended ultimately a selective attack and reattack, but immediately urged a massive reconnaissance effort.

878. This large-scale, low-level reconnaissance effort was begun and evidence of the site dismantling was shortly found.

879. The Soviet concession, however, on the whole brought about an immediate lowering of tension. The sense of urgency seemed to leave the crisis, and while, as will be seen, U.S. forces remained alert for another month, the pressures of the latter period never equaled those of the first ten days.

C. DISMANTLING THE MILITARY BUILD-UP

880. The second phase of the crisis, just as the first, involved two contradictory trends. On the one hand was the feeling that the new period of political maneuver could provide a valuable opportunity to push ahead in the refining of plans and the increasing of contingency force readiness in case political negotiations failed to achieve the U.S. objective. On the other was the development very soon of the requirement to lower the readiness posture of some forces in response to the inevitable demands of maintenance, training and personnel morale.

881. The JCS took cognizance of the by now general problem of necessary stand down on November 6 when it notified CINCPACFLT, CINCSAC, CINCONAD, and CINCSTRIKE of a meeting to be held in Washington the next day. [The three subjects]

---

<sup>1</sup>Msg, CINCPACFLT to JCS, 301344Z, October 1962, TOP SECRET.

TOP SECRET

~~TOP SECRET~~

[To be discussed were the need for augmentation of the OPLAN 316 assault forces; the length of time their forces could maintain their present alert posture without significant degradation of combat capability (the date of November 15 was given as an approximate time for some degree of stand-down if there were no definite indications that OPLANS 312 and 316 would be executed); the propriety of rescheduling a large training exercise with the participation of the forces which had been assembled, while the period of high level of concentration still continued.]

882. Much earlier, however, the pressure for some sort of stand-down had begun. CINCONAD on the 29th had requested permission to return his fighters from their dispersal bases to home stations, except for the 32nd Region, emphasizing that the overall readiness to execute the general war mission would be enhanced by the opportunity to recycle weapons and check out and maintain aircraft.<sup>2</sup> The JCS concurred only in a partial reduction of CINCONAD's force dispersal at that time.<sup>3</sup> The sharp sense of relaxation which occurred is well illustrated by CINCONAD's case. Until the moment of the Soviet concession he had been making repeated requests for major augmentation of the air defenses of the southeast U.S., only to swing abruptly around and be the first to request some degree of stand-down. To be sure, CINCONAD's problem was primarily a general war one, and his role in the event of Cuban operations was not expected to be a major one. Therefore, with a first reduction of tension in the contingency area, CINCONAD doubtless seized

<sup>1</sup>Msg, JCS 724, to CINCLANT, 061710Z, November 1962, TOP SECRET;  
Msg, JCS 7248 to CINCSAC, CINCONAD, CINCSTRIKE, 061711Z,  
November 1962, TOP SECRET.

<sup>2</sup>Msg, CINCONAD to JCS, 291920Z, October 1962, TOP SECRET.

<sup>3</sup>Msg, JCS 7091 to CINCONAD, 292206Z, October 1962, TOP SECRET.

TOP SECRET

~~TOP SECRET~~

~~TOP SECRET~~

TOP SECRET

the opportunity to improve his major mission readiness. It should be recalled that CINCONAD's general war preparations had been disrupted somewhat by the necessity to augment the air defenses of the southeast U.S.

883.



884. The first relaxation in readiness posture came on Nov. 14 when the JCS cancelled MINIMIZE for all areas except LANCOM and CARIBCOM.<sup>3</sup>

885. The JCS met with the President on November 16 and reported on the readiness status of forces involved in the Cuban contingency plans. The memorandum they gave the President is a succinct summation of the readiness peak reached, although, in fact, the peak had already been passed two weeks earlier, as the preceding paragraphs have shown. By November 16 stand-downs had already occurred in a number of spots. The memo therefore portrayed a posture that really no longer exactly existed.

<sup>1</sup>Msg, CINCLANT to JCS, 302232Z, October 1962, TOP SECRET.

<sup>2</sup>Msg, CINCLANT to JCS, 130138Z, November 1962, TOP SECRET.

<sup>3</sup>Msg, JCS 7391 to all CINCs, 142318Z, November 1962, CONFIDENTIAL.

TOP SECRET

~~TOP SECRET~~

- (1) 312 - 2 days  
(2) 316 - 10 to 12 days (5th MEB and organic shipping excepted). ]

890. The JCS recommended staying in the present posture for the immediate future. All commanders were therefore ordered to maintain the readiness posture quoted in the memo until otherwise advised.<sup>1</sup>

890. [CINCLANT was authorized to conduct Exercises SUNSHADE, five exercises rehearsing the airborne phase of OPLAN 316, and involving the airborne divisions. However, the JCS warned him that each exercise would have to be evaluated to ensure that no real degradation of readiness to conduct 316 resulted.]

891. Within three days the situation changed. The quarantine was lifted, following the Soviet promise to remove the IL-28's, and CINCLANT was ordered to return all LANTFLT ships to home ports and normal operating areas at his discretion. He was instructed to keep one CVA with air group<sup>3</sup> ready in the Mayport-Caribbean area.

892. [The JCS sought the opinion of CINCONAD, CINCSAC, and CINCLANT the next day on recommended readiness levels to maintain a reaction time of 72 hours for OPLAN 312 and two weeks for 316. The various options of 312 and BLUE MOON reconnaissance requirements were also given longer suggested reaction times.]

<sup>1</sup>Msg, JCS 7441 to CINCONAD, CINCLANT, CINCSAC, 172324Z, November 1962, TOP SECRET

<sup>2</sup>Msg, JCS 7421 to CINCLANT, CSAF, 161937Z, November 1962, SECRET.

<sup>3</sup>Msg, JCS 7476 to CINCLANT, 202345Z, November 1962, TOP SECRET.

<sup>4</sup>Msg, JCS 7493 to CINCLANT, CINCSAC, CINCONAD, 211803Z, November 1962, TOP SECRET.

TOP SECRET

~~TOP SECRET~~



~~TOP SECRET~~

TOP SECRET

893

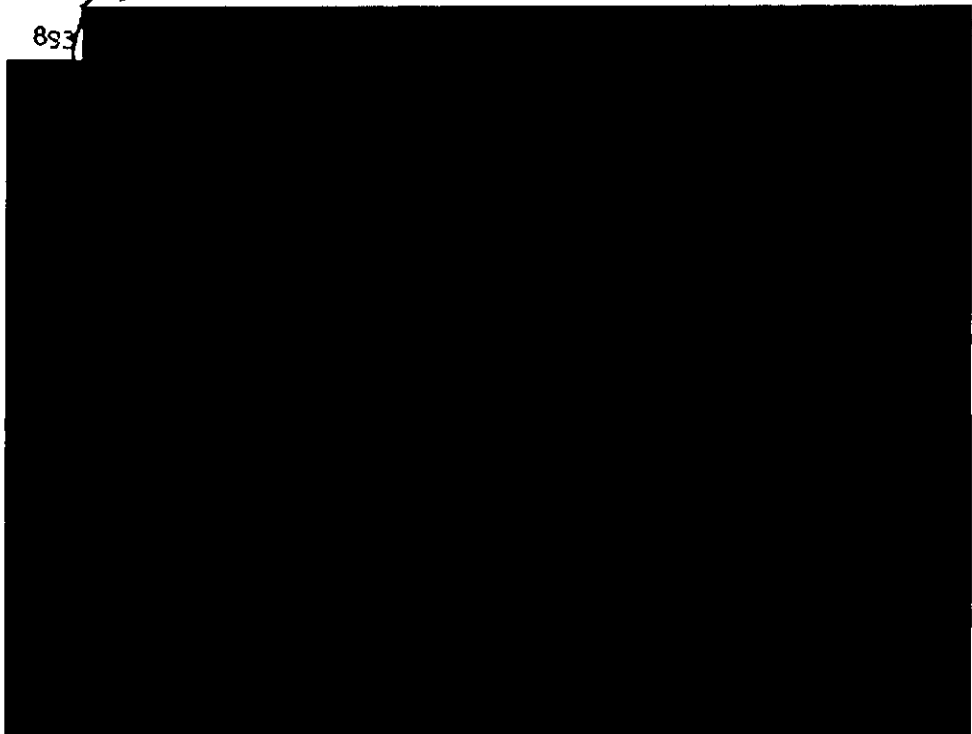

844. The final wind-up of the crisis machinery was recommended to the Secretary of Defense in a memorandum of November 28. It pointed out that the new phase of the situation was marked by [the termination of the 1/8 airborne alert (November 20), the return of the B-47's to their home bases (November 24), except for those in Florida,] the authorization to all commands to return to DEFCON 5, the release of the Air Force Reserve Troop Carrier Units, the return to normal operations of all naval forces and air squadrons associated with the quarantine. [Recognizing the need for continued reconnaissance, as well as maintenance and the problem of personnel hardship, the JCS recommended new reaction times with further reduction to a normal.]

<sup>1</sup>Msg, JCS to all CINCs, 272124Z, November 1962, TOP SECRET.

<sup>2</sup>JCS Cuba SITREP 37-62, 280500Z, November 1962, TOP SECRET.

TOP SECRET

~~TOP SECRET~~

~~TOP SECRET~~

TOP SECRET

pre-Cuba posture prior to Christmas, contingent upon the actual Soviet withdrawal of the IL-28's. Times were again spelled out for the various reconnaissance missions and the options of 312. OPLAN 312 itself was set at a 72-hour reaction time and 316 at 18 days. All air defense units would resume normal posture except units needed for permanent augmentation of the southeast U.S.

895. Authority was requested to return all West Coast Marine units and all but a few small Army units to home stations immediately. The objective was to be the return of all units to home posts by Christmas, including the return of dependents to Guantaramo.

896. The memorandum was approved by the Secretary of Defense, and all commanders were requested to implement it with respect to the units assigned to their operational control 1

897. With this order, to all intents and purposes, the military phase of the Cuban crisis came to an end. Both offensive and defensive machinery was in the process of dismantlement. Reconnaissance of Cuba continued and the inspection of outgoing Soviet ships carrying the IL-28's had still to be conducted, but the largest peacetime marshaling and deployment of U.S. forces rapidly secured history.

1. Issg, JCS 7500 to CINCLANT, 282249Z, November 1962,  
TOP SECRET.

TOP SECRET

- 354 -

~~TOP SECRET~~