

THIS FILE IS MADE AVAILABLE THROUGH THE DECLASSIFICATION EFFORTS AND RESEARCH OF:

THE BLACK VAULT

THE BLACK VAULT IS THE LARGEST ONLINE FREEDOM OF INFORMATION ACT / GOVERNMENT RECORD CLEARING HOUSE IN THE WORLD. THE RESEARCH EFFORTS HERE ARE RESPONSIBLE FOR THE DECLASSIFICATION OF THOUSANDS OF DOCUMENTS THROUGHOUT THE U.S. GOVERNMENT, AND ALL CAN BE DOWNLOADED BY VISITING:

[HTTP://WWW.BLACKVAULT.COM](http://www.blackvault.com)

YOU ARE ENCOURAGED TO FORWARD THIS DOCUMENT TO YOUR FRIENDS, BUT PLEASE KEEP THIS IDENTIFYING IMAGE AT THE TOP OF THE .PDF SO OTHERS CAN DOWNLOAD MORE!

fn 94-F-1926



THE ADVANCED RESEARCH PROJECTS AGENCY

THE BALANCED TECHNOLOGY INITIATIVE:

ANNUAL REPORT TO CONGRESS

FOR THE

COMMITTEES ON ARMED SERVICES

COMMITTEES ON APPROPRIATIONS

UNITED STATES CONGRESS

April 15, 1993

Approved for public release;
distribution is unlimited

727

TABLE OF CONTENTS

Section	Page
Table of Contents	i
1 Program Overview	1
Introduction.....	1
Summary of Recent Accomplishments	1
Short Range Antitank Weapon	1
Autonomous Guidance for Conventional Weapons (AGCW).....	2
Directed Infrared Countermeasures Systems.....	2
Uncooled Focal Plane Array.....	2
Navy Electro Thermal Gun.....	3
Low Cost Anti Armor Submunition (LOCAAS)	3
Quiet Knight	4
Ultra Wideband Radar.....	4
Management Actions	4
BTI Project Transition.....	5
2 Summary of BTI Projects	7
3 BTI Project Status Reports	22

**SECTION 1
PROGRAM OVERVIEW**

INTRODUCTION

This report responds to provisions of the Fiscal Year 1990 Defense Authorization Act and Fiscal Year 1993 Defense Authorization Conference report. The former requires that the Secretary of Defense submit to the congressional defense committees an annual report on the Balanced Technology Initiative (BTI). The latter instructs "...the Department of Defense should report to the Committees on Armed Services of the Senate and the House of Representatives not later than April 15, 1993, regarding the Department's future plans for the balanced technology initiative."

This is the final BTI annual report. The Department is discontinuing the centralized management of BTI as a program. The President's Defense Budget Request for Fiscal Year 1994 includes no funding for BTI. Responsibility for individual BTI projects is now assigned to a service or to the Advanced Research Projects Agency (ARPA). Funding for some of the continuing projects is included in service or ARPA budget requests. This report covers only BTI funded activity (FY 1993 and prior) and does not attempt to explain or justify the services' or ARPA's FY 1994 programs.

This report contains the following:

- A summary of recent BTI accomplishments
- Management actions
- Project one-page summaries
- Project status reports.

SUMMARY OF RECENT ACCOMPLISHMENTS

Short Range Antitank Weapon

PREDATOR, formerly called SRAW, is a 20-lb guided missile that will provide the individual Marine infantrymen the ability to destroy any tank on the battlefield. This weapon is nearing the end of its advanced development test series. Over thirty missiles have been flown against tank targets at ranges up to 700 meters and at target speeds up to 40 km per hour. Over 90 percent of these missiles have accurately guided to the target. The warhead, essentially the same as the TOW 2B warhead, has been tested separately. Difficulties with a safe/arm device caused several warhead no-fires, but now this device has been replaced with a proven safe/arm device. Using this proven device, an all-up round including the warhead has been tested successfully. The tank target, protected by reactive armor to simulate a future advanced threat, was destroyed. Work is now underway on a multi-purpose variant of PREDATOR to provide a means to destroy

buildings and bunkers. The PREDATOR is scheduled to enter engineering and manufacturing development (EMD) this year.

Autonomous Guidance for Conventional Weapons (AGCW).

The AGCW is a precision guidance system that uses an imaging infrared sensor. It works by correlating the sensed image of the target area with characteristics of the target that have been stored in the guidance system computer. It is particularly well suited to fixed targets (airfield installations, bridges, command bunkers, etc.) for which good intelligence information can be obtained before planning the strike mission. Three tests were performed in which the AGCW seeker guided a 2,000-lb bomb by means of the GBU-24 control system. All three tests were successful, the bombs impacting the targets within a few meters of the programmed aimpoint. AGCW could be applied to the Joint Direct Attack Munition (JDAM) and the Joint Standoff Weapon (JSOW).¹

Directed Infrared Countermeasures Systems

BTI developed and tested active countermeasures to defeat the infrared guided missiles that threaten our helicopters and transport aircraft. Two directed infrared countermeasures (DIRCM) systems were tested. Both used high intensity flash lamps as the countermeasure source. The systems detect the heat of an incoming missile and point the countermeasure source at the missile, confusing the missile seeker, and causing the missile to miss its target. The DIRCM systems are superior to existing systems because of their directional characteristic, which allows the countermeasure energy to be concentrated where it can be most effective. Both DIRCM concepts completed testing successfully. The helicopter DIRCM technology has been incorporated into the Army Advanced Threat IRCM (ATIRCM) program, now in development. The Special Operations Command (SOCOM) deferred plans to acquire the transport DIRCM while evaluating a modular approach that would be done jointly with the Army. BTI also has a DIRCM project that uses a laser for the countermeasure source. This project, far more challenging than the others, will meet the more stringent requirements of fighter aircraft and the largest transports.

Uncooled Focal Plane Array

This project is now referred to as the BTI Low Cost Uncooled Sensor Project (LOCUSP). LOCUSP is developing and demonstrating true thermal sensors that operate at normal room temperatures.² Conventional thermal sensors must have their detectors cooled to

¹ The AGCW seeker would be used in phase 3 of the JDAM and/or JSOW programs to develop a precision capability. Both programs are joint between the Air Force and the Navy.

² There are two basic types of night vision sensors. The type used in night vision goggles are image intensifiers, i.e. they amplify very low levels of light reflected from the scene. The other type, used in FLIRs (forward looking infrared),IRSTs (infrared search and track), and some weapon sights (e.g. the Javelin), are thermal viewers, i.e. they sense the thermal radiation that is emitted by all bodies even if

cryogenic temperatures. The objective of LOCUSP is to achieve a sensitivity in a large array to detect a 0.1°C difference in temperature of the target scene. Two contractors developed detector and fabrication technologies, and both have achieved the required sensitivity in arrays of about 120,000 detectors. One of the contractors has delivered about two dozen systems that utilize these uncooled focal plane arrays. These deliveries are weapon sights and surveillance systems.

The Army, the Air Force and the Immigration and Naturalization Service are all currently engaged in evaluating these systems in a variety of military and civil applications. One possible near term application is the Drivers' Vision Enhancer, an Army system to permit vehicles to be driven without lights at night and through smoke, fog and dust. ARPA plans to continue the LOCUSP project with the objectives of lowering the cost through advanced manufacturing methods and simultaneously achieving a sensitivity of 0.05°C . If successful, this will greatly expand the applications for these arrays. These uncooled focal plane arrays are a good example of dual use technology. They ultimately can be applied to a wide variety of products in the civilian as well as in the military world.

Navy Electro Thermal Gun

The Navy Electro Thermal Gun project is being developed as a candidate system to provide ship defense against the hypersonic, maneuvering, sea skimming missiles that will soon pose a serious threat to our ships. The project has achieved milestones in several areas during the past year. The project is developing a command guided projectile, a fire control system, an electro thermal chemical (ETC) cartridge as propulsion for the projectile, and an automatic gun to fire the ETC rounds. The project has obtained consistent ETC cartridge performance, fired multiple ETC rounds from the gun, and demonstrated a tracking system to be used for fire control. The guided projectile, a critical part of the project, is in development and is scheduled for live tests at the end of this calendar year.

Low Cost Anti Armor Submunition (LOCAAS)

LOCAAS is an attempt to prove that we can develop smart submunitions that will be both very effective and affordable. Two concepts are being developed. One uses a laser radar (ladar) to search for and track targets. The other uses a millimeter wave radar with innovative signal processing. Both concepts are wide departures from submunitions currently in development.

there is no ambient light. High performance thermal viewers have detectors that must operate at very low temperatures, typically about minus 300 F. To achieve such temperatures these systems use special cryogenic refrigerators or they use high pressure stored gas that can be expanded to provide temporary cooling. Elaborate dewars and radiation shields are used to maintain the temperature. This need to operate at cryogenic temperatures has several disadvantages. It adds expense; it requires extra power, space and weight; and some of the systems also make noise.

During the past year the LOCAAS submunition seekers have undergone extensive testing both from a tower and in captive carry aboard a helicopter. They were tested against a variety of intended targets in tactical deployments and in the vicinity of natural and man made clutter. Preliminary test results are very encouraging, and test analysis is continuing both to evaluate the seekers and to improve their algorithms. During 1993 the LOCAAS submunitions will be tested in free flight.

There are potential applications for both the LOCAAS seekers and the complete submunitions. One of the seekers is a strong candidate for incorporation into the ongoing Brilliant Anti Tank (BAT) submunition. Both seekers are candidates for the Air Force/Navy JDAM and JSOW weapons developments.³

Quiet Knight

Quiet Knight Phase I has successfully demonstrated an integrated avionics suite to provide low level, undetected ingress and egress through enemy territory. Phase II is now in progress to expand the capabilities to include off-board and on-board threat warning and real-time route replanning. USSOCOM has established a program office in their research, development, and acquisition center (SORDAC) to transition Quiet Knight technologies into both fixed and rotary wing special operations aircraft.

Ultra Wideband Radar

The Ultra Wideband (UWB) Radar project, a Congressional initiative, reached a milestone during 1992 when an UWB synthetic array radar (SAR) in an aircraft successfully imaged a forested region and proved that this radar, operating at frequencies below one gigahertz, could penetrate foliage and reveal objects that are invisible to sight, infrared sensors, and conventional radars. This dual use technology is being further developed by ARPA and will become a key element in the S&T Thrust 2, Precision Strike. The UWB radar technology also has potential civilian uses.

MANAGEMENT ACTIONS

When the decision was taken to disestablish the Balanced Technology Initiative, the BTI program consisted of sixteen projects. Of the sixteen ongoing projects, three have since been completed as planned.⁴ The remaining thirteen projects are being transitioned to the services or ARPA for management. The following table lists the current projects with the receiving organization, the using services, the project management organization, and the funding provided from the BTI program element (0603737D) in FY 1993.

³ The LOCAAS seekers are also candidates for the phase 3 of JDAM and JSOW when precision capability is required.

⁴ HAWKEYE; Combat Vehicle Command & Control (CVC2); Millimeter Wave Seeker Demonstration

PROGRAM OVERVIEW

BTI Project Transition

Projects	Receiving Organization	Using Service	Project Management	FY 1993 BTI Funds (\$ million)⁵
Navy ET Gun / Target Acquisition for Ship Defense (TASD) Radar	Navy	Navy	Naval Sea Systems Command	13.7
Enhanced Kinetic Energy Munition (X-ROD)	ARPA	Army	Army Research, Development & Engineering Center	20.3
Short Range Antiarmor Weapon (PREDATOR)	Marine Corps	Marine Corps	Marine Corps Systems Command	9.9
Anti Helicopter Mine	ARPA	Army	Army Research, Development & Engineering Center	5.2
Imagery Exploitation System (IES/BTI)	ARPA	Army	Army Topographic Engineering Center	7.8
Advanced Technology Tactical Radio (SPEAKEASY)	Air Force	Air Force/ Army/Navy	Air Force Electronics Systems Center	9.0
Directed Infrared Countermeasures (DIRCM)	Navy	Navy/Army/ SOCOM	Naval Research Laboratory	4.8
Multi-Mission Seeker	Army	Army/ Navy/ Marine Corps	Army Missile Command	12.0
Low-cost Antiarmor Submunition (LOCAAS)	Army	Army/ Air Force	Army Missile Command	15.9
Autonomous Intelligent Submunition (DAMOCLES)	ARPA	Army	Army Research, Development & Engineering Center	13.7
Low-cost Uncooled Sensor Project (LOCUSP)	ARPA	Army/ Air Force	Army Night Vision Electro-optics Division	1.9
Quiet Knight	SOCOM	Air Force/ SOCOM	Air Force Aeronautical Systems Center	15.1
Ultra Wideband Radar	ARPA	Air Force	Air Force Aeronautical Systems Center	7.2

⁵ Funds shown reflect SBIR taxes and other undistributed reductions as applicable.

Several management actions have been taken to maximize the benefits derived from BTI projects while minimizing the need for future funding. The Directional Infrared Countermeasures program was replanned so that substantial segments of the project -- the field testing of the threat warning system, the full power operation of the countermeasures laser, and the operation of the frequency converter -- can be completed with FY 1993 funds. In this way there will be a useful product, the threat warning system, and proven technology even if there is no funding to integrate and test the complete system in FY 1994. The Low Cost Antiarmor Submunition project followed a similar strategy, replanning the project so that the submunitions will be field tested in free flight using only FY 1993 funds.

Quiet Knight Phase II added new features in accordance with Congressional wishes to see the special capabilities provided by this project expanded. The Ultra Wideband Radar project, after completing the research funded by an FY 1991 Congressional initiative, began a continuation of this valuable new technology to provide a means to locate hidden targets.

There is no budget request for the overall BTI program in FY 1994. Any funds requested for the individual projects in FY 1994 are included in the budget requests of the services or ARPA. The FY 1992 and FY 1993 Defense appropriations conference reports asked that memoranda of agreement (MOAs) be concluded between the BTI office and the services or agencies for any project that would require funds in FY 1993 and later. MOAs were concluded for all such projects but one.⁶

⁶ The Army has not been able to certify that they will proceed with the X-ROD project even if it is fully successful. X-ROD provides a capability for our tanks to defeat enemy tanks at long range, up to 4 km. It does this with a guided kinetic energy projectile. The Army currently has in EMD (engineering and manufacturing development) a round called STAFF. If successful, STAFF can provide a capability similar to X-ROD though differing in lethality and susceptibility to countermeasures.

SECTION 2

SUMMARY OF BTI PROJECTS

This section presents tabular summaries of the current BTI projects. Additional information on selected projects is provided in the BTI Project Status Reports in Section 3.

Project	Page
BTI Projects Funding Summary (\$ millions).....	8
Navy Electrothermal Gun (ET Gun).....	9
Enhanced Kinetic Energy Munition (X-ROD).....	10
PREDATOR (formerly SRAW/Short Range Antitank/Assault Weapon).....	11
Anti Helicopter Mine (AHM).....	12
Imagery Exploitation System (IES/BTI)	13
Advanced Technology Tactical Radio (SPEAKEASY)	14
Directed Infrared Countermeasure System Prototype (DIRCM)	15
Multi-Mission Seeker (MMS) Demonstration	16
Low Cost Anti Armor Submunition (LOCAAS) Demonstration.....	17
Damocles Autonomous Intelligent Submunition	18
Low Cost Uncooled Sensor Project (LOCUSP)	19
Quiet Knight	20
Ultra Wideband / High Power Microwave (UWB/HPM) Technology	21

BTI ANNUAL REPORT

BTI Funding Summary (\$ millions)

Project	FY 1992 & Prior	FY 1993	ARPA FY 1994
Navy ET Gun	28.1	13.7	
Enhanced Kinetic Energy Munition (X-ROD)	71.5	20.3	
Short Range Anti-Tank Weapon (SRAW)	41.4	9.9	
Anti Helicopter Mines (AHM)	37.5	5.2	2.0
Imagery Exploitation System (IES/BTI)	16.4	7.8	5.4
Advanced Technology Tactical Radio (Speakeasy)	11.1	9.0	4.5
Directed IR Countermeasure System (DIRCM)	34.9	4.8	
Multi-Mission Seeker (MMS) Demonstration	7.2	12.0	
Low Cost Antiarmor Submunition (LOCAAS)	22.8	15.9	
Damocles (Phase II)	32.7	13.7	8.6
Low Cost Uncooled Sensor Prototype	22.8	1.9	4.3
Quiet Knight	40.1	15.1	
Ultrawide Band/High Power Microwave	19.2	7.2	8.5
Contingency Force Technologies ¹		3.7	
Program Planning and Technical Assessment	7.1	1.5	
Total	392.8	141.7	33.3

¹ Not previously part of BTI program.

NAVY ET GUN

- Project:** Navy Electrothermal Gun (ET Gun)
- Project Objective:** The objective of the Navy ET Gun project is to accelerate development of surface ship defense against supersonic, highly maneuverable, sea skimming, cruise missiles.
- Operational Utility:** ET guns will increase the range of battlefield and shipboard gun systems. Performance enhancements include increased muzzle velocity, improved safety, reduced vulnerability, and the extended utility of existing conventional gun systems. Because it includes the development of guided projectiles, the ET gun project will increase the ratio of kills per shot. The technology resulting from the ET gun projects will be applicable to future Army and Navy gun designs.
- Status:** The Navy ET gun project includes the TASD radar project with the expectation that the TASD radar will support ET gun testing. The funded program includes seven major tasks that will be completed in early FY 1994:
- 60mm gun mount and autoloader development
 - Electrothermal cartridge development
 - Command guided projectile development
 - Radar/electro-optical system integration
 - Gun system effectiveness studies
 - Ship integration studies
 - Total system integration and demonstration
- Accomplishments:**
- The gun has been fired with conventional and ET ammunition, and integration with the Navy Close-In Weapon System (CIWS) gun mount is nearing completion
 - ET cartridge design has been optimized
 - EO tracker tests passed accuracy requirements
 - Guided projectile completed basic aerodynamic testing, and guidance component testing is underway
- BTI Funding (\$ millions):**
- | | |
|--------------------|-------|
| FY 1992 and prior: | 28.1M |
| FY 1993: | 13.7M |
- Project transition plan:** Project direction has transitioned from BTI to the Navy. Further testing of the system concept is being considered by the NAVSEA Advanced Gun Weapons Technology Program, PE 0603795N, and an FY 1994 Advanced Technology Demonstration, PE 0603792N, in accordance with a Navy/BTI MOA .
- Executive Agent:** The program is managed by NAVSEA, Arlington, VA., with technical direction by the Naval Surface Warfare Center, Dahlgren Division.
- Contractors:** FMC, Minneapolis, MN; General Electric, Philadelphia, PA; General Dynamics Corporation, Warren, MI

X-ROD

Project: Enhanced Kinetic Energy Munition (X-ROD)

Objective: The objective of the BTI X-ROD project is to accelerate the development and demonstration of guided, boosted 120mm kinetic energy projectiles that can defeat enemy armor at long range.

Operational Utility: X-ROD will provide current tanks with:

- Extended lethal range
- Improved probability of hit with guided projectiles
- Improved probability of kill from inflight boost and long rod penetrator

Status: The project is in Phase IIIA of a three-phase effort leading to engineering and manufacturing development. In the first phase, 3 concepts were developed. Two of these were selected to continue into Phases II and IIIA. The command guided approach was subsequently eliminated. The remaining concept uses an autonomous millimeter wave seeker.

Accomplishments: Critical components have been developed and tested. Simulations have been updated. Efforts to characterize the brassboard seeker, radome, maneuver mechanism, and high-g electronics packaging development have been completed. Rocket motor case and propellant development have been initiated.

BTI Funding (\$ millions):

FY 1992 and prior:	71.5M
FY 1993:	20.3M

Transition plan: ARPA is the executive agent for the BTI X-ROD project. Project direction transitioned from BTI to ARPA in January 1993. Because there is no funding for X-ROD beyond FY 1993 in the Army or ARPA budgets, the project is being restructured to complete the guide-to-hit demonstration and postpone indefinitely the propulsion technology demonstration.

Executive Agent: Overall program management for X-ROD is provided by ARPA Land Systems Office. Technical management is provided by ARDEC, Picatinny Arsenal, NJ.

Contractors: Hercules Defense Electronics Systems, Inc., Clearwater, FL (Prime)

PREDATOR

- Project:** PREDATOR (formerly SRAW/Short Range Antitank/Assault Weapon)
- Project Objective:** The objective of this BTI project is to develop, fabricate, and demonstrate a lightweight, proliferable, short range antitank weapon capable of defeating both current and future enemy tanks. It will be used by Marine infantry and possibly by the Army and Special Operations Command. The basic PREDATOR is a top-attack weapon with modular warhead and airframe sections. The project also has started development of a direct attack, bunker-buster warhead module (multiple purpose variant, MPV). The Marine Corps is considering still other, more specialized warhead variants, such as fuel-air explosives, (FAE) to satisfy the service's Mission Needs Statements.
- Operational Utility:** PREDATOR will meet the Marine Corps and others needs for a light weight antitank and assault weapon.
- Modular design for multiple variants
 - Lethal to bunkers and structures
 - Lethal to all known tanks
 - Fire from within enclosures
 - No maintenance required, disposable
 - High probability of hit
 - Fire and forget
 - 20-pound system weight
 - 17-500 meters range
 - No training required
- Status:** The primary, top attack version of PREDATOR is about to complete the flight test phase of demonstration/validation with a Milestone II scheduled for September 1993. USMC-funded EMD will commence in FY 1993, and the variants will be demonstrated in parallel with EMD.
- Accomplishments:**
- Over 40 flight tests substantially exceeding requirements.
 - Both top attack and direct attack profiles demonstrated.
 - Risk reduction activities to EMD are ongoing.
 - Two full-up missiles with warheads tested successfully against a tank target.
- BTI Funding (\$ millions):**
- | | |
|--------------------|-------|
| FY 1992 and prior: | 41.4M |
| FY 1993: | 9.9M |
- Project transition plan:** The BTI project will produce and test pre-EMD prototype hardware. The project is scheduled to transition to the Marine Corps to begin EMD in FY 1993. A continuation of the R&D program by the Marine Corps will demonstrate a direct attack warhead variant for use against bunkers and other high priority non-tank targets. Other NATO countries have expressed interest.
- Executive Agent:** PREDATOR is managed for BTI by the Marine Corps Systems Command (MARCORSYSCOM), Quantico, VA
- Contractors:** Loral Aeronutronics, Newport Beach, CA (Prime); Aerojet, Azusa, CA; Hercules, Rocket Center, WV; Systron Donner, Concord, CA; Talley Defense, Mesa, AZ

AHM

- Project:** Anti Helicopter Mine (AHM)
- Project Objective:** The purpose of the AHM project is to develop a mine system to deny nap-of-the-earth flight and pop-up tactics to attack helicopters. The program consists of minefield communications and control (completed) and anti helicopter mines (in process).
- Operational Utility:** Employment of the AHM will:
- Eliminate the attack helicopter's primary survival technique
 - Deny the enemy the use of airfields and forward area supply points
 - Deny the use of landing zones in friendly territory
 - Deny use of terrain and woods for obscuring approach
 - Present obstacles to approach
 - Provide flank security to friendly forces
 - Provide security for outposts and isolated forces
 - Attrit and disrupt enemy forces
- Status:** AHM is in a 26-month second phase effort to demonstrate form, fit, and function of two competing design concepts. Seven contractors participated in the original concept definition effort. Demonstration of prototypes will be completed with FY 93 funding. FY 94 funding by ARPA will complete preparations for possible future transition to the Army.
- Accomplishments:**
- System effectiveness was analyzed for a variety of threats, scenarios, and conditions.
 - Contractor developed brassboard systems were developed and evaluated in tracker field trials. Technical approaches were validated.
 - Contracts have been awarded for the competitive prototype phase.
- BTI Funding (\$ millions):**
- | | |
|--------------------|-------|
| FY 1992 and prior: | 37.5M |
| FY 1993: | 5.2M |
- Project transition plan:** The minefield command and control part of this project is complete and has transitioned to the Wide Area Mine program. Project Direction for AHM transitioned to ARPA in accordance with a draft MOA between BTI, ARPA, and the Army. The Army will address command and control issues critical to the use of the wide area mine concept in FY 1994 under the Intelligent Minefield program.
- Executive Agent:** The AHM project is managed by the ARPA Land Systems Office. Technical assistance is provided by ARDEC, Picatinny Arsenal, NJ.
- Contractors:** Textron Defense Systems, Wilmington, MA (Prime)
Ferranti International Plc, UK (Prime)

IES/BTI

- Project:** Imagery Exploitation System (IES/BTI)
- Project Objective:** The purpose of the IES/BTI project is to apply advanced computer hardware and software technologies to the problem of image analysis to determine the tactical combat situation.
- Operational Utility:**
- Perform rapid initial screening of large amounts of sensor data and allow analysts to concentrate on the high priority tasks.
 - Improve both speed and accuracy of image analysis.
 - Facilitate the indications and warning process.
 - Real-time situation assessment, target development, & acquisition.
 - Capable of exploiting multiple resolution imagery with emphasis on low resolution/broad area search.
- Status:** Cycle 1 of a 3-cycle project has been completed. The project is now in Cycle 2. During the period a technology assessment was conducted using imagery obtained during Operation Desert Storm. The assessment shows that IES/BTI improves performance by a factor of 3 (accuracy) and 2.5 (speed) with a stand alone identification accuracy of 83 percent for battalions.
- Accomplishments:**
- Successful laboratory demonstration completed in Cycle 1
 - Prototype system achieved 83 percent accurate performance and processed 10x10 nm area in less than the time required.
 - Identified by DoD Joint Precision Strike ATD as an important technology to meet their requirement for automated exploitation of IR and SAR imagery.
- BTI Funding (\$ millions):**
- | | |
|--------------------|-------|
| FY 1992 and prior: | 16.4M |
| FY 1993: | 7.8M |
- Project transition plan:** Project direction has transferred to ARPA. A demonstration of the application of IES/BTI technology to the precision strike mission is planned for FY 1994 under ARPA funding. A prototype system has been deployed to the US Army Intelligence Center school for testing against the baseline and user feedback.
- Executive Agent:** IES/BTI has been managed by the U.S. Army Topographic Engineering Center, Ft. Belvoir, VA.
- Contractors:** Science Applications International Corporation, Tucson, AZ
Advanced Decision Systems of Booz-Allen, Mt. View, CA
MRJ, Inc., Oakton, VA
Thinking Machines Corporation, Chevy Chase, MD
Pacific Sierra Research Corporation, Arlington, VA
Los Alamos National Laboratory, Los Alamos, NM
Information Extraction and Transport, Inc., Campbell, CA
Oasis Research, Tucson, AZ

SPEAKEASY

- Project:** Advanced Technology Tactical Radio (SPEAKEASY)
- Project Objective:** A triservice program to accelerate development of a multi-band, multi-platform, digital communications system using advanced micro-electronics technologies. Provide multi-band interoperable voice and data for a wide range of existing and planned tactical radio systems.
- Operational Utility:**
- Eliminates interoperability problems
 - Reduces number of separate radios carried on missions
 - Modular versions for installations, vehicles, and manpacks
 - Reduces tri-service maintenance, training, and logistical support
 - Provides low probability of intercept and detection waveforms
- Status:**
- Speakeasy project has been transitioned to ARPA
 - Rack-mounted Advanced Development Model (ADM) prototype development has been restructured. A reduced capability ADM will be demonstrated during Phase 1.
 - ADM system design is complete. Advanced technology hardware module fabrication continues. Preliminary system software development is complete; development will continue through Phase 1.
 - Application software (waveforms) re-hosting is about 50% complete. Modifications required to integrate waveforms with system software will continue through Phase 1.
- Accomplishments:**
- Demonstrated an open digital radio signal processing architecture design that permits replacement of radio functional modules with advances in component technology.
 - Fabrication of a multi-chip module signal processor that supports the dual bus architecture has been started at Texas Instruments. This key Speakeasy module will permit multi-band operation of up to 16 waveforms.
 - Motorola developing advanced Speakeasy Information Security Module for a number of military digital processing systems.
- BTI Funding (\$ millions):**
- | | |
|--------------------|-------|
| FY 1992 and prior: | 11.1M |
| FY 1993: | 9.0M |
- Project transition plan:** Early BTI participation in the advanced development phase accelerated the application of selected functional module technologies and supported early insertion into the design. Direction of the project has transitioned from BTI to ARPA. ARPA funding will complete the technology insertion begun by BTI.
- Executive Agent:** Air Force Rome Laboratory, Griffis AFB, NY.
- Contractors:** Haseltine (Prime), Hughes, IBM, TRW, SCITEC Electronics, Inc., Texas Instruments, and ViaSat, Inc.

DIRCM

Project: Directed Infrared Countermeasure System Prototype (DIRCM)

Project Objective: The purpose of the BTI DIRCM project is to develop and demonstrate directional, multiple wavelength, active source infrared countermeasures configured for helicopters, attack aircraft, and transport aircraft.

Operational Utility: Enhanced survivability in the presence of advanced air-to-air and surface-to-air IR guided missiles

Status: The countermeasure laser has been demonstrated at the fundamental wavelength and operational power level. It will be demonstrated at all wavelengths simultaneously in July 1993.

Accomplishments:

- A low false alarm rate, high probability of detection missile warning system was demonstrated.
- The Army transferred BTI helicopter DIRCM technology into the ongoing ATIRCM program under contract to Lockheed Sanders, Inc.
- Laboratory measurements have verified the design of a high power, room temperature, IR solid state laser.
- Diodes for pumping IR lasers have been demonstrated at a production cost of \$10 per watt (reduced from \$100 per watt).
- A full power demonstration of one of the four laser modules was performed at the fundamental wavelength in May 1992.

BTI Funding (\$ millions):

FY 1992 and prior:	34.9M
FY 1993:	4.8M

Project transition plan: The Navy assumed project direction responsibility for DIRCM with the completion of the laser full power demonstration in August 1992. The helicopter DIRCM project transitioned to the US Army CECOM Advanced Threat IRCM program. The threat warning system was previously transitioned to the A-12/A-X program. The FY 1993 funding will complete the demonstration of all major functions individually. Previously planned integration and flight testing of a complete IRCM system for attack aircraft has been deferred due to budget priorities.

Executive Agent: The DIRCM project is managed by Naval Research Laboratory, Washington, DC

Contractors: Loral Electro-Optical Systems Division, OH
Northrop Corporation, Chicago, IL
Westinghouse Corporation, Baltimore, MD
Rockwell International Missile System Division, Duluth, GA

MMS

Project: Multi-Mission Seeker (MMS) Demonstration

Project Objective: The MMS project is developing and demonstrating an advanced imaging infrared seeker that integrates state-of-the-art image processing and a classified "special signal processing" (SSP) for target acquisition, tracking, and aimpoint selection. The objective of MMS is to show that this seeker can provide a quantum jump in our ability to acquire and track targets in heavy ground clutter, an ability that is particularly important when attempting to engage fleeting and partly obscured helicopters. The project is developing the seeker head in tactical size, and will test this seeker in captive flight with processors mounted in the carriage helicopter. The tests will be conducted against a wide variety of ground targets, helicopters, and fixed wing aircraft.

Operational Utility: The combination of conventional and unique classified IR processing techniques will exploit two distinct characteristics of the target IR signature in a single seeker. The MMS approach will engage a variety of targets at long range, in heavy clutter, and in the presence of countermeasures.

Status: MMS brassboard hardware development efforts are ongoing. Delivery of the MMS hardware will be completed with FY 1993 project funds and FY 1994 Army funds. MMS hardware and technology performance will be evaluated by the Army in the Army Combined Arms Weapon System (TACAWS) technology demonstration.

Accomplishments: Baseline phenomena have been investigated. Preliminary designs have been developed. Infrared focal plane array detectors have been selected. Demonstration processors and algorithms are in development.

BTI Funding (\$ millions):

FY 1992 and prior:	7.2M
FY 1993:	12.0M

Project transition plan: Management responsibility for MMS has transitioned to the Army in FY 1993. The Army, Marine Corps, and Air Force all have potential applications for MMS technology. The first application expected is TACAWS, a program to provide the advanced technology required for the multi-service, multi-mission JAWS (Joint Advanced Weapon System).

Executive Agent: Program management for MMS is provided for BTI by the U.S. Army Missile Command, Redstone Arsenal, AL.

Contractors: Texas Instruments, Dallas, TX
Hughes Aircraft Company Missile Systems Division, Canoga Park, CA

LOCAAS

- Project:** Low Cost Anti Armor Submunition (LOCAAS) Demonstration
- Project Objective:** The objective of the BTI LOCAAS project is to develop, integrate, and demonstrate prototypes of low cost advanced submunition concepts having multiservice and multi-target applicability.
- Operational Utility:**
- Reduced system cost and cost per kill
 - High effectiveness against tanks and other armor in wide variety of tactical deployments, air defense units, and surface-to-surface missile systems
 - Anti-armor submunition for Army TACMS and MLRS and for potential use in air delivered weapons (JSOW).
- Status:** In FY 1993 the program will focus on submunition fabrication and drop test demonstrations. LOCAAS seekers were highly successful in their tower and captive flight tests and are candidates for the Army Brilliant Anti Tank (BAT) system and the Navy/Air Force Joint Stand Off Weapon (JSOW) program. FY 1993 funding completes the BTI project.
- Accomplishments:**
- Concept definition studies are complete
 - Submunition designs are complete
 - Government and independent cost analyses are complete
 - Tower tests of seekers and signal processors are complete
 - Captive flight tests of seekers and signal processors are complete
- BTI Funding (\$ millions):**
- | | |
|--------------------|-------|
| FY 1992 and prior: | 22.8M |
| FY 1993: | 15.9M |
- Project transition plan:** LOCAAS technology will be available for potential system applications in December 1993 following completion of flight demonstration and data analyses. Transition to the joint service BAT and JSOW programs is being considered.
- Executive Agent:** This project was jointly managed for BTI by the U.S. Army Missile Command, Redstone Arsenal, AL, and the Air Force Wright Laboratories, Eglin AFB, FL.
- Contractors:** Loral Vought Systems, Dallas, TX (Prime)
Martin-Marietta Corporation, Orlando, FL (Prime)

DAMOCLES

Project: Damocles Autonomous Intelligent Submunition

Project Objective: This project will demonstrate a fully autonomous submunition designed to find and destroy sparsely positioned critical mobile targets such as SCUDS, SS-21s and their support vehicles.

Operational Utility:

- Provides larger search area coverage than current submunitions
- Improves imaging and processing capability to enhance target classification in open, camouflaged, and obscured positions

Status: Damocles is in Phase 3, proof of concept demonstration. It is a continuation of prior subsystem development efforts for IR sensor, millimeter wave sensor, signal and control processor, and aeromechanical subsystems

Accomplishments: System tradeoff studies and designs were done in Phase 1. Subsystems including a parachute and parachute steering mechanism, an articulated housing, dual-mode sensors, signal processor, and the warhead were designed, built, and tested in Phase 2. Field data has been collected and algorithms have been developed and tested.

BTI Funding (\$ millions):

FY 1992 and prior:	32.7M
FY 1993:	13.7M

Project transition plan: Project direction transitioned to ARPA in FY 1993. ARPA funding will complete Phase 3 in FY 1994. The technology will be available to transition to the Army in accordance with an MOA between BTI and the Army.

Executive Agent: Program management support for Damocles has been provided by ARPA, Arlington, VA.

Contractors: Textron Defense Systems, Wilmington, MA

LOCUSP

Project: Low Cost Uncooled Sensor Project (LOCUSP), also known as Uncooled Focal Plane Array

Project Objective: The purpose of the LOCUSP project is to accelerate application and demonstration of emerging uncooled infrared detector technologies to near term tri-service sensor requirements.

Operational Utility: Eliminating the need for costly cryogenic cooling of IR detector materials will make it possible to proliferate IR seekers and viewing devices. Power requirements are reduced, and reliability and availability improved. This technology will permit the development of imaging systems that are cheap enough to be acquired in sufficient numbers to make a difference.

Status: Phase I is nearing completion. In addition to the 8 systems delivered to BTI, 15 systems were delivered to the services or other government agencies. A total of 23 systems have been configured as weapons sights, area security sensors, or driving aids.

Accomplishments: Weapons sights were evaluated successfully in the Soldier Integrated Protective Ensemble ATTD in 4Q92. Driving aids were integrated into Border Patrol vehicles and tested in 1Q93. Surveillance systems were integrated by Sandia Laboratory for US Air Force aircraft protection on air bases. A system was delivered to the Navy for integration into a fire fighter's helmet.

BTI Funding (\$ millions):

FY 1992 and prior:	22.8M
FY 1993:	1.9M

Project transition plan: Project direction responsibility transitioned to ARPA following the demonstration of the prototypes in September 1992. The first phase of the development and demonstration project is essentially complete. ARPA funding of Phase II will develop seeker sensors with emphasis on performance and producibility improvements.

Executive Agent: Program management of the LOCUSP project is provided by the U.S. Army CECOM Night Vision and Electronic Sensors Directorate, Ft. Belvoir, VA

Contractors: Texas Instruments, Dallas, TX
Alliant TechSystems, Minneapolis, MN

QUIET KNIGHT

- Project:** Quiet Knight
- Objective:** The objective of Quiet Knight Phase II is to demonstrate integrated detection avoidance technology for special operations aircraft requiring low level undetected ingress and egress through enemy air defense systems. Phase II will add off-board and on-board threat warning capability integrated with a real time route replanning capability as well as a laser radar system for improved obstacle avoidance and secondary terrain following.
- Operational Utility:**
- Provide air crew with the best picture of the terrain, obstacles, and threats; warning of unexpected threats beyond line-of-sight; and real-time route replanning to take advantage of terrain and avoid threats.
 - Fast threat identification and high accuracy location
 - Reduce emissions detectability
 - Obstacle detection and avoidance capability
 - Improve terrain masking capability
 - Increase functional redundancy
- Status:** Phase I was completed in March 1991. Phase II is underway. As directed by the FY 1993 Defense Appropriation, the Phase II effort has been modestly expanded. The Air Force SOCOM project has been coordinated with the Army so that Quiet Knight technologies can be applied to future helicopter programs.
- Accomplishments:** Phase I demonstrated the following technologies:
- Low probability of detection (LPD) terrain following
 - Digital terrain database
 - System selection of best terrain following mode
 - Integrated navigation (GPS, INS, LPD radar altimeter with stored terrain database)
- BTI Funding** FY 1992 and prior: 40.1M
(\$ millions): FY 1993: 15.1M
- Transition plan:** The project will provide integrated detection avoidance technology applicable to a variety of platforms: including Combat Talon I & II, AC-130 gunships, Pave Low helicopters, B-1B and B-2 bombers, F-15 & F-16, and others. Responsibility for Quiet Knight will transition from BTI to the Special Operations Command (SORDAC) during the spring of 1993 following the Phase II critical design review.
- Executive Agent:** Air Force Wright Laboratories, Wright-Patterson AFB, OH.
- Contractors:** Lockheed Aircraft Service Corporation, Ontario, CA; Honeywell, Albuquerque, NM; Raytheon, Tewksbury, MA; Litton Amecom, College Park, MD; BTG Inc., Vienna, VA; and Teledyne Ryan, San Diego, CA

UWB/HPM

Project: Ultra Wideband / High Power Microwave (UWB/HPM) Technology

Objective: This Congressionally mandated BTI project has two primary objectives:

- Investigate UWB radar phenomenology, compare with conventional radar designs for similar applications, and develop systems to demonstrate advanced capabilities
- Establish the susceptibility of important classes of electronic systems to UWB/HPM radiation and demonstrate an advanced HPM source.

Operational Utility: Potentially superior radar performance in applications such as detection of vehicles in forests, short range air defense, and antiship missile defense. Potential utility as a countermeasure to enemy communications, sensors, and electronically guided weapons.

Status: HPM project activity is complete. An HPM testbed source was designed and fabricated for field tests against electronic systems. Seven radar design, test, and analysis tasks have been completed.

Accomplishments: Analytical studies and laboratory field experiments related to the design of UWB radar are complete. A two-day BTI UWB Radar Technology Workshop was held at the Institute for Defense Analyses in September 1992 to share the results of this program. The results of analyses, experiments, and system point designs are being provided to DoD and industry development agencies as they become available. UWB/HPM laboratory effects tests have been completed against fuze, radio, radar, and missile guidance electronics.

BTI Funding (\$ millions):

FY 1992 and prior:	19.2M
FY 1993:	7.2M

Transition plan: The UWB radar portion of the BTI project transitioned to ARPA where it is a candidate sensor system in the DoD Precision Strike S&T Thrust and as a system for detecting targets in woods and mines in the ground. The HPM susceptibility technology program transitioned to the Air Force for continued investigation of HPM susceptibility and weapon potential. FY 1993 funding for HPM susceptibility was provided by the Air Force.

Executive Agent: The UWB radar project is managed by ARPA. The HPM project was managed by the Air Force Phillips Laboratory, Kirtland AFB, NM.

Contractors: Kaman Sciences Corporation, Albuquerque, NM
DOE Sandia National Laboratory, Albuquerque, NM
Georgia Tech Research Institute, Atlanta, GA
Naval Research Laboratory, Washington, DC
DOE Battelle Pacific Northwest Laboratory, Richland, WA
SRI, International, Menlo Park, CA

SECTION 3

BTI PROJECT STATUS REPORTS

This section provides summary status reports of selected BTI projects.

Project	Page
Navy Electrothermal Gun (ET Gun)	23
Enhanced Kinetic Energy Munition (X-ROD)	29
PREDATOR (formerly SRAW/Short Range Antitank/Assault Weapon)	35
Anti Helicopter Mine (AHM).....	40
Imagery Exploitation System (IES/BTI).....	45
Advanced Technology Tactical Radio (SPEAKEASY).....	49
Directed Infrared Countermeasure System Prototype (DIRCM).....	56
Multi-Mission Seeker (MMS) Demonstration	60
Low Cost Anti Armor Submunition (LOCAAS) Demonstration	64
Damocles Autonomous Intelligent Submunition	68
Low Cost Uncooled Sensor Project (LOCUSP).....	74
Quiet Knight.....	80
Ultra Wideband / High Power Microwave (UWB/HPM) Technology.....	85

ELECTROTHERMAL GUN DEMONSTRATION

DEFENSE AGAINST THE SEA SKIMMER THREAT

The Navy's surface ship self defense capabilities are highly stressed by supersonic, highly maneuverable, sea skimming cruise missiles that will soon be readily available to third world countries. Future threats demand improvements in surface ship anti-air warfare system detection, control, engagement, and lethality.

Upgrading existing systems to counter the threat is necessary and desirable, but new approaches and technologies that go well beyond such upgrades are also needed. The Balanced Technology Initiative (BTI) Electrothermal Gun Project is applying advanced technologies to demonstrate one

potential solution to this requirement. Electrothermal (ET) propulsion technology, coupled with advanced command guidance and smart munitions technologies, should enable small caliber weapons to defeat the anti-ship cruise missile threat. They also have potential for the near term improvement of 76mm and 5-inch gun systems. Used in 5-inch and larger caliber guns, electrothermal propellant technology can enhance the performance and effectiveness of these weapons in the Naval surface fire support, anti-ship missile defense, anti-surface ship, and anti-tactical ballistic missile mission areas.

BTI ET Gun Exploits Advanced Technology



SYSTEMS CONCEPT

The Navy ET Gun concept employs an electrothermal gun and small caliber, command guided smart munitions. A dual-band tracking radar and an electro-optic sensor will provide target and projectile flight data to a fire control

system, which in turn will generate projectile guidance commands as well as gun pointing and firing commands. Guidance commands will be transmitted to the small caliber smart munitions via a communications link.

ET Gun Systems Concept

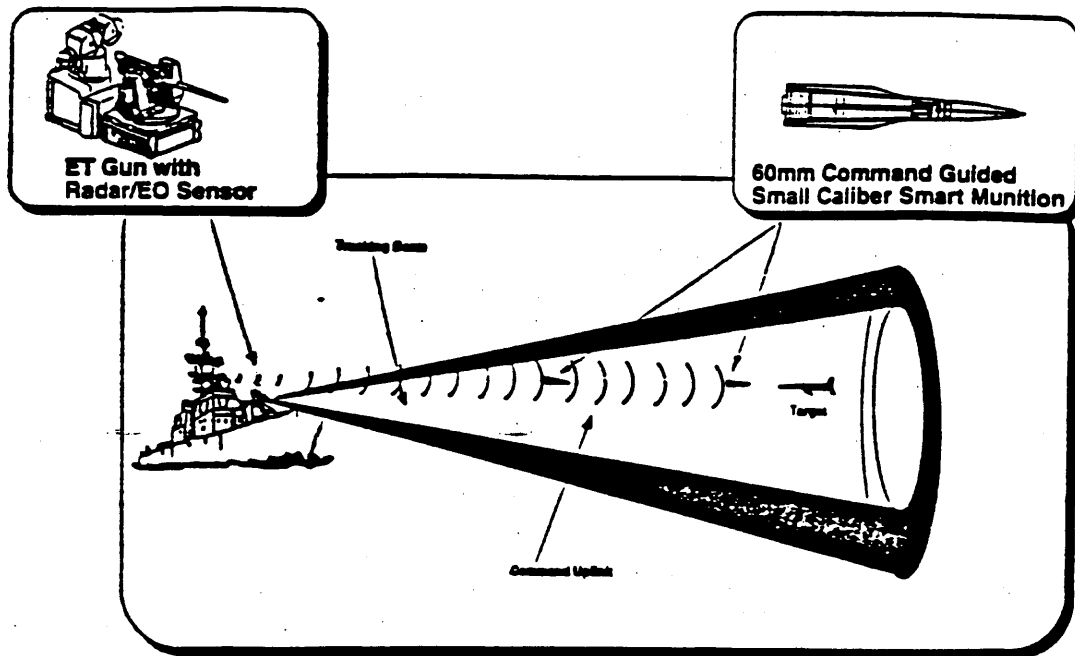

Steering commands, encoded by the communications link, are transmitted in the K-band of the RF spectrum. The smart munition receives, decodes, and responds to these commands. The projectile design

provides both thermal characteristics and sufficient radar cross section to ensure compatibility with most electro-optical and radar tracker systems.

TECHNICAL APPROACH

This project was undertaken as a systems development. Hardware development is matched with analytical studies for design definition, gun system effectiveness in the anti-ship missile defense role, and ship integration. The principle development efforts involve designing and testing an electrothermal cartridge, a 60mm gun/autoloader, and a small caliber guided projectile. This 60mm gun system is being used to provide

proof-of-principle and permit evaluation of the gun/cartridge/projectile interfaces. Each of the two propelling charge contractors will develop a suitable energetic, combustible, exothermic propellant and design an internal plasma

generating and injecting device to ignite the propellant.

The object is to control propellant combustion through control of the shape and magnitude of the

- Hardware Development**
- Electrothermal cartridge
 - 60mm gun mount and autoloader
 - Command guided projectile
 - T ASD Radar / Electro optical system

electrical firing pulse. The gun, autoloader and control assembly, have been integrated with an existing Close-In Weapon System (CIWS) gun mount to study the technology issues associated with weaponization of the electrothermal gun concept. An existing electro-optical tracking system and a commercially leased pulse power supply complete the demonstration package. A radar being demonstrated under a separate BTI project, the Target Acquisition for Ship Defense (TASD) radar, has been added to the system for simultaneous tracking of the incoming target and the outbound projectile.

The analytical aspects of the project address requirements for surface ship defense in the context of the evolving threat and the resulting weapons system requirements. These technical studies address relevant parameters including caliber, rate of fire, lethality, kinematic performance, velocities, threat detection range, tracker accuracy, reaction time, and kill assessment.

Another effort is modeling, designing, and scaling alternative pulse power

configurations that could be integrated with existing surface ship main power systems. These analyses will determine power distribution layouts, identify critical component technologies, investigate alternate power generation concepts, and examine the impact of weight and volume changes on ship space and stability. Other technical efforts assess systems effectiveness and the technologies needed to integrate the pulse power system for the ET gun with existing ship power plants.

Integration of the major systems components and subsequent progressive testing will be conducted at facilities of the Naval Surface Warfare Center in Dahlgren, Virginia.

The final event of the currently funded effort is a proof-of-principle demonstration scheduled in December, 1993, using the 60mm gun and ET cartridge, a fire control system and communications data link, radar/EO trackers, and the hit-to-kill guided projectile. This demonstration will engage a subsonic maneuvering target in a live fire test.

DEVELOPMENT STATUS

The Navy ET Gun project began with the ship integration studies in FY 1990, and excellent progress has been made in the design, fabrication, integration, and testing of all system components. Development contracts for the ET cartridges were awarded to General Dynamics Land Systems Division and to FMC Corporation. The first phase of cartridge development and testing has been completed. In the second phase, significant advances have been made in

ET Cartridge Objectives

Develop 60mm rapid fire ET cartridge

- Projectile mass 2.5-3.5 kg
- Muzzle velocity 1.2-1.4 km/sec
- Peak acceleration 30,000 g @ 1.2 km/sec
45,000 g @ 1.4 km/sec
- Muzzle energy 2.5 MJ max
- Elec energy input 2 MJ / 10 kv max
- Chamber pressure 70 kpsi max

Interface with ET Gun and enable high fire rate operation

ET Cartridge Accomplishments

- Approximately 130 test firings
- Higher propellant kinetic energy demonstrated
- Burn rate, pressure, and temperature controlled through pulse power modulation
- Muzzle velocity repeatability demonstrated within projectile acceleration limits
- Impedance repeatability demonstrated
- Muzzle energy varied by altering propellant composition and firing pulse amplitude

optimizing cartridge component designs, materials, propellant formula, and performance.

The rapid fire 60mm gun, designed and built by FMC, is now undergoing progressive testing. The gun includes a 10-round autoloader and a control assembly. Gun, autoloader, and control assembly were successfully integrated and tested at the rate of 190 rounds per minute with both conventional and ET cartridges by using interchangeable breech blocks. The goal is 240 rounds per minute. The

gun subsequently was mated with a CIWS Phalanx gun mount and successfully tested at a rapid firing rate using conventional cartridges to verify the structural integrity of the gun/gun mount integration. The next steps are further integration of the gun with the pulse power supply and testing with ET cartridges. Thereafter, remaining gun system integration, testing, and demonstration will be conducted at NSWC, Dahlgren Division.

The General Electric Re-entry Systems Department was awarded a contract for projectile studies and analyses and for the design of a projectile, a fire control system (FCS), and a communications link to provide steering commands from the FCS to the projectile. Design studies considered several terminal seeker concepts as well as hit-to-kill and fragmentation projectiles. General Electric has completed the studies/design effort and now is fabricating and conducting incremental tests of projectile components and the related FCS and communications systems.

Small Caliber Smart Munition 60mm Projectile

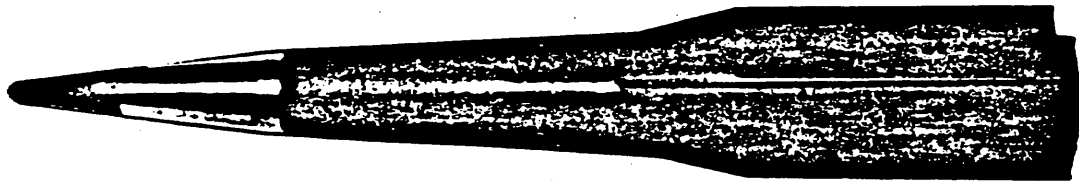

ET Gun Demonstration Schedule¹

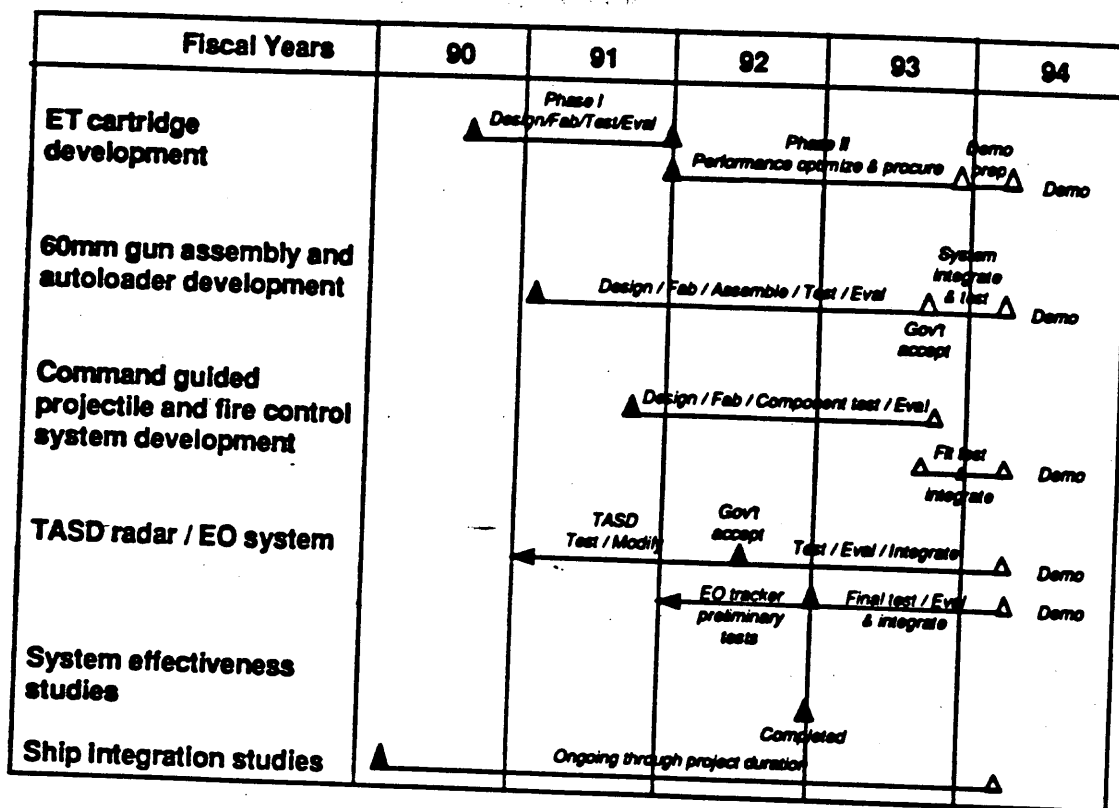

TRANSITION PLAN

The Navy plans to transition the technology developed in the BTI 60mm ETC gun project to a coordinated Defense Nuclear Agency/Navy 5-inch electrothermal-chemical gun system demonstration program. The program is scheduled to

start in FY 1994 and complete in FY 1998 with a shipboard system demonstration. The plan includes transition of the command guided projectile technology developed in the 60mm program to a 5-inch terminal defense round.

Funding Plan (\$ Millions)

	FY 1992 & Prior	FY 1993
BTI	28.1	13.7

¹ The completion of FY 1993 funded activity has slipped into FY 1994.

INTEGRATION OF T ASD

A separate BTI project, Target Acquisition for Ship Defense (T ASD) radar, was initiated to overcome the limitations of conventional ship-board self defense radar systems to provide fire control for engaging high-speed, very low altitude, low signature, maneuvering antiship missiles. The T ASD project was undertaken to demonstrate the feasibility of developing an integrated, dual-band, millimeter wavelength (K_u and W bands) radar to provide precision differential monopulse tracking for close-in weapons systems in the presence of sea clutter and multipath conditions over water.

Initial target detection and tracking is achieved at about 10 km with the K_u-band radar. Target acquisition by the narrow beam W-band radar is obtained at about 5 km. T ASD is designed to track both the

incoming target and the outgoing projectile, providing angular track accuracies on the order of 0.1 milliradians at 4 to 5 km. The dual tracking capability provides for ensuring the angular difference between the target and the projectile and generation of a fire control solution that permits the projectile to be guided so as to reduce the angular difference to zero, thereby achieving target intercept.

Identification of modifications to interface the T ASD radar with the 60 mm ETC Gun system is ongoing. When the required modifications are accomplished, T ASD will be integrated with the 60 mm gun system and used as the target/projectile tracking radar for the system demonstration scheduled in December 1993.

Current as of February 1, 1993

ENHANCED KINETIC ENERGY MUNITION

X-ROD IMPROVES EFFECTIVENESS OF ARMOR

The Balanced Technology Initiative (BTI) X-ROD project objective is to develop guided, boosted 120mm kinetic energy projectiles that can defeat enemy armor at long range. The proposed new munitions will provide fielded tanks with:

- Extended lethal range
- Improved probability of hit using guided projectiles
- Improved probability of kill given a hit from inflight boost and long rod penetrator
- Capability against helicopters

In 1985 the Defense Science Board conducted a study of U.S. armor-antiarmor capabilities. One of the conclusions was that firing accurately at greater range increases the defender to attacker kill ratio advantage. This is supported by Army Material Systems Analysis Activity studies.

This payoff is clearly indicated in the figure. The probability of kill given a shot decreases with range for current tank ammunition, but the curve is almost flat for the guided X-ROD projectile. This translates to a significant improvement in the defender-to-attacker kill ratio at longer engagement ranges.

Performance vs. Payoff

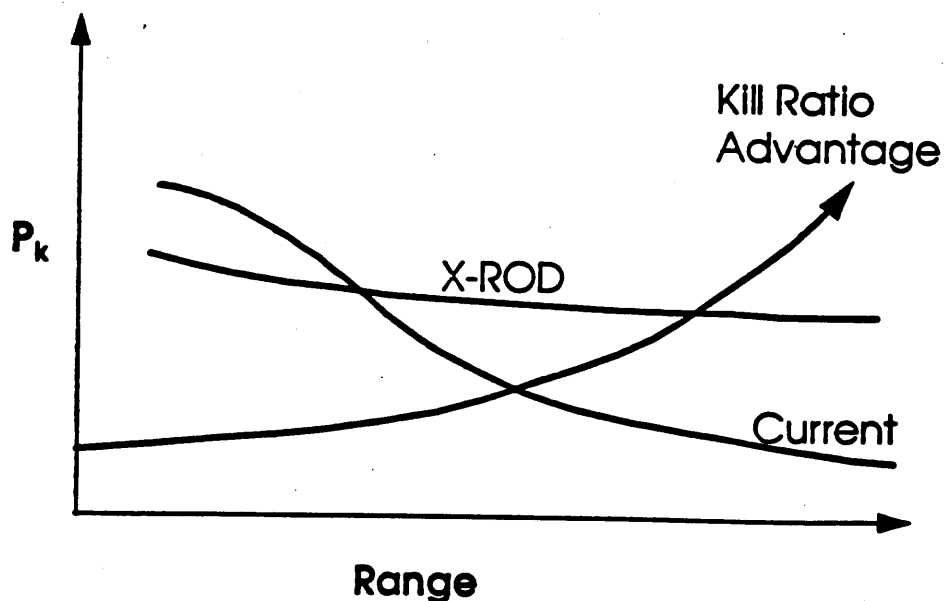

Firing first at greater range increases the defender-to-attacker advantage ratio

SYSTEMS CONCEPT

Initially, two different projectile concepts were in competition in the BTI X-ROD Phase IIIA. The AAI Corporation concept was a command guided projectile using the MTAS millimeter wave (MMW) radar to generate course correction commands. The commands were to be transmitted to a control unit mounted on the aft end of a high velocity long rod penetrator. The AAI concept was dropped because of the lack of an Army program for a radar on future tanks, as well as for technical and funding constraints.

The other concept, being developed by Hercules Defense Electronic Systems Company, is a fire-and-forget projectile. The Hercules X-ROD concept is a high

velocity, rocket boosted, long rod penetrator projectile. An on-board MMW seeker affords self contained target acquisition and terminal guidance. Divert and divert cancellation thrusters provide lateral motion toward the target as commanded by the guidance algorithms.

The Hercules X-ROD requires no modifications to the tank and is compatible with the existing fire control system. The tank crew inserts the estimated range to the target into the projectile before launch either manually or through the tank fire control system. Since the weapon is autonomous, the tank is free to maneuver immediately after firing.

Autonomous Projectile System

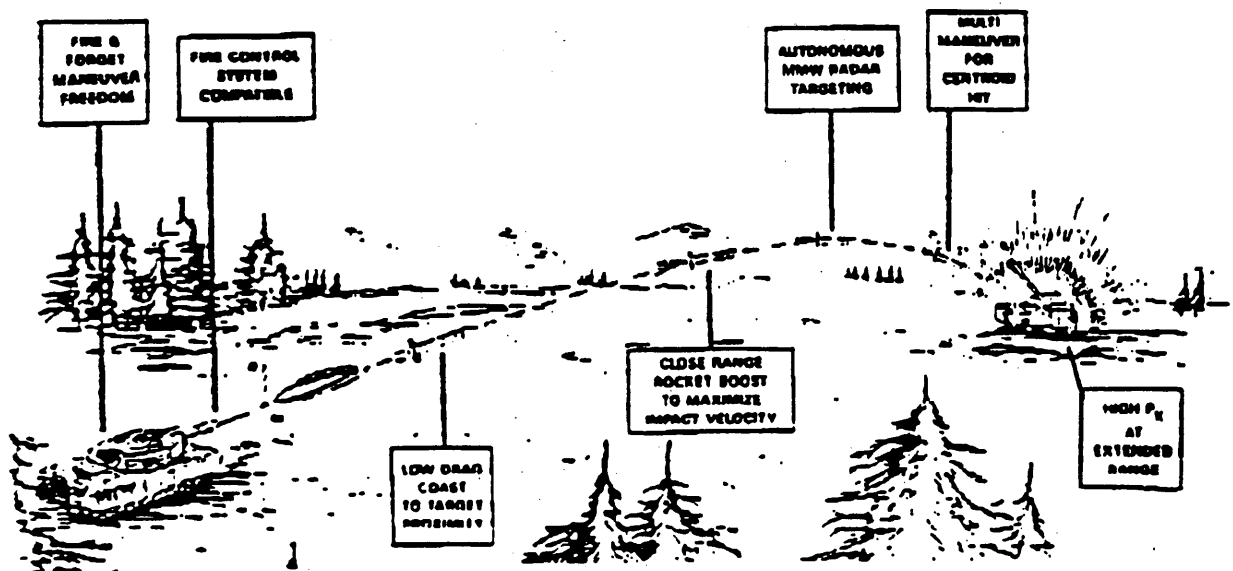

TECHNICAL APPROACH

The Hercules autonomous projectile incorporates a self-contained MMW radar seeker and guidance electronics. All the flight guidance components are carried on the projectile. After being fired from the gun, the projectile coasts toward the target. During coast the seeker is initialized and background clutter is mapped to establish projectile spin rate and vertical reference. Rocket boost is provided as the projectile nears the target, to maximize the impact velocity. After rocket boost, the target is acquired and tracked by the seeker, and divert maneuvers are performed as required to ensure a high probability of hit.

Immediately prior to impact, the projectile case is discarded allowing the bare penetrator to impact the target.

The millimeter wave guidance and control is considered high risk. The cost and complexity of this round is higher than the current tank round because of the complex guidance electronics package and the rocket booster. The higher cost is minimized by the use of a gimbal-less seeker, MIMIC and ASIC electronics packaging, and single shot maneuver thrusters. Existing systems provide target acquisition and fire control and may not always be adequate for maximum range engagements.

Hercules Fire-and-Forget Projectile

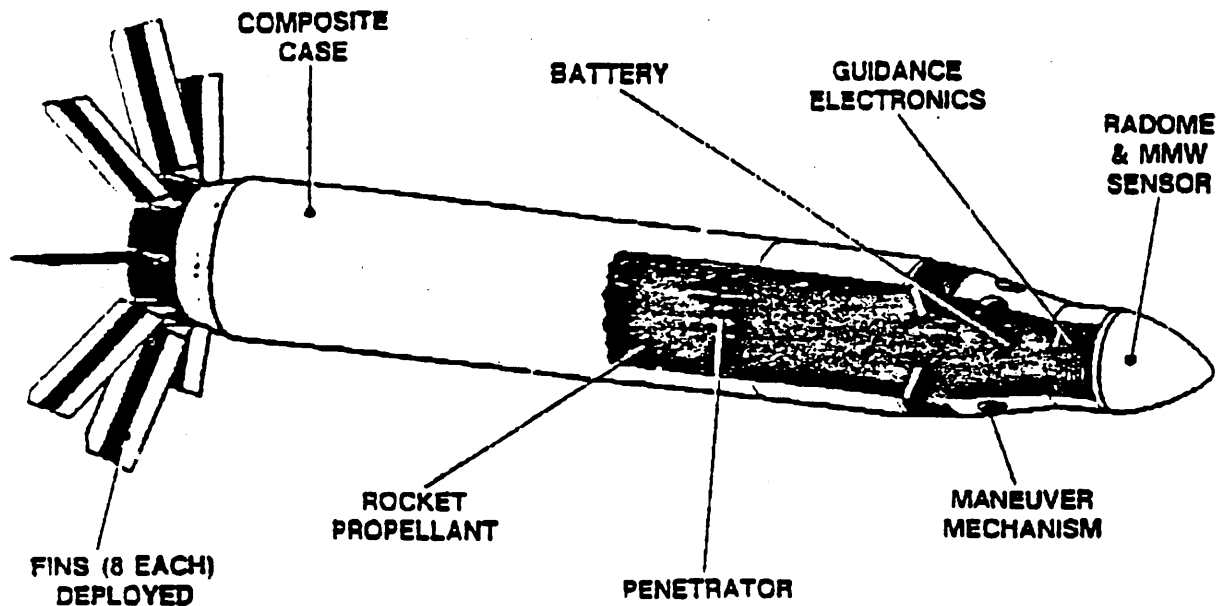

DEVELOPMENT STATUS

The X-ROD project is presently in Phase IIIA of a three phase effort which began in September 1987. Three contracts were awarded for detailed designs, simulations, and trade studies of concept alternatives. Two of the three concepts were chosen to continue into Phase II.

During Phase II, critical components were demonstrated and the designs and simulations were updated. Technical evaluations and an advanced tank automatic cannon (ATAC) system study were completed. AAI demonstrated the feasibility of their rocket motor case separation design. Separation was achieved with no major perturbation of the projectile trajectory. Radar static track of the projectile was demonstrated over short ranges. A breadboard design of the transponder car-

ried in the projectile control unit was fabricated and tested. A six-degree-of-freedom simulation of the partial system was completed. Models were based on test results, and performance and sensitivities were predicted.

Hercules built and tested a breadboard MMW seeker in Phase II. They built a form, fit, and function MMW transceiver, and tested critical MMW components for their ability to withstand high gun-launch accelerations. Seeker algorithms were developed, static and spin tests were performed, and a six-degree-of-freedom simulation of the total system was completed. Both contractors completed structural and propulsion system designs and analyses and performed wind tunnel tests.

X-ROD Program Schedule

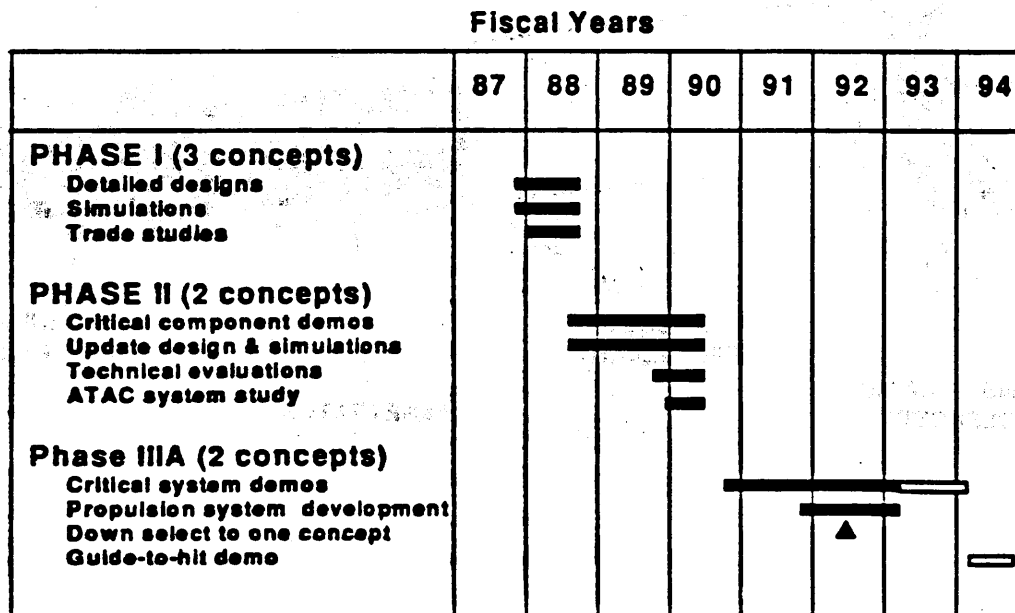

Phase III began in June 1990. Because of uncertainties remaining after the completion of Phase II, the decision was made to restructure Phase III into two subphases. Phase IIIA is a system characterization, projectile demonstration, and propulsion system development effort. During this phase projectile and guidance system characterization tests will be conducted and guide-to-hit experiments will be performed with guide-to-hit (GTH) projectiles. Completion of the GTH experiments culminates Phase IIIA as originally planned. Both Hercules and AAI began Phase IIIA, but the downselect decision in favor of Hercules was made earlier than originally intended for the reasons stated.

Significant progress was made over the past year to resolve the remaining technical issues associated with the Hercules concept. A brassboard seeker was fabricated, integrated, and tested successfully in Hercules' penthouse test facility. The seeker has been installed in the contractor's hardware-in-the-loop test facility where integration and characterization with the GTH algorithms are underway. High speed sled testing of a composite GTH radome, duplicating the conditions expected during projectile flight, were completed successfully. Maneuver

Hercules Fire and Forget Technical Issues

- Seeker performance in a real environment
 - Acquisition and tracking algorithms
 - Body motion compensation
- Radome development
- Electronics "g" hardening
- Guidance and control functions
 - Guide-to-hit, maneuver timing
- Penetration performance
 - Rocket motor case effects
 - Case separation disturbances
- Structures/propulsion
 - Launch, ignition, boost
- Close-in lethality
- Countermeasures
- Target acquisition

mechanism development has resulted in successful high-g tests of the GTH thrusters. Projectile characterization flight tests have verified the required aerodynamic properties of the GTH projectile. Progress in developing high-g electronics packaging techniques and materials produced an improved design configuration for the GTH electronics. A robust qualification test program has been established to ensure the electronics assembly's survival under gun launch loading.

TRANSITION PLAN

BTI support of the X-ROD project ends in FY 1993. There is no funding in either the ARPA budget or the Army budget for X-ROD in FY 1994 or the outyears. In the absence of funding, the plan is to minimize expenditures on the propulsion effort and use the funds saved to complete

the GTH demonstration. This would demonstrate the guidance and flight control functions. If the Army decides to complete X-ROD development at some future time, the seeker will then have to be miniaturized, and the propulsion work will have to be completed.

BTI PROJECT STATUS

Funding Plan (\$ Millions)

FY 1992
& Prior

FY 1993

BTI

71.5

20.3

Current as of March 15, 1993

PREDATOR

PROJECT DESCRIPTION

The PREDATOR, formerly called the Short Range Antitank Weapon (SRAW), is designed to replace the U.S. Marine Corps' AT-4 Antitank Weapon. The PREDATOR concept stems from in-depth studies of 30 alternative configurations. It is a man-portable, fire-and-forget, top-attack weapon with the capability of penetrating current and future armor well beyond the year 2000. PREDATOR will operate on the conventional battlefield or from within small, confined enclosures

within urban areas with greater lethality, at increased range, and with improved hit probability than currently fielded light systems. A significant advantage of the PREDATOR is its modular design that incorporates the option for direct or top attack warheads. This option enables PREDATOR to be used against main battle tanks or against reinforced concrete structures, light armored vehicles, and fortified bunkers.

OPERATIONAL CONCEPT

The Marine Corps has identified an operational shortfall in the ability of currently fielded man-portable weapons to counter the proliferating threat of advanced composite and reactive armors. PREDATOR's characteristics are designed to allow the individual infantryman to defeat advanced armored threats into the next century. The weapon's inertial guidance system and two-stage soft launch propulsion provide the gunner with the ability to fire and forget from within an enclosure. He can then successfully fight in an urban environment while limiting his exposure to the enemy and protecting himself from the backblast and noise. Considering the accuracy of PREDATOR and the time it takes to hit the target, the gunner is assured of hitting even a maneuvering tank or one that stops abruptly from high speed.

PREDATOR employs a trajectory/flight control system and a downward firing EFP

warhead to achieve accurate over-the-top kill of the target. Attacking the target's lightly armored top area increases the probability of kill. The short time of flight improves accuracy against moving targets. With a system weight under 20 pounds and a length under 40 inches, soft launch

Required Operational Capability

- Inertially guided
- Top attack -- penetrates explosive reactive armor
- 17 - 750 meter range
- Modular design
- Man portable -- less than 20 pounds, less than 40 inches
- Doubles as field handling container
- Fire from enclosures
- Minimum training required

BTI PROJECT STATUS

and delayed motor ignition permit engaging stationary or moving targets from 17 meters to 750 meters away from inside bunkers and buildings. PREDATOR requires minimum training and is simple to operate. The skills

required by the gunner are the same as required to fire the M-16 rifle. Gunner survivability is enhanced by the PREDATOR point/shoot, low firing signature, and fire and forget capabilities.

Operational Concept

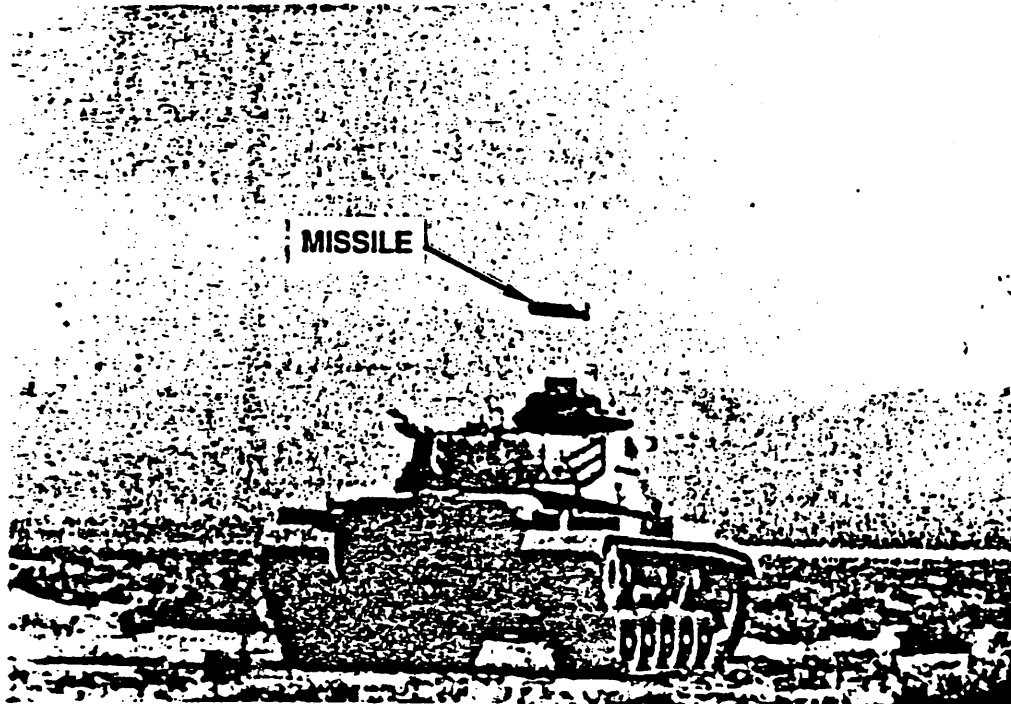

Weapon Characteristics

Guidance: Directional autopilot	Size: 140mm diameter 859mm length 19 pounds
Warhead: EFP/Top attack	Velocity: Launch: 25 m/s Maximum: 300 m/s
Fuze: Dual sensor, optical/magnetic	Time of Flight: 2.25 sec to 500 m
Propulsion: Two-stage, solid rocket	Dispersion: 1.5 milliradians
Flight control: Jet reaction control	Launch Noise: 173 dB (enclosure)

TECHNICAL APPROACH

The technical approach to PREDATOR is to integrate proven component hardware into a system that satisfies the operational requirements. Previous development of the AAWS-M warhead and continuing development of the TOW-2B warhead have contributed greatly to the PREDATOR warhead design. The directional autopilot automatically adjusts for variations in the firing conditions and makes the system simple to operate. This approach retains a capability for direct attack. Although the technical risk associated with the PREDATOR hardware components is

considered low, the project is structured to reduce these risks further.

Autopilot Features

- Control of trajectory height above target for optimum top attack effectiveness
- Crosswind correction
- Adjustment for uphill and downhill firing conditions
- Compensation for initial roll angles
- Compensation for temperature effects on rocket motor performance

Modular Design = Multi-role

Fly over / Shoot down

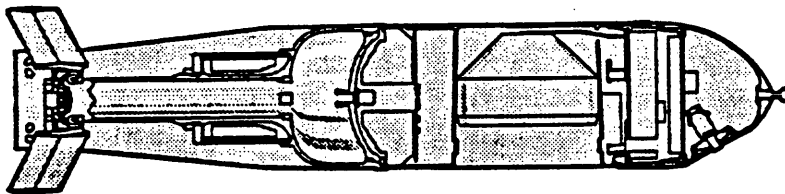

Advanced tanks

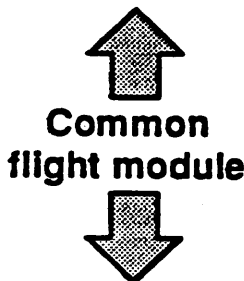

Direct attack

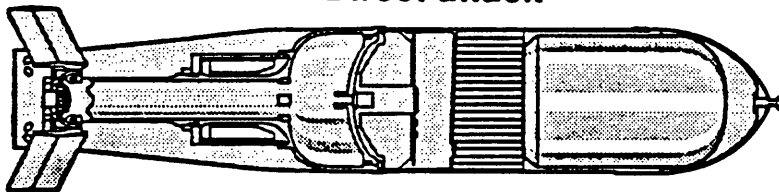

**Bunkers
Structures
Light armor
Incendary
Illumination**

BTI PROJECT STATUS

DEMONSTRATION/VALIDATION PERFORMANCE

The characteristics of PREDATOR were determined by Marine Corps requirements for weapons to allow individual Marines to destroy tanks in close combat. Antiarmor weapons should be designed to emphasize high lethality at minimum ranges. Light weapons must be man-portable, lethal, fire-and-forget, and available in large numbers. PREDATOR not only meets the requirement, but in several cases exceeds

the requirements established by the Marine Corps.

As of mid-January 1993, there were 42 tests of the PREDATOR hardware. The overall success rate to date is 83 percent. Three Marine gunners and one contractor gunner were used for the tests. The breakdown of firings, target types, and success rate is shown in the following table.

Operational Requirements Demonstrated

<u>Requirement</u>	<u>Status</u>
Effective range: 17 - 500 meters	17 meters - 750 meters
Probability of hit Stationary: 0.5 at 500 meters, 0.7 desired Moving: 0.5 at 200 meters, 250 meters desired	approximately 0.8 at 500 meters approximately 0.5 at 500 meters
Target defeat Advanced main battle tanks with reactive armor	Fully met
Weight: Less than 20 pounds	Less than 20 pounds
Length: Less than 40 inches long	35 inches
Fire from enclosure	Fully met

Demonstration/Validation Test Results

<u>Conditions</u>	<u>Firings</u>	<u>Successful</u>	<u>Percent Successful</u>
Stationary Fly-over/Shoot-down 125 meters - 1000 meters	22	17	77
Stationary Direct 333 meters - 500 meters	2	2	100
Moving target 10, 15, 22 MPH	18	16	89
Total	42	35	83

Program Schedule

SRAW-MPV

Fiscal Years	93	94	95
Target environment studies			
Warhead design Downselect			
Fuzing Technical data package			
Tactical interface			
All-up technical demonstration flights			
Critical design reviews			

TRANSITION PLAN

The BTI project will produce and test pre-EMD prototype weapon systems. Following successful completion, the project will transition to the Marine Corps to begin Engineering and Manufacturing development in FY 1993. Continuation of

the R&D program will demonstrate direct attack warhead variants for use against bunkers and other high priority, non-tank targets. These variants are of interest to the U.S. and other NATO countries.

Funding (\$ millions)

	FY 1992 & Prior	FY 1993
BTI	41.4	9.9

Current as of January 25, 1993

ANTI HELICOPTER MINES

MINE WARFARE IN THE THIRD DIMENSION

The military utility of mine warfare has been demonstrated countless times in numerous conflicts since the Civil War. The doctrine governing the employment of antiarmor and antipersonnel mines has proven successful in combat. Now technology is making it possible to extend the military utility of mine warfare to the third dimension through the advent of the smart anti-helicopter mine.

The BTI Anti-helicopter Mine Project (AHM) is the ongoing phase of the Advanced Mines Project managed for BTI by the ARPA Land Systems Office. Previously, the project demonstrated two-way radio remote control of wide area mines.

The two-way controllers are small, low cost, low power encrypted radio control units which will allow mines to receive on and off commands, pass target detection information back to an intelligence network, and permit mine-to-mine communication for attack coordination and improved control. The brassboard phase of development and testing of the mine control system was completed in FY 1991, and the results were transitioned to the Army Program Manager for Mines, Countermine, and Demolitions for further development and eventual insertion into the Army antiarmor Wide Area Mine program.

AHM SYSTEM CONCEPT

The purpose of the AHM system is to deny nap-of-the-earth flight and pop-up tactics to attack helicopters, thus eliminating their principal survival mechanism in

an air defense missile environment. Selectively deployed, the AHM will be capable of engaging low flying helicopters at altitudes up to a few hundred meters over

Textron AHM Concept

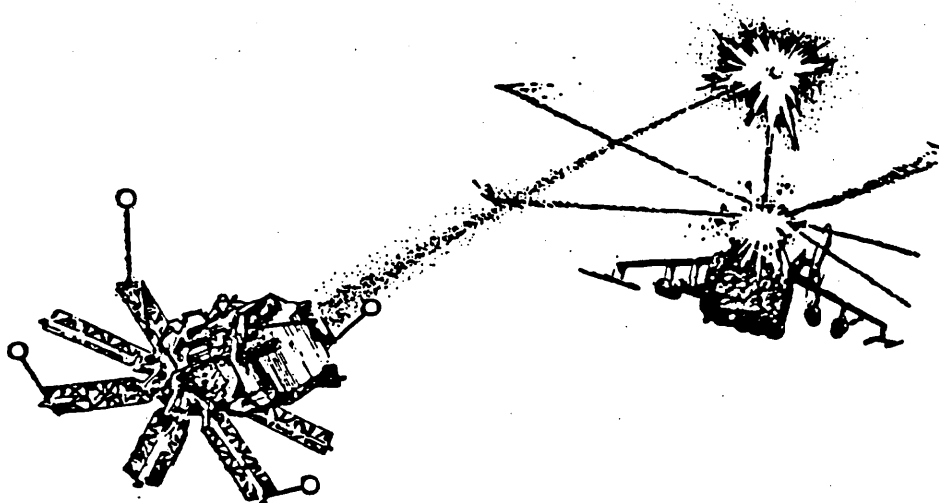

Ferranti AHM Concept

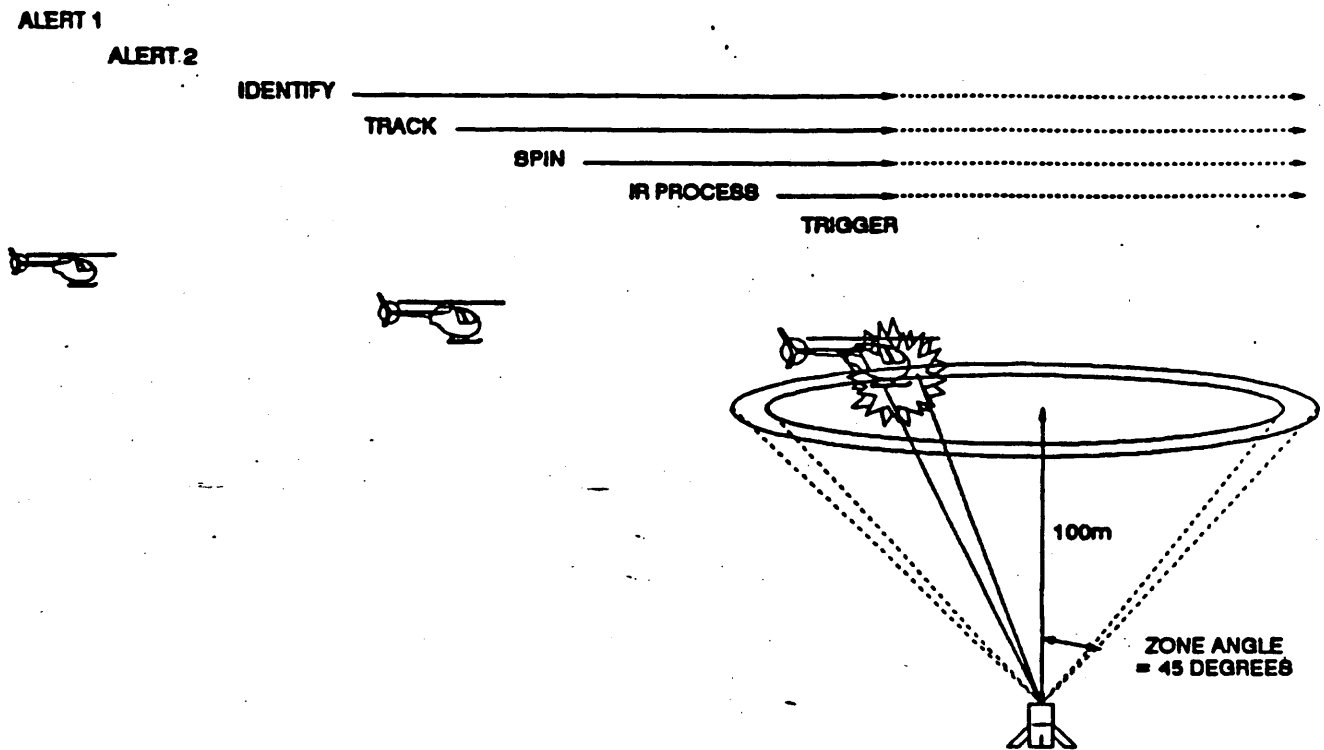

a large engagement area. They can be used to erect a lethal screen to defend an approach path and to deny enemy flight operations over ground areas such as forward area resupply points or airfields. The mines remain passive until airborne helicopters enter their zone of authority. Sensors detect, locate, and identify approaching helicopters by their acoustic signature.

Because AHM will be controllable using the two-way radio control system developed previously, the mines can be turned on and off as required to permit friendly operations and can be recovered and redeployed as needed. Intelligence collection is a matter of secondary interest. The 2-way communications capability can be used to provide intelligence and early warning information about the presence of enemy helicopters. This capability is

considered a by-product and will not be achieved at the cost of extensive modification of the mine.

AHM Employment Concepts

- Deny the use of airfields and FARP's in enemy territory
- Deny the use of landing zones in friendly territory
- Deny the use of covering terrain and present obstacles to use of approach corridors
- Provide intelligence and early warning of enemy helicopter activity
- Provide flank security to friendly maneuver and aviation forces
- Attrit and disrupt enemy forces
- Deceive the enemy concerning friendly intentions

TECHNICAL APPROACH

The major technical issue is determining the optimal trade between altitude/radius of engagement, IFF capability, operation in forest and cities, and cost. Operational and administrative issues include the definition of the most appropriate user proponents and their requirements for the employment of the system. This is being addressed through various Army Training and Doctrine Command elements.

Two different technical approaches are under investigation in the form-fit-and function phase of the AHM development. Textron Defense Systems is developing a variant of their Wide Area Mine (WAM) system. Ferranti International has devised a direct fire system. Both technical approaches must satisfy common system functional requirements and share common basic properties.

AHM System Functions	
• Mission	Identify friend and foe Kill enemy helicopters entering zone of authority
• Safe & Arm	Autonomous Remotely controlled Report status to C2 Visual indication Arm/disarm
• Communications	Command & control Safe & arm Built-in go/no-go test and indication
• Self righting on slopes up to 30 percent	
• Self defense	Low detectability Anti-tamper without self destruct Programmable self-destruct/disarm

System Properties	
• Wooden Round, WAM commonality	
• Size:	Cylinder 7-in dia, 15-in long
• Weight:	Less than 40 pounds
• Production reliability:	98%
• Operational probability:	80%
• Control probability:	99+%
• Software:	ADA or well structured ADA PDL
• Shelf life:	10 yrs (20 preferred) with 99% success
• Active life:	15 days (30 preferred)
• Dud safe:	After 4 hrs (1 hr preferred) with 99% confidence
• Emplacement time:	1 minute by hand

DEVELOPMENT STATUS

The 26-month second phase of the AHM development began in September 1991. The purpose of this phase is to demonstrate the form, fit, and function of two competing AHM concepts.

Seven contractors participated in the original concept definition efforts to define optimal system concepts. System

effectiveness was analyzed for a variety of threats, scenarios, and conditions. This phase was followed by separately contracted brassboard and prototype development. The efforts will culminate in competitive testing at Sandia National Laboratory.

The brassboard/prototype solicitation resulted in the selection of three contractors: Textron, Ferranti, and Texas Instruments. Contracts were awarded in June 1989.

Preliminary testing of the contractor brassboard systems in the Fall and Winter of 1990-91 led to the selection of Textron and Ferranti for the competitive prototype phase.

The competitive test and evaluation is scheduled to start in June 1993 and be completed by August 1993. One critical measure of effectiveness will be the capability of the AHM to reliably distin-

guish friend from foe. The systems will also be evaluated on acoustic tracking accuracy, aim miss vector, false alarm rate, and warhead parameters.

Mission analyses, requirements definition, technology assessment, effectiveness quantification, system concept definition, subsystem fabrication, and test planning are complete. Several high leverage technologies applicable to this program have been identified.

Both concepts are designed to cost \$10,000 or less in production.

Advanced Mines Project Schedule

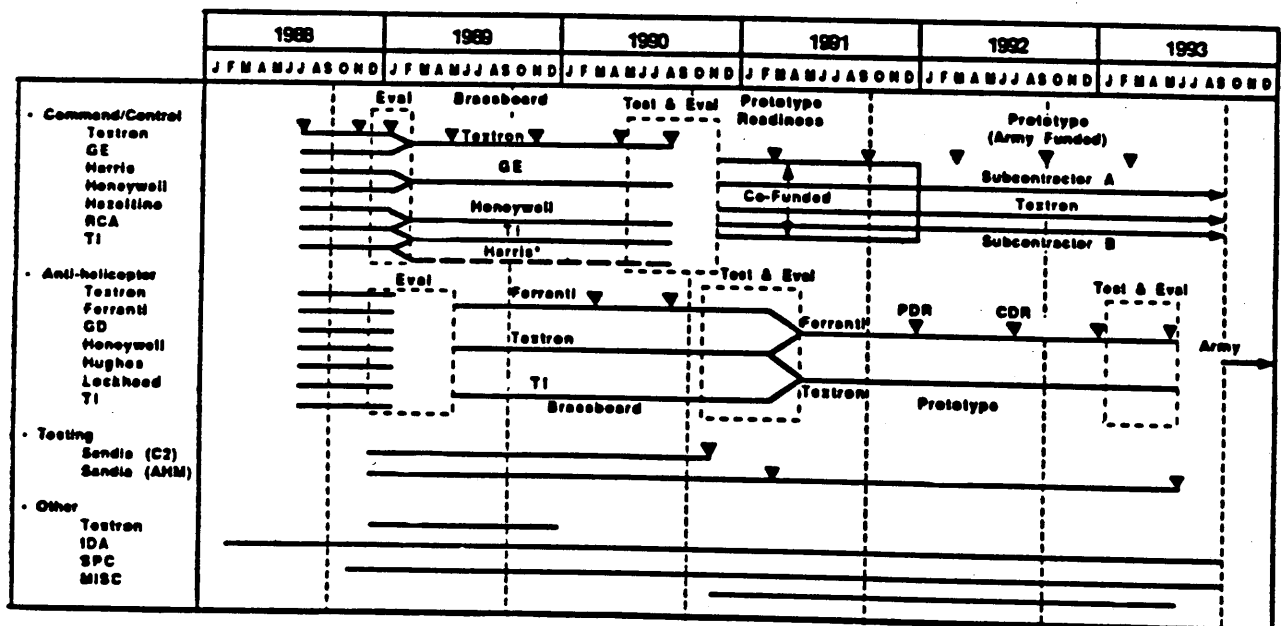

BTI PROJECT STATUS

TRANSITION PLAN

Project direction for AHM transitioned to ARPA in accordance with a draft MOA between BTI, ARPA, and the Army. The Army will address command and control issues critical to the use of the wide area mine concept in FY 1994 under the

Intelligent Minefield program. ARPA plans to continue the AHM program in FY 1994 by testing the intelligent communicating minefield capabilities of the AHM concept.

Funding Plan (\$ Millions)

	FY 1992 & Prior	FY 1993	FY 1994
BTI	37.5	5.2	
ARPA	14.3	0.0	2.0

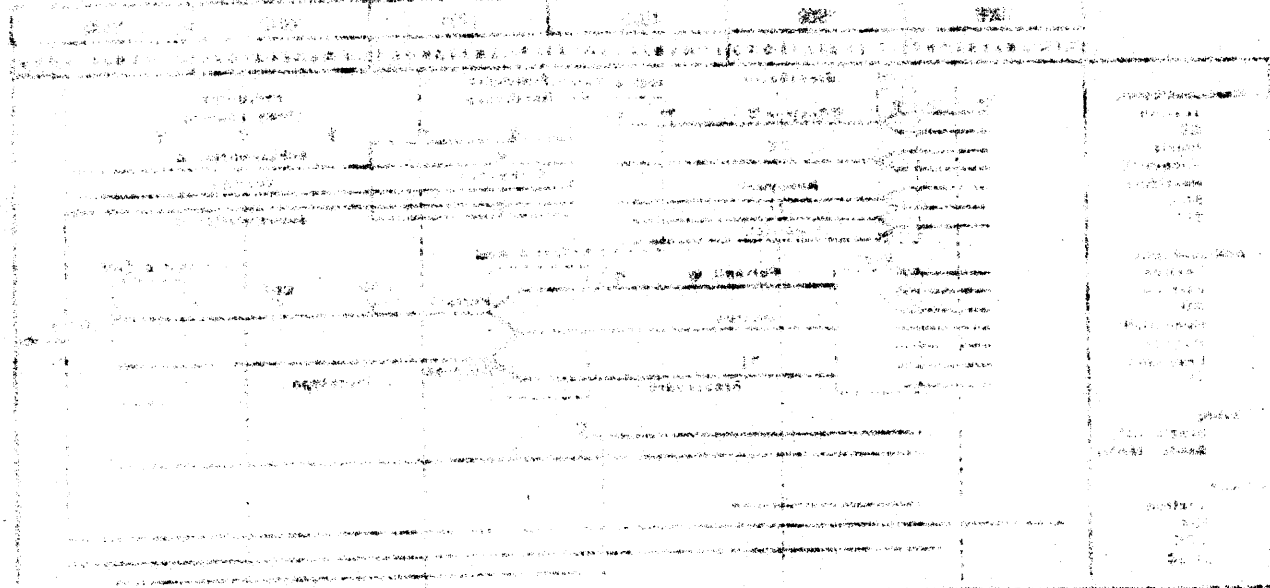

Current as of January 26, 1993

IMAGERY EXPLOITATION SYSTEM

SYSTEM DESCRIPTION

The BTI Imagery Exploitation System (IES/BTI) project applies advanced hardware and software technologies to the critical problem of tactical combat situation analysis. The objective is to demonstrate automated, real-time, first phase image exploitation that quickly detects, recognizes, locates, monitors, and tracks any enemy forces that appear in low resolution/broad area coverage synthetic aperture radar, or infrared sensor data. The IES/BTI advanced algorithms and

hardware achieve a substantial increase in speed, accuracy, and volume of sensor data processed in an operational setting that supports considerably improved battlefield management. The goal is to reduce the time to develop an intelligence assessment of the forces in a 10 by 10 nautical mile area to 5 minutes with an accuracy of 90 percent. Recent improvements in off-the-shelf hardware will enable IES/BTI processing rates to approach 1-2 minutes.

IES System Concept

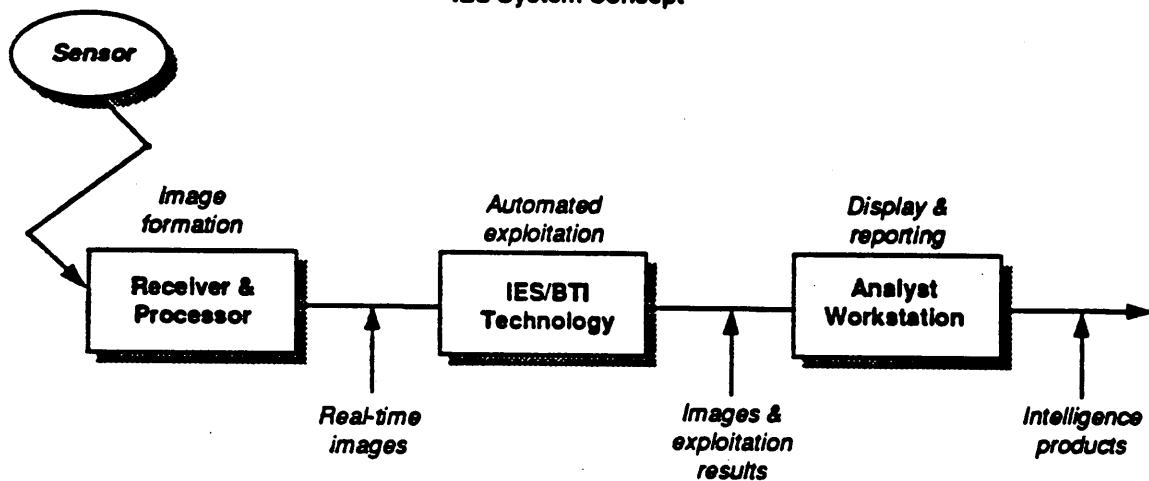

SYSTEM CONCEPT

The IES/BTI concept improves the performance of current methods of exploiting tactical intelligence information. The concept addresses major shortcomings in the exploitation of collected tactical intelligence information. The volume of synthetic aperture radar and infrared sensor data exceeds our current capability to exploit the information effectively. Real-time assessment of sensor imagery is critical to the defeat of cover, conceal-

ment, and deception and to the continuous tracking of enemy forces. IES/BTI automates the real-time analyses of multi-sensor images that are currently performed by image, order-of-battle, and intelligence analysts. The system performs an initial screening of large amounts of image data, permitting the analysts to concentrate on high priority areas and detailed evaluations of objects of interest. During peacetime, IES/BTI will facilitate indications and

warning assessments and the treaty verification process. During wartime, the IES/BTI mission will expand to provide real-time input for situation assessments, target development and acquisition, maneuver support, and the defeat of concealment and deception techniques.

IES/BTI Missions

- Support U.S. Army Corps Commander's tactical analysis of the battlefield
- Monitor and verify enemy military activity, capability, and treaty compliance
- Maintain and support a capability to respond to aggression should conflicts arise

TECHNICAL APPROACH

Automated image exploitation using only image processing techniques independent of other supporting information is extremely difficult. High false alarm rates are experienced using synthetic aperture radar and infrared sensor data.

The IES/BTI project inserts advanced technology by applying knowledge-based systems technology to image and signals intelligence and using this in conjunction with SIGINT, other collateral intelligence sources, terrain, weather, and military context data. Image and signal processing are accomplished using an open, scalable, parallel computing architecture that maximizes the use of commercial off-the-

shelf software such as the UNIX operating system and C-based language. Artificial intelligence knowledge-based reasoning is used for detection, classification, terrain analysis, and correlation of collateral information.

This robust process removes most false alarms and increases confidence in the validity of detections and unit types. Terrain and military context data are applied in a generic design that supports Defense Mapping Agency standard products. Terrain and military doctrine incorporated into IES/BTI is reviewed and approved by the Army Intelligence Agency.

Advanced Technology Insertion

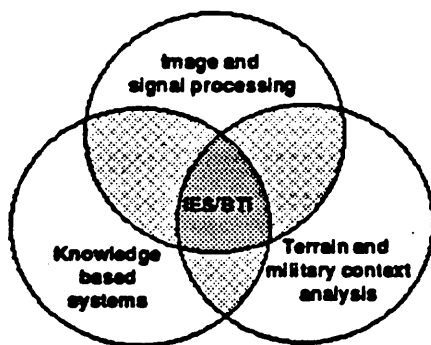

The modular architecture of the IES/BTI software is an important feature which enables changes to be made in processing modules associated with sensor input, theater of operation parameters, and topographic data types without disturbing the operation of the remainder of the system. Imagery processing is affected in only one module. If automated target recognition capability is required, one other module may need modification.

DEVELOPMENT STATUS

A laboratory demonstration of IES/BTI capability was conducted successfully during September 1990. Second echelon Soviet units deployed in a 10 nautical mile square area were identified and located in less than 15 minutes with an accuracy of 75 percent.

During late December 1990, the Commander-in-Chief for U.S. Forces Central Command requested IES/BTI technology for use in Operation Desert Shield/Storm. Due to the brevity of the conflict, IES/BTI was not able to participate; however, a Southwest Asia scenario and an additional sensor were added to the IES/BTI capabilities.

IES/BTI conducted a user technology assessment using operational data from Operation Desert Storm during FY 1992. The performance of this configuration was 83 percent accuracy with processing speed of 13 minutes for the 10x10 nautical mile area. This exceeded system performance requirements. The IES/BTI project has been identified by the OSD DDR&E Science and Technology Precision Strike

thrust area panel as a critical technology to provide a capability of near-real-time exploitation of multi-resolution SAR imagery. The completion of the entire IES/BTI program is crucial to a precision strike requirement for a fully functional automated exploitation technology.

IES/BTI technology is currently planned for insertion into the intelligence and planning (I&P) component of War Breaker and the Joint Precision Strike Demonstration. These facts, along with the changing military focus on time critical targets, has placed additional requirements on IES/BTI reasoning functionality. To this end, new technology thrusts extending IES/BTI's use of SIGINT and MTI data are being pursued. In addition, IES/BTI is moving decisively towards the addition of temporal reasoning functionality to improve image based situational assessment and targeting missions. Finally, IES/BTI is currently developing and evaluating IR detection algorithms supporting system extension to that class of sensor.

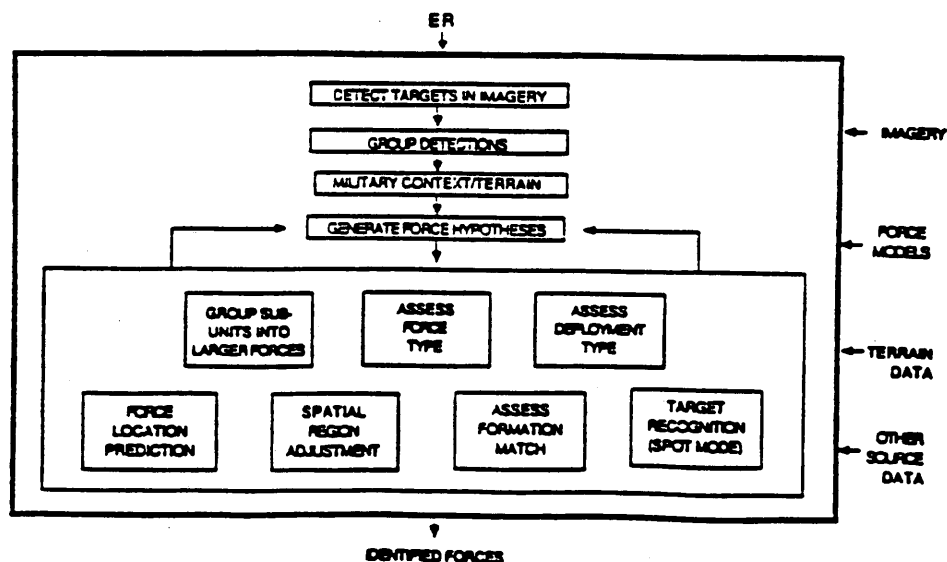

IES/BTI Processing Concept

TRANSITION PLAN

Contractors	
•	SAIC Tucson, AZ
•	Advanced Decision Systems Mt. View, CA
•	MRJ, Inc. Oakton, VA
•	Pacific Sierra Research Corporation Arlington, VA
•	Thinking Machines Corporation Chevy Chase, MD
•	Los Alamos National Laboratory Los Alamos, NM
•	Information Extraction and Transport, Inc., Campbell, CA
•	Oasis Research, Tucson, AZ

IES/BTI will provide near real-time exploitation capability to Precision Strike and Global Surveillance. This technology/system, in support of a force projection military and the Army's requirement for a "seamless" intelligence

architecture, is targeted for both the Joint and Army Corps Intelligence Architectures. IES/BTI will be demonstrated and evaluated at the EUCOM Joint Analysis Center, USAREUR's Combat Intelligence Analysis Facility, the Joint Services Imagery Processing System (JSIPS), the Imagery Processing and Dissemination System (IPDS), the JSTARS Ground Station Module, and the Army Tactical Radar Correlator (TRAC).

Project direction was transferred to ARPA in FY 1992. FY 1994 ARPA funding of IES/BTI will support the S&T Precision Strike Thrust. In the classic indications and early warning (IEW) scenario, IES/BTI is expected to support the Corps Commander's IEW needs for target development, target acquisition, and tactical analysis of the battlefield situation. A prototype system has been deployed to the U.S. Army Intelligence Center School for user testing and feedback.

Funding Plan (\$ Millions)

	FY 1992 & Prior	FY 1993	FY 1994
BTI	16.4	7.8	
ARPA			5.4

Current as of October 25, 1991

SPEAKEASY

ADVANCED TECHNOLOGY TACTICAL RADIO

CONCEPT AND OBJECTIVES

Speakeasy is a joint service program to develop a multi-platform, multi-band digital communications radio. Advanced technologies will be exploited to provide reliable, interoperable voice and data interchange for a wide range of existing and planned tactical radio systems. Greatly reduced life cycle costs are expected from the modular digital processing architecture. This cost advantage arises from reduced training, maintenance and management costs, reduced major modification costs through programmability, reduced number of inventory radios, and common "spares" inventory. Achievement of common software and hardware module design and development is crucial to successful low cost implementation of the Speakeasy concept.

Speakeasy Development Objectives

- Open and programmable processing architecture
- Allied / Multi-Service interoperability
- Backward compatible with fielded systems
- Less complex creation, integration, and testing of future waveforms
- Multilevel security
- Advanced low probability of intercept capability
- Human factors engineering / Manprint

MULTI-SERVICE REQUIREMENTS DRIVE DESIGN

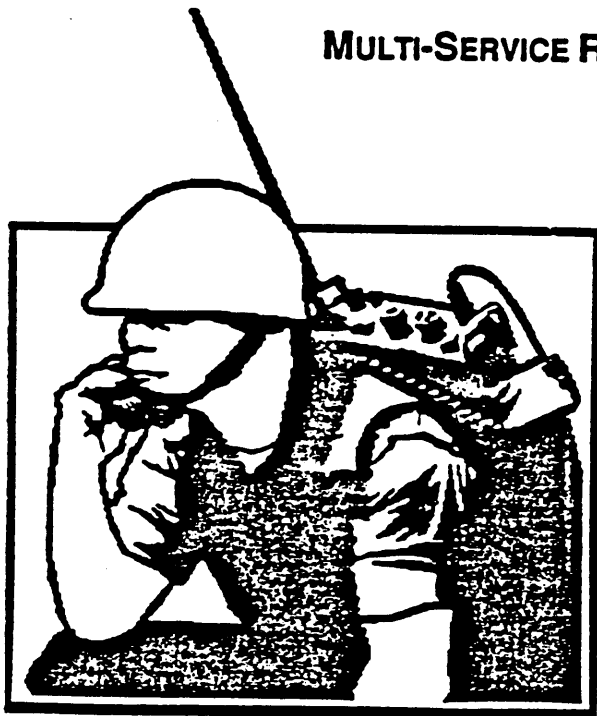

The Speakeasy system design is driven by future DoD communications needs as expressed in multi-service requirements documents. The design is also taking advantage of lessons learned in Operation Desert Storm which highlight the requirement for interoperable, multi-frequency, multi-platform communications that provide resistance to interference and interception. U.S. forces experienced difficulty communicating between services and with allied forces during the conflict because of different tactical radio frequencies and waveforms, susceptibility to mutual interference, and countermeasures.

BTI PROJECT STATUS

Speakeasy Requirements

- USAF 21st Century Tactical Air Command and Control
- US Army Battlefield Information System 2015
- US Navy Copernicus Communications Support System
- Future requirements from Joint Communications Support Elements and Marines

The modular Speakeasy design addresses this incompatibility through a common multi-band digital radio signal and data processing architecture with various

waveform options and menu-driven re-configurability. The same suite of modules will be used for all platforms. The adaptability needed to provide physically dispersed and functionally distributed command and control networks is inherent in Speakeasy functional modularity.

Waveform compatibility will be provided for HF, VHF, UHF frequencies up through L-band. This will support the integration of communications equipment such as SINCGARS, GPS, PLRS, EPLRS, JTIDS, Link 11, and others. Provisions will be made for later incorporation of SHF SATCOM, MILSTAR, and Navy UHF SATCOM into the Speakeasy architecture.

WAVEFORM COMPATIBILITY						
HF	VHF	UHF	L-BAND	C-BAND	X-BAND	NEW/ PROGRAMMABLE
*HF Modem	*SINCGARS	*Have Quick I	JTIDS	TRC-170	TSC-84A	Advanced LPI
*Paper Bounce	MSRT	*Have Quick II				*Generic Spread Spectrum
*HF ALE	FUGER-A/VHF	Have Quick IIA				*Generic Narrowband & Wideband
*STAJ	PRIG	Satum				

* To be demonstrated in Phase I

DESIGN AND DEVELOPMENT APPROACH

A single piece of equipment for multiband operation with one or more multiband antenna types is being designed around a core modular communications processing architecture. This "open" dual bus architecture builds on joint Service avionics concepts, software developed for the YF-22/23 Advanced Tactical Fighter, and Integrated Communications Navigation Identification Avionics programs. More than 25,000 lines of Speakeasy's Ada code

is being adopted from these other programs. Reuse of completed and documented radio waveform software substantially reduces the time and cost to design appropriate modules and demonstrate a prototype Speakeasy advanced development model. In addition, software code developed and documented under Speakeasy will be available for the YF-22/23 and other programs as a cost saving measure.

The latest communications component and subsystem hardware and software will be incorporated into the Speakeasy modular design. Speakeasy architecture is "open" in the same sense as the IBM personal computer. Hardware and software modules can be replaced to change functionality and to accommodate advances in processing technologies. Greater dedicated functionality can be obtained by paralleling modules or scaling up for faster processing to meet unusual communication demands.

Speakeasy development will proceed in two phases. A prime contract for Phase I was awarded to Hazeltine Corporation, Greenlawn, NY, in August 1990. Hazeltine is the system developer for the Phase I ADM architecture. As a result, a series of subcontracts have been awarded in particular areas of the system for software and hardware development.

This first phase effort is focused on demonstration of a modular processing

architecture. Various subsystem modules are being designed and fabricated, to include: a digital signal processing module, radio frequency (RF) subsystems and a multiband antenna subsystem. Selected advanced technology miniaturized components will be fabricated and evaluated for potential insertion into an advanced development model (ADM) prototype. A rack-mounted Speakeasy ADM prototype radio will be fabricated and evaluated in the Phase I development effort. The ADM will demonstrate the baseline capability of simultaneous communications with different fielded radio and data link equipment.

Miniaturization of selected Speakeasy hardware subsystems, necessary for implementation of a manpack version, will also be demonstrated following Phase I. Many of the technologies being developed in Phase I are supported by BTI.

BTI CONTRIBUTION TO SPEAKEASY DEVELOPMENT

The DoD Balanced Technology Initiative (BTI) is participating in Speakeasy first phase development by enabling design of an advanced, miniaturized ADM architecture and supporting design studies for a number of key Speakeasy modules and components intended to implement a miniaturized architecture. Successful demonstration of this higher risk advanced architecture in the first phase will significantly accelerate Phase II development and enable fabrication of full capability Speakeasy manpack communications equipment.

The RF front end development will be completed during Phase II and advanced technologies, successfully miniaturized

and demonstrated during Phase I, will be integrated into the ADM. The RF conversion module design will be finalized and custom ASIC design of Speakeasy hardware will be accomplished. FSED

Speakeasy Technologies

- Wafer scale Integrated microprocessors
- Advanced Fast Fourier Transform designs
- Direct Digital Synthesizers
- Reduced size RF architectures
- Multiband antenna designs
- Advanced battery concepts

BTI PROJECT STATUS

specifications will be produced as a result of Phase II effort. The ADM delivered at the end of Phase II will be a miniaturized

prototype version of Phase I hardware configured to support test and evaluation in the user environment.

BTI ADVANCED TECHNOLOGY INITIATIVES

Project	Description	Contractor
RF Conversion Module	Investigation and fabrication of low temperature cofired ceramic packaging technology to integrate digital, analog, RF components, and four miniaturized band-independent transmit/receive chains operating from 2 MHz to 2 GHz	Hughes or Rockwell-Collins
Direct Digital Synthesizer	Investigate the application of a state-of-the-art direct digital synthesizer using combined modulation and carrier generation	SCITEQ Electronics, Inc
Advanced Wafer Scale Digital Signal Processor	Fabricate and investigate the benefits of using ADSP modules to meet the performance requirements of the Speakeasy radio	TRW and Texas Instruments
Software Rehost Port to Advanced Development Model	Investigate and develop software code to rehost the Speakeasy software to the new ADSPs	TRW
Infrosec Module	Investigate and develop a Comsec/Transec capability to support imbedded cryptographic functions for the Speakeasy system. The eventual development will incorporate multichip module technology.	Motorola
Multiband Antenna	Investigation and prototype of HF Helix and VHF-UHF antennas	GS Inc., ITT
Multiband Antenna	Investigation and prototype of two log spiral antennas for omnidirectional coverage from 2-30 MHz and 30-3000 MHz	Ball Aerospace
Multiband Antenna	Investigation of fiber optic control of solid-state radio frequency spaced at intervals on the antenna structure. Could provide optimum radiation efficiency at any frequency in the full HF band.	Southwest Research Institute
Multiband Antenna	Investigation and prototype of excitation approach	Harris

TECHNICAL APPROACH

The Speakeasy concept is based on a highly advanced microprocessor that relies on software for signal processing. The system will be compatible with 15 currently fielded radios, spanning HF through X-band and comprising skywave, line-of-sight, tropospheric scatter, and satellite communications media. Speakeasy will be able to communicate simultaneously with any four of these radios.

Speakeasy stores much of the software in memory as parametric functional modules. The modules can be accessed via menu to reconfigure the radio, and specific waveforms are processed by specifying parametric values. The parametric composition drastically reduces the cost and time required to add new waveforms.

Waveforms are generated by a direct digital synthesizer and converted to analog form at the proper carrier frequency by the RF conversion module. The same module converts received waveforms to digital form and, with few exceptions, delivers the product to the digital signal processor.

The exceptions are relatively wideband waveforms that need special purpose digital preprocessing for operations too fast for the processor. The advanced anti-jam/low probability of intercept waveform designed expressly for improved interference and intercept resistance is a notable example.

The preprocessor also benefits existing waveforms by adaptively suppressing non-Gaussian wideband and multiple narrowband interference and by combating fading propagation via adaptive channel matching/equalization.

A terminal control function incorporates a variety of techniques to overcome interference from collocated radios. This function also enhances the man/machine interface, aids the operator in the selection of waveforms and modes, and automatically reconfigures the radio in accordance with the selections.

Reconfiguration is achieved by selecting the appropriate set of modules to match the performance of one or more of the fielded systems.

LIFE-CYCLE COST IMPLICATIONS

Each different configuration of a Speakeasy radio is constructed by selecting the appropriate set of modules from a library of standardized modules. Parametric composition of the software drastically reduces the time required to add new waveforms. Support costs are further reduced by the use of extensive built-in testing, together with self healing made possible by reconfigurability and

programmability. These features extend the average time between critical failures and reduce the number of maintenance levels to two. If Speakeasy were to eventually replace all the radios with which it is compatible, dramatic savings would result from the consolidation of multiple training, maintenance, and management costs of the different systems.

SCHEDULE

Phase I of the Speakeasy program which began in August 1990 has been restructured. A reduced capability ADM will be demonstrated in FY 1994 as previously scheduled. Phase I will focus on the design and fabrication of essential subsystems of the radio, including the digital signal processor module, RF

subsystems, and an imbedded INFOSEC subsystem. The advanced development models developed in Phase I will demonstrate the feasibility of a programmable multi-waveform capability. Following Phase I, the miniaturization of various subsystems will be integrated into a miniaturized ADM.

Speakeasy Project Schedule

Fiscal Years	90	91	92	93	94
Contract award	▲				
Advanced Development Model (ADM) analysis and design		▲	▲		
BTI advanced architecture design		▲	▲		
Complete hardware and software ADM system design and integration		▲	▲	▲	
ADM system test and evaluation				▲	▲
Multi-service demo					▲
BTI Advanced Technology Module development kick-off meetings				▲	▲

TRANSITION PLAN

Speakeasy is a tri-Service development program. BTI participation in the early advanced development model phase has accelerated the application of emerging technologies and supported the early evaluation and insertion of advanced

technologies. The services will realize the improvements offered by Speakeasy -- joint/combined interoperability, enhanced survivability, and drastically reduced costs for tactical battlefield communications -- much sooner due to BTI participation.

Direction of the project transitioned from BTI to ARPA during FY 1993 following the disestablishment of BTI. The Phase I

activity will be completed in FY 1994 with ARPA funding.

Funding Plan (\$ millions)

	FY 1992 & Prior	FY 1993	FY 1994
BTI	11.1	9.0	
ARPA			4.5

Current as of February 26, 1993

DIRECTED INFRARED COUNTERMEASURE SYSTEM PROTOTYPE DEVELOPMENT

IR-GUIDED MISSILES A SERIOUS THREAT TO AIRCRAFT

Existing airborne countermeasures no longer provide an adequate margin of protection for U.S. tactical aircraft against the increasingly more sophisticated infrared (IR) air-to-air missiles available to our potential adversaries. The Balanced Technology Initiative (BTI) began a triservice Directed IR Countermeasure (DIRCM) system development during 1989 with the objective of demonstrating prototype directional, active source jamming systems configured for helicopters, transport aircraft, and attack aircraft. The typical flight regimes and the volume and weight limitations of these distinct classes of aircraft are sufficiently dissimilar to require different DIRCM configurations. However, the basic functional designs and operational concepts are the same for the three configurations. The concept is illustrated in the attack aircraft design which has four main functional elements:

- High resolution missile warning system
- High speed digital signal and data processor
- Precision pointing/tracking subsystem
- Active laser countermeasure source

Automated DIRCM system response is initiated by detection of a threat missile launch within the surveillance volume of the missile warning system (MWS). The sensor data are processed in real time and translated into precise pointing parameters which are input into a pointing and tracking subsystem. The tracker acquires the missile and maintains a precise pointing reference for the active, modulated flash-lamp or laser countermeasure source. The modulated, high intensity energy illuminates the missile seeker with sufficient jamming power to break the guidance lock or possibly damage the seeker.

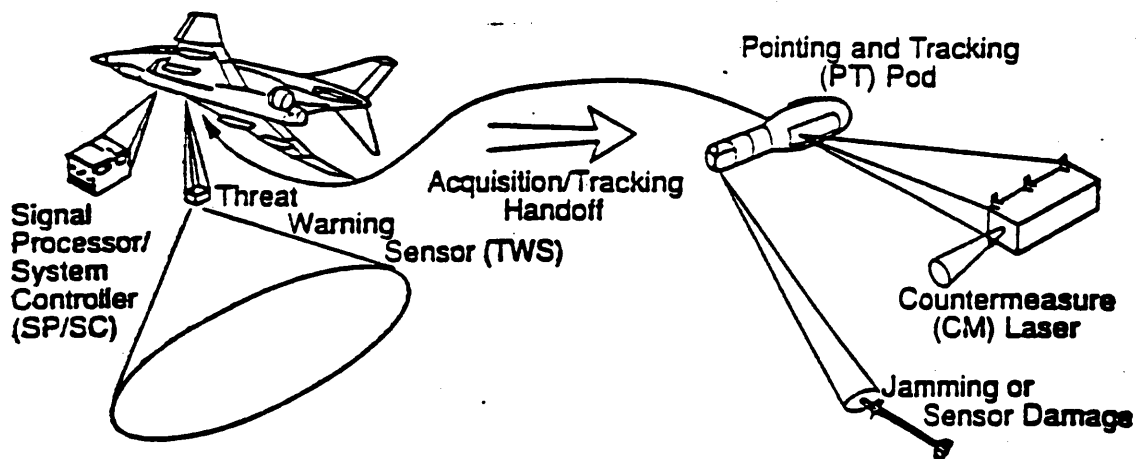

Attack Aircraft DIRCM System Concept

TECHNICAL APPROACH

Development and flight test of the three DIRCM system prototype configurations was initiated concurrently by Army, Air Force Special Operations, and Navy development agencies. Existing or near term technologies were applied to the helicopter and transport aircraft configurations, which were developed on a quick reaction capability (QRC) basis. As a result, directed, incoherent IR sources were used. The attack aircraft missile warning, processing, and pointing/tracking components were also developed using existing, but modified, technologies. However, stringent attack aircraft form factor, operational limitations, and the need for effectiveness against current and projected threats, resulted in a decision to develop and demonstrate an advanced, high power, solid state laser countermeasure source.

Three principal design issues were addressed and resolved for each DIRCM application, namely: (1) high resolution, low false alarm rate, and moderately long range threat missile detection; (2) formulation of effective, generic modulation waveforms, and; (3) design of a multiple wavelength active source. Pointing and tracking hardware, capable of being modified to achieve the desired accuracy, is available. Key capabilities demonstrated in the BTI DIRCM project include:

- Threat missile acquisition at appropriate range for countermeasures
- High resolution threat missile tracking
- Precision beam pointing
- High intensity jamming
- Near real time automated operation.

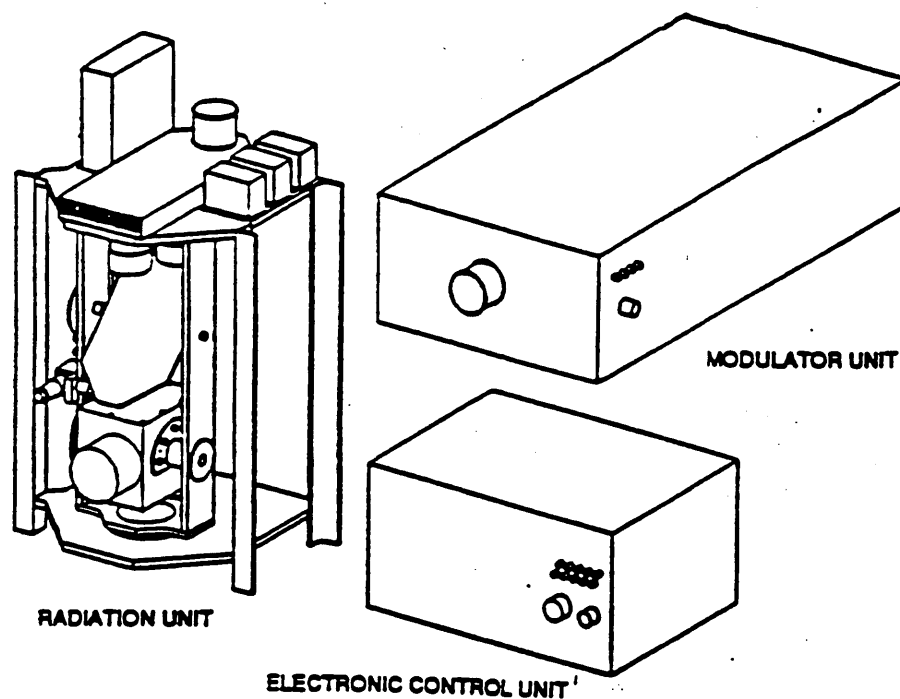

Helicopter DIRCM Components

DEVELOPMENT STATUS

The helicopter DIRCM development and testing is complete. Helicopter DIRCM techniques have been incorporated into the follow-on Army Advanced Threat IRCM (ATIRCM) system development. The following operational capabilities have been demonstrated:

- Significantly higher jammer-to-signal ratios were generated than is possible with current omni-directional countermeasure devices
- The MWS achieved precise location and tracking of the threat
- Accurate pointing of the countermeasure source was achieved using information provided by the MWS

Development and testing of the transport DIRCM is complete. Expedited flight testing of the transport version was ac-

complished using modified off-the-shelf DIRCM components. The prime contractor, LORAL Electro-Optical Systems Division, modified an Air Force missile warning receiver and a Navy countermeasure pod, integrated these using a digital software architecture, and achieved an enhanced jammer-to-signal ratio to effectively counter current IR missile threats. Flight tests of the transport version were successful. The countermeasure source modulation effectiveness was evaluated at the Air Force Electronic Warfare Evaluation Simulator facility. Follow-on engineering development of the transport DIRCM may incorporate a higher power multiple frequency laser source, such as the laser under development for the attack aircraft DIRCM.

Critical attack aircraft DIRCM components are being fabricated and tested prior

DIRCM Laser Development Schedule

Fiscal Years	90	91	92	93	94
Contract award	▲				
Advanced Development Model (ADM) analysis and design	▲	—	▲		
BTI advanced architecture design		▲	—	▲	
Complete hardware and software ADM system design and integration		▲	—	—	▲
ADM system test and evaluation				▲	▲
Multi-service demo					▲
BTI Advanced Technology Module development kick-off meetings				▲	▲

to integration into a prototype system. A staring focal plane array for the MWS has been demonstrated to obtain longer detection range with a low false alarm rate. Computer simulations have verified the performance of a countermeasure modulation scheme against a variety of threat missile types. A feasibility demonstration of the countermeasure laser was conducted at operational power and fundamental wavelength in March 1993.

It will be demonstrated at all planned wavelengths in July 1993. The attack aircraft DIRCM is obtaining pointing and tracking hardware from the Army ATIRCM program. The FY 1993 funding will complete the demonstration of all major functions individually. Previously planned integration and testing of a complete IRCM system for attack aircraft has been deferred due to budget priorities.

SOLID STATE LASER COST REDUCTION

The utility of solid state lasers has been limited by the high cost of diode arrays used to pump the solid state lasers. The BTI project was structured to include a demonstration of cost reduction. Before the BTI and tri-service cost reduction activity, a diode array putting out one joule of laser energy per pulse would cost

approximately \$1.5 million. Now such a diode array can be manufactured for only \$150,000 -- a tenfold reduction. Costs have dropped from about \$100 per watt to less than \$10 per watt and could drop to \$1 per watt at higher production rates.

Funding Plan (\$ Millions)

	FY 1992 & Prior	FY 1993
BTI	34.9	4.8

Current as of April 15, 1992

MULTI-MISSION SEEKER DEMONSTRATION

SYSTEM DESCRIPTION

What is MMS?

- An advanced missile seeker matched to a multi user missile design
- A unique sensor designed for clutter rejection and target discrimination
- An opportunity to reduce logistics support costs through multi-user, multi-mission capability

The Multi-Mission Seeker project will develop and demonstrate an advanced infrared seeker for Tri-Service application to missile systems required to acquire, classify, identify, track, and terminally guide on targets. The concept incorporates

advanced infrared imaging techniques and a unique processing approach to provide lock-on-before-launch, lock-on-after-launch, and target reacquisition capabilities. The combination of different techniques in a single seeker design makes it possible to engage ground targets, and helicopters at long range in heavy clutter and the presence of countermeasures. Improved target discrimination and positive identification capabilities will reduce the probability of fratricide. The concept can be applied to the upgrade of existing systems and will support improved capabilities in future weapon systems.

MMS ADDS SIGNIFICANT CAPABILITY TO IR SEEKERS

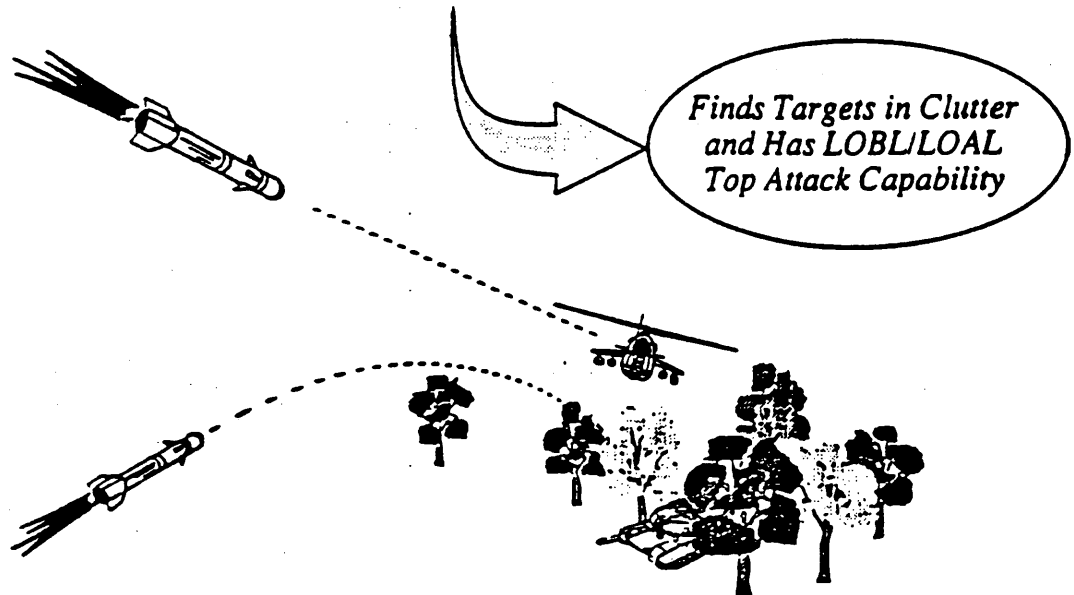

REQUIREMENT

- Potential Applications**
- Close air support munitions
 - Crew served and vehicle mounted ground-to-ground munitions
 - Attack and armed reconnaissance helicopter munitions
 - TACAWS
 - JAWS
 - Stinger upgrades
 - Theater missile defense

Present weapons systems, both in the field and under development, are designed for specific missions and targets. This limits the broader utility of the weapons, increases their costs, and results in hardware that cannot readily be adapted to other missions and systems. Missiles that can be launched from either surface or airborne platforms against both ground and airborne targets will reduce the need for dedicated weapons, increase responsiveness to unexpected targets and targets of opportunity, and enhance overall battle-field effectiveness. A common seeker for multiple applications will reduce costs through commonality in logistics support.

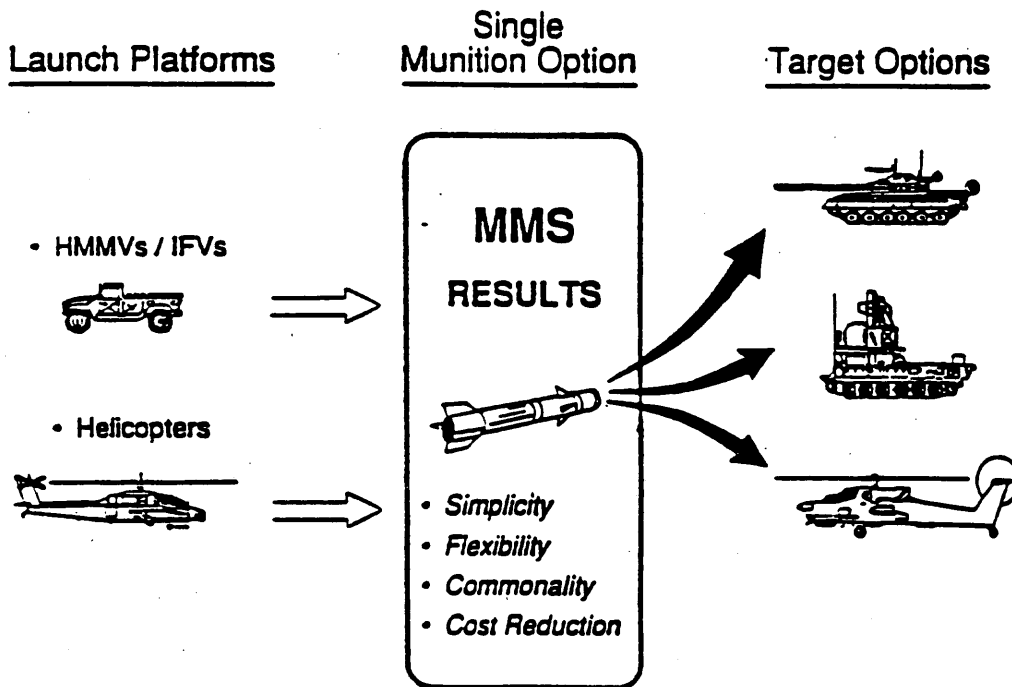

Launch and Target Options

OPERATIONAL UTILITY

Project Demonstration Objectives

- Target discrimination in clutter and adverse environments
- Extended operational ranges
- Lock-on-after-launch, lock-on-before-launch, and target reacquisition
- Automated target identification and IFF
- Solution for countermeasure deficiencies

The application of the Multi-Mission Seeker concept to selected battlefield systems will greatly improve performance, robustness of operation, and combat utility and versatility. The concept will support new capabilities and provide target acquisition, reacquisition, and discrimination in heavy clutter environments to an extent currently unavailable. The seeker has potential for employment against a wide array of ground and aerial targets.

TECHNICAL APPROACH

The primary mode of operation will be to apply special processing techniques to the infrared signal. The seeker senses and integrates two unique target aspects. When this cannot be done, the seeker will revert to basic infrared guidance. The special processing capability permits acquisition and engagement of certain targets in clutter at standoff ranges greatly

in excess of current capability. The project takes advantage of recent imaging technology developments, such as infrared focal plane array technology, large throughput compact digital signal processing hardware, and specialized algorithms. Modularity will permit multi-mission, multi-user applications.

Fiscal Years	91	92	93	94
Contract start	▲			
Program planning Information review	—————			
Hardware/Software development		—————		
Preliminary design review		▲		
Critical design review			▲	
System delivery				▲
Test and evaluation			—————	
MICOM lab testing				———
Stationary seeker testing				———
Captive flight tests				———

TRANSITION PLAN

The Army, Marine Corps, and Air Force all have potential applications for the Multi-Mission Seeker technology. The seeker and associated technologies will be transitioned to user applications as they are identified. The first application is expected to be to the TACAWS technology program in FY 1994. Through TACAWS, the MMS technology is expected to be

applied to the multi-service, multi-mission JAWS missile program in FY 1997. Project direction responsibility for MMS has been assumed by the Army. The Army Missile Command provides project management. Funding to complete the MMS demonstration in FY 1994 is included in the Army TACAWS program element.

Funding Plan (\$ millions)

	FY 1992 & Prior	FY 1993
BTI	7.2	12.0

Current as of February 22, 1993

LOW COST ANTI ARMOR SUBMUNITION

SYSTEM DESCRIPTION

The objective of the BTI low cost anti armor submunition project (LOCAAS) is to develop, integrate, and demonstrate prototypes of low cost advanced submunition concepts having multi-service and multi target applicability. The technologies involved include submunition sensor, target detection and acquisition, target classification, tracking, maneuvering devices, lethal mechanisms, and fuzing. Combinations of these technologies will enable the development of submunition concepts and prototypes with a significant

improvement in cost effectiveness over current submunitions. Both hit-to-kill and shoot-to-kill submunition concepts are being developed.

The BTI LOCAAS project focuses on low cost per kill and low unit cost. From the beginning the project has emphasized lethality and design-to-production-unit-cost. The objective is to demonstrate the desired performance with a system that will cost less than \$15,000 per submunition.

REQUIREMENT

LOCAAS addresses several approved operational requirements for systems to attack armor, surface-to-air and surface-to-surface missile launchers. This target set is categorized as Critical Mobile Targets (CMT). The combined requirements of the Army Tactical Missile System Block II Required Operational Capabilities statement and the Air Force Wide Area Antiarmor Munition General Operating Requirement result in a joint

Potential Carriers

- **Army TACMS**
- **Army MLRS**
- **Navy/Air Force JSOW**

target set composed of moving and stationary armored vehicle formations and other high value targets.

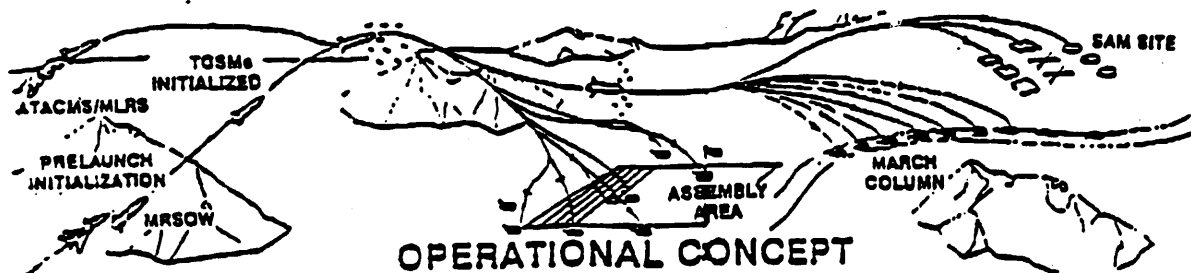

OPERATIONAL CONCEPT

The operational concept of LOCAAS is illustrated in the preceding figure. Low cost, highly effective submunitions are dispersed in the target area by munitions carriers that were initialized prior to launch. The submunitions search the area within their programmed footprint, guide to the targets, and execute a top attack

against the least protected parts. Lethality is provided by either a shaped charge warhead or an explosively formed projectile. Adaptability with Army TACMS, MLRS, and the Air Force Medium Range Standoff Weapon is a contractual part of the LOCAAS project.

TECHNICAL APPROACH

The basic technical issues are related to: "How to achieve CMT lethality at low cost?" Design-to-unit-production-cost technologies are being used to meet the cost goals.

There are two competing technical approaches to satisfying the LOCAAS requirements. The Loral Vought Systems (LVS) concept uses a laser radar seeker which is highly resistant to countermeasures, a highly maneuverable airframe, and a shoot-to-kill explosively

formed projectile warhead. Martin Marietta's design is based on the more traditional terminally guided submunition airframe. Martin uses a millimeter wave seeker with a steerable beam antenna and mature guidance and control algorithms. The warhead is a hit-to-kill shaped charge. Both seekers provide target classification capability and aimpoint selection which provide the potential for very high kill probability. Both seekers reject objects that could be false targets.

Competitive Concepts

LVS

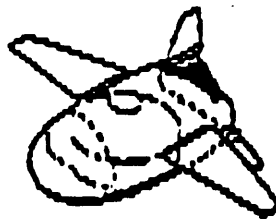

MMC

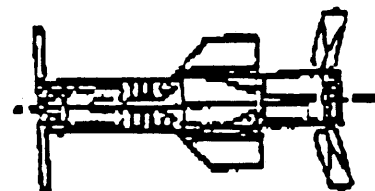

Seeker	LADAR Counter-measure robustness	MMW Steerable antenna Mature G&C algorithm
Airframe	Innovative, highly maneuverable	Traditional, TGSM variant
Warhead	EFP	Shaped charge

BTI PROJECT STATUS

DEVELOPMENT STATUS

Accomplishments to date include completion of the concept definition, design of the submunitions, and completion of independent cost analyses. Brassboard seeker hardware has been tested from the tower and in captive carry flight tests against arrays of armor in operationally representative scenarios.

In FY 1992, development focused on a seeker-only demonstration which included

tower testing and captive flight testing. This enabled the seeker technology to compete in the seeker preplanned product improvement development for the Army Brilliant Antitank (BAT) system and the Air Force/Navy Joint Direct Attack Munition (JDAM) and Joint Standoff Weapon (JSOW) programs. Submunition design demonstrations will be completed in FY 1994 as part of the FY 1993 funded effort.

Project Schedule

Fiscal Years	91	92	93	94
Program structure				
Concept definition	■			
Design	■	■		
Subsystem fabrication/test		■	■	
Submunition fabrication/ demonstration			□	□
Technologies	FY 1990 ← MMW LADAR IR/MMW	MMW LADAR	MMW LADAR	MMW LADAR

TRANSITION PLAN

The intent of the LOCAAS project was to demonstrate prototype submunitions that can be used in multiple mission applications against multiple target types. The most promising component

technologies and system concepts resulting from the project will be competitive candidates for JDAM and JSOW. The LOCAAS submunition could also meet currently unfunded requirements such as a

smart submunition for the extended range
MLRS and as part of a pre-planned

product improvement (P3I) of the seeker
for another antiarmor submunition.

Funding (\$ millions)

	FY 1992 & Prior	FY 1993
BTI	22.8	15.9

Current as of February 1, 1993

DAMOCLES

AUTONOMOUS INTELLIGENT SUBMUNITION

SYSTEM DESCRIPTION

The Damocles Autonomous Intelligent Submunition is a smart submunition that has been designed specifically to provide the greatest effectiveness against mobile launchers for surface-to-surface missiles such as SCUDS. This target was the primary reason for the present Damocles system concept, choice of sensors and algorithms for finding the target, and warhead. Damocles will also operate against mobile command posts, stationary and mobile air defense units, and arrays of light armor tactical vehicles. With a change of its modular warhead, it could also be effective against heavy armored vehicles. The submunition will be deliverable by current and emerging weapons platforms including the Autonomous Air Vehicle, the Army Tactical Missile System, the Army Multiple Launch Rocket System, and the Air Force Tactical Munition Dispenser, and the Navy/Air Force Joint Standoff Weapon (JSOW).

System Features

- Unique 4:1 glide ratio ram air parachute
- Efficient spin-vane driven scanning
- High resolution active MMW and Passive LWIR sensors
- Robust target detection, classification, and engagement algorithms
- State-of-the-art digital signal processor with parallel, multiple microprocessor architecture.
- Closed-loop platform maneuvering control system
- Novel, single-axis variable-elevation sensor/warhead aiming mechanism
- Effective 7.5 inch tantalum multiple explosively formed penetrator warhead.

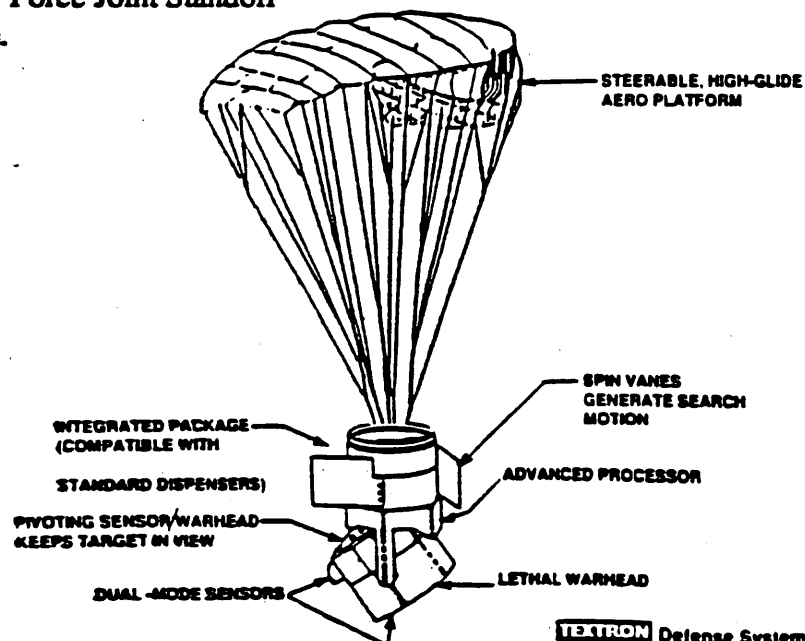

REQUIREMENT

Damocles supports AirLand Operations Doctrines. The concept overcomes several munitions deficiencies identified in U.S. Army Battlefield Development Plans including munitions lethality, system range, and target acquisition.

Current autonomous munitions are limited in their ability to detect partially obscured targets. The scenario is technically very challenging. The surface-to-surface missile launchers, components of the air defense missile units, and support elements

that comprise the target set are typically deployed in small groups over a large area. Visibility can be limited by darkness, adverse weather, smoke, dust, and other obscurants. Targets can be camouflaged, positioned in defilade, partially occluded, and protected by active and passive countermeasures. The munitions must be able to perform a broad area search, acquire and classify the target, and destroy it under all conditions of the modern battlefield.

Damocles Satisfies Army Needs for Deep Battle Attack of SSM and SAM Sites	
Army Needs	Damocles Attributes
Dispense from multiple carriers	Compatible with ATACMS, MLRS, JSOW, TMD
Provide high productivity	Multiple kills per launch
Recover from target location and delivery errors	One million square meters footprint per submunition
Attack and kill hard to find SSM/SAM targets and command posts	Against moving targets -- Maneuverable airframe, tilting warhead/sensor Against stationary targets -- High resolution sensors, advanced signal processing Against obscured targets -- Steep look-down angle, multi-aspect search
Operate in all weather	Dual sensor, less than 600 meters standoff
Low false alarm rate, countermeasures resistant	Dual sensors, multiple looks
Fire and forget	Totally autonomous operation
Low cost	Design to unit production cost \$15,000

OPERATIONAL CONCEPT

Damocles places sensors and a warhead on a rotating, maneuvering platform coupled to a high-glide parachute. The platform provides a search footprint in excess of one square kilometer to compensate for both target location and carrier delivery errors. The steep look-down aspect, relatively slow rate of descent, robust dual mode sensor, and fused data signal processing overcome the limitations of current systems and increase the probability of

target detection and identification. During the terminal phase, the sensor examines the target in multiple scans from different aspects. The processor improves classification and false target rejection performance and controls the terminal maneuvers and submunition aim point. Lethality is provided by a tantalum explosively formed penetrator aimed and fired at short range and steep target entry angles, increasing the probability of kill.

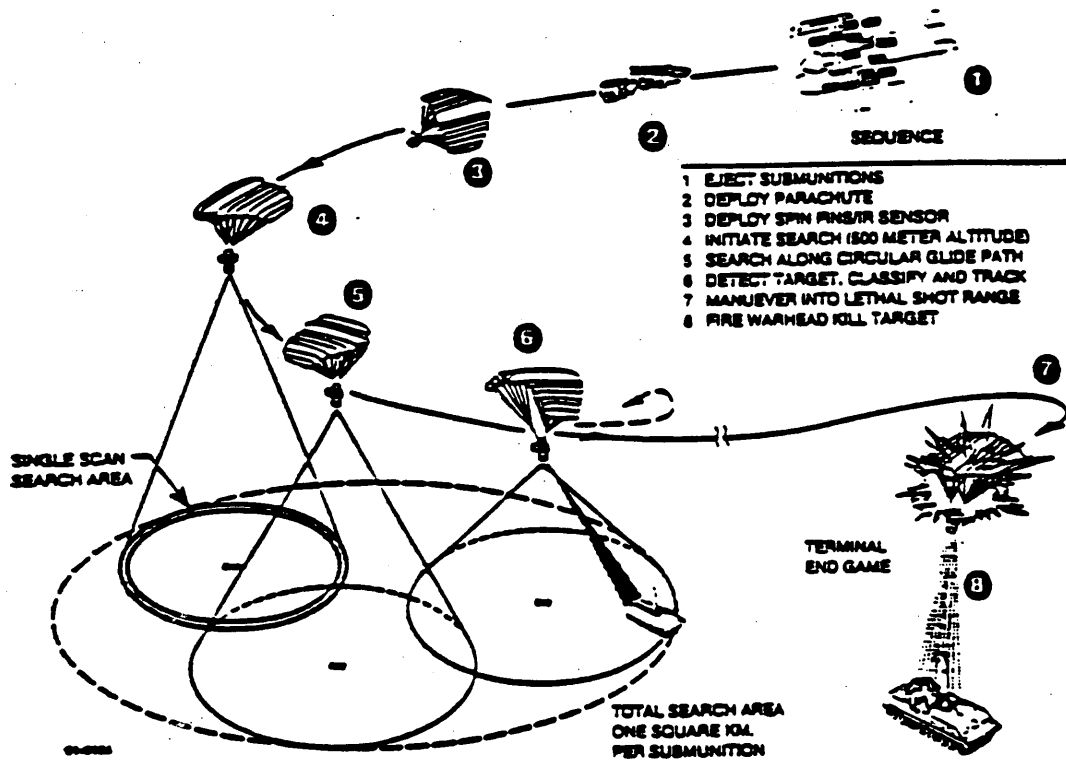

Damocles searches for, detects, classifies, and tracks the target and maneuvers to take the best shot

System Specifications

• Length:	368 mm	• Acquisition Range:	577 meters
• Diameter:	191 mm	• Lethal range:	200 meters
• Weight:	20.5 kilograms	• Sensor Suite:	Passive IR, 8-10.5 μ , Active MMW radar, 35 GHz
• Search Area:	1,000,000 square meters	• False alarm probability:	Less than 1 per square kilometer
• Search altitude:	500 meters to 50 meters	• Detection probability:	Greater than 0.9
• Scan rate:	3Hz, Passive drag fins	• Kill probability:	Greater than 0.7
• Over scan ratio:	11:1 (nominal)	• DTUPC estimate:	\$15,000 per submunition
• Engagement geometry:	360 degrees about heading		

PROJECT PLAN

The Damocles project is a continuation of previous subsystem development efforts for the prototype IR sensor, millimeter wave sensor, signal and control processor, and aeromechanical subsystems. The current effort, Phase 3, is structured to form-factor the subsystems, integrate them into a fully autonomous submunition, and demonstrate performance in live fire tests against realistic targets.

During Phase 3, the subsystems developed previously will be packaged to fit the demonstration test articles. The reconfigured warhead will be tested, evaluated, and redesigned as required to retain demonstrated performance. A production ready safe and arm device will be incorporated. The fabrication of sufficient subsystems to support the

engineering evaluation and live fire tests is also included.

The submunitions will be assembled and tested at progressively higher levels of integration. Completed submunitions will be subjected to baseline performance tests, workmanship environmental screening, and acceptance tests prior to release for system evaluation and demonstration testing.

Engineering evaluation tests will also be conducted in Phase 3. They will begin with captive flight evaluation of the sensors and data collection to support evaluation of the targeting algorithms. Captive carry tests of the integrated hardware and software will be conducted to verify performance in a variety of

operational environments. Free flight tests of an inert Damocles will verify the closed loop performance of the target engagement functions including detection, steering, and aim point control. The final

tests will verify end-to-end function except for deployment from a missile and warhead activation. Aimpoint will be proved by an on-board camera or telemetry.

Damocles Master Milestone Schedule

Fiscal Years	92	93	94	95
Subsystem development	▲—————△			
Procurement/Fabrication	▲—————△			
System Integration		▲—————△		
Components	▲			
Radar	▲—————△			
Antenna	▲—————△			
IR sensor	▲—————△			
Processor	▲—————△			
Parachute - low speed	▲—————△			
Parachute - high speed		▲—————△		▲
Test and evaluation		▲—————△		▲
Demonstrations			▲——▲	

TRANSITION PLAN

The BTI funding plan for the Damocles project is shown below. Concept development and subsystem development were funded by BTI and ARPA and constitute the basis for the current proof-of-principle phase of the development. Upon completion, the project will transition to the Army. The US Army Field Artillery School is the designated User Agency for Damocles. The Artillery School submitted a Memorandum of Support for the project to ARDEC, the development agency, in July 1991.

support the BTI request for FY 1993 funding. A Mission Element Needs Statement is required. To transition responsibility for the project to the Army and establish an outyear funding commitment, the Damocles must be added to the Long Range Army Materiel Requirements Plan. The Required Operational Capability statement should be approved by the end of the current 24-month project, prior to the Army-funded EMD program and follow-on low rate initial production.

A Memorandum of Agreement between the Army and BTIO was concluded to

Funding Plan

	FY 1992 & Prior	FY 1993	FY 1994
BTI	32.7	13.7	
ARPA			8.6

Current as of January 27, 1992

LOW COST UNCOOLED SENSOR PROJECT

WHAT IS LOCUSP?

The Low Cost Uncooled Sensor Project (LOCUSP) began as a joint ARPA/ Army investigation of infrared detector materials that function at significantly higher temperatures than photoconductive or photoelectric materials such as mercury-cadmium-telluride (MCT). A number of thermally sensitive ferroelectric materials, such as strontium-barium-titanate, and bolometric materials, such as vanadium oxide, have demonstrated uncooled infrared detector sensitivity suitable for low and medium performance IR sensor applications. LOCUSP has been referred

to in other BTIO reports as the Uncooled Focal Plane Array project.

The first uncooled IR sensor to demonstrate performance comparable to cooled IR detector equipment was the Short Range Thermal Sight developed by the Army Night Vision Laboratory in 1986. Subsequently, the Balanced Technology Initiative office joined with ARPA and the Army to increase sensitivity by 50 percent, reduce the size of individual detector elements by one-third, and increase the number of detectors in the array by a factor of eight.

LOCUSP Schedule

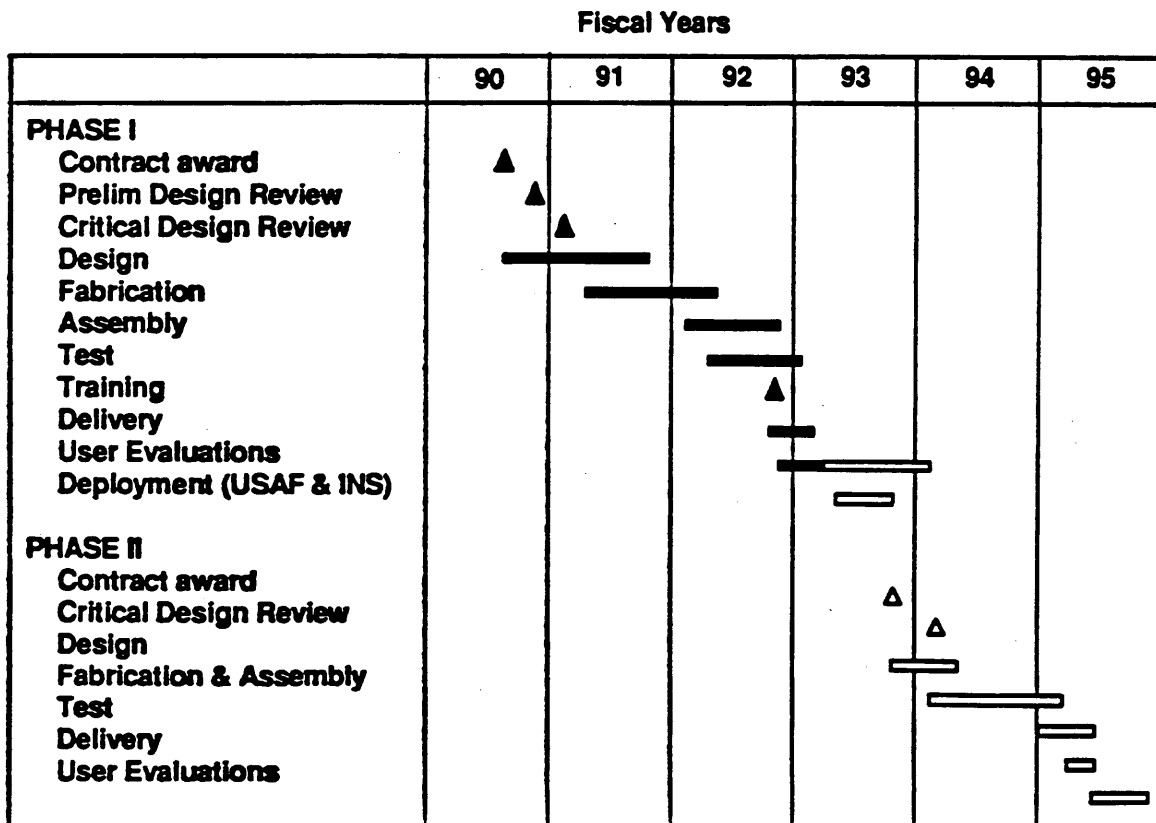

The first phase of the BTI project includes the fabrication of multiple prototype applications of the LOCUSP technology: a rifle sight (similar to the Short Range Thermal Sight developed earlier) and a remotely operated perimeter surveillance sensor. The rifle sight has also been reconfigured as a wide field of view sensor for a driving aid and for potential use in a fire fighter helmet. The first phase met its performance goals, and the systems are now undergoing user evaluations. The second phase will improve sensitivity and

producibility. The project is attempting to solve three key technical problems:

- How to achieve the sensitivity needed for medium range applications using uncooled materials.
- How to make large detector arrays reproducibly with uniform response and few dead elements.
- How to develop small, low cost, low power electronics packages that will work in an operational environment.

Surveillance System Operational Concepts

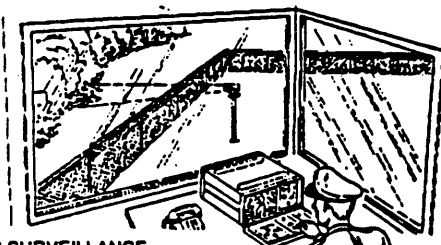

PERIMETER SURVEILLANCE

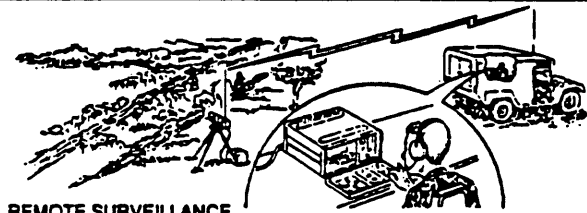

REMOTE SURVEILLANCE

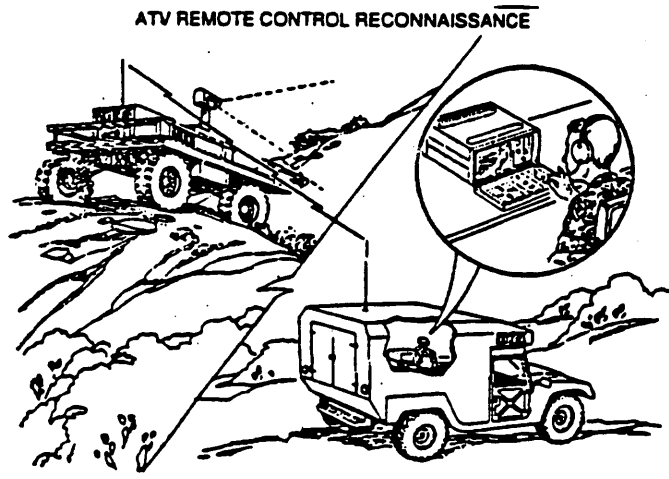

ATV REMOTE CONTROL RECONNAISSANCE

PROJECT ACCOMPLISHMENTS

The project has explored two different technical approaches to uncooled focal plane arrays. The project has demonstrated the performance of uncooled devices for driving aids, individual weapon sights, and short range area surveillance devices. Medium range capability will be demonstrated in the second phase by man-in-the-loop and autonomous munitions seekers and sensors. Current performance is adequate for the

short range applications, but higher performance will be required to meet the medium range objectives. The systems were hardened sufficiently for initial fielding by the US Air Force and the Immigration and Naturalization Service in 1993. All 23 units from the first phase were delivered by Texas Instruments between September 1992 and February 1993.

Medium-Range Thermal Sight Performance

Range	50 percent probability of detection of a man at 1000 meters
Compatibility	With M16, M203, M4, M249, M60, M136, M24
Weight	4.5 pounds
Size (inches)	4 high, 4 wide, 13 long
Operating time (one battery pack)	10 hours at 25 degrees C
Start-up time	20 seconds
Instantaneous field of view	0.5 milliradians
Total field of view	7 degrees by 9 degrees
Eye relief	30 millimeters
Exit pupil	10 millimeters
Diopter adjustment	+ 2 to - 6
Magnification	3x

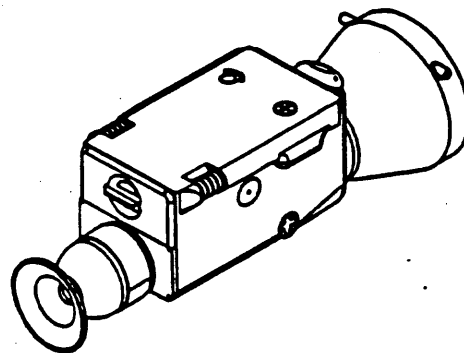
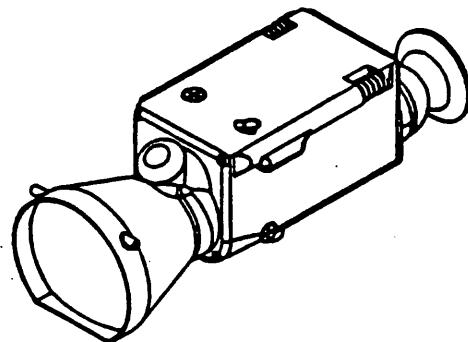

Surveillance System Performance

Range (narrow field of view)	50 percent probability of detection of a man at 1,500 meters
Weight	System: 88 lbs Sensor: 9lbs
Power	System: 50 watts Sensor: 4 watts
Start-up time	System: 20 sec Sensor: 20 sec
Voltage	100/120 VAC 50/60 Hz or 24-28 VDC
Sensor field of view	Instantaneous: 0.33 mr & 1.0 mr Wide: 13 x 18 deg Narrow: 4 x 6 deg

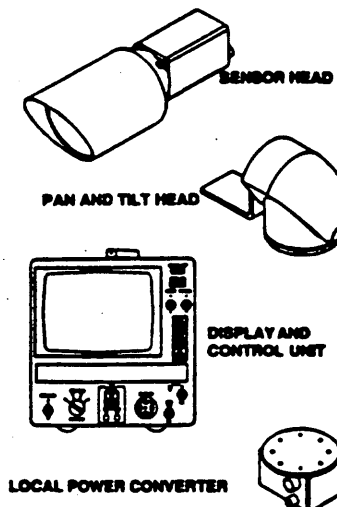

MILITARY UTILITY OF INFRARED DETECTOR TECHNOLOGY

One lesson learned during Operation Desert Storm was the major advantage of continuous day and night operations. American high technology systems such as night vision goggles, infrared targeting systems, low-light-level television cameras, and other devices enabled men and weapons systems to see and operate at night and under restricted visibility conditions.

In the future, sensors based upon LOCUSP technology will provide a lightweight (less than four pounds), long wavelength (8-12 microns) infrared imaging sensor capability independent of light level and insensitive to smoke. The technology will provide the individual soldier with infrared imaging

sensors and surveillance devices for increased physical security.

The development of uncooled infrared sensors, particularly focal plane array devices, provides a breakthrough in capability. Staring focal plane arrays further reduce complexity by eliminating the need for mechanically operated scanning

systems. The elimination of cryogenics reduces power requirements, saves weight, and improves reliability and availability. The uncooled detector technology will permit the development of moderate performance imagers

that could be acquired in sufficient numbers to make a difference. Lightweight systems that will operate for more than 10 hours on battery packs are feasible.

Prototype Applications

- Medium Range Thermal Imaging Sight
- Infrared Security Sensor
- Infrared Missile Seeker Sensor
- Infrared Autonomous Munition Seeker Sensor

IMPORTANCE OF LOCUSP TECHNOLOGY

High performance advanced systems require cryogenic cooling of the detector material to obtain the sensitivity and reduce systems noise so that low contrast targets can be detected at long range.

The Stinger, Chaparral, and Sidewinder antiair missiles use heat-seeking guidance systems based on cooled infrared detector technology. Infrared images generated by the targeting device on the F-117 Stealth Fighter were seen on television sets all over the world.

The cost and complexity of cryogenic cooling is prohibitive for many medium and short range sensor applications. Elimination of the cooling

requirement while providing adequate performance for selected applications, can reduce the cost of infrared sensors substantially. There are a wide range of

applications for readily available, reliable low-cost infrared detectors. Surveillance systems, vehicle driving viewers, weapons sights, and guidance systems for unmanned land and aerial vehicles are but a few ways these devices can be used. Systems taking advantage of this

technology would proliferate with the availability of infrared detectors that do not demand cryogenic cooling. These devices are useful in both military and civilian applications.

Advantages of UCFPA Technology
Performance comparable to cooled focal plane arrays
Reduced:
Size
Weight
Power
Cost

Potential Applications

Manportable Systems <ul style="list-style-type: none">• Weapons sights• Handheld viewers• Helmet mounted sights• Fire fighter's goggles	Seekers <ul style="list-style-type: none">• Low cost seeker• Dual mode seeker• Terminally guided submunition• Autonomous mine sensor
Vehicle Systems <ul style="list-style-type: none">• Low cost driver's aid• Unmanned aerial vehicles• Robot vision• Navigation	Fixed Surveillance Systems <ul style="list-style-type: none">• Base Security• Perimeter surveillance• Waterside security• Remote sentry

TRANSITION STATUS

There are a myriad of potential civilian and military applications for the uncooled focal plane array technology that is being demonstrated through the BTI LOCUSP project. The Air Force, the Navy, and the Immigration and Naturalization Service all have purchased additional prototype systems for evaluation. The USAF Electronic Security Center procured eight perimeter security systems which were put in the field for aircraft security. The units are undergoing evaluation for the Tactical Automated Security System. The Naval Research Laboratory procured one system

which was reconfigured for a fire fighter's helmet application, and the INS acquired six driving aid concept demonstrator systems for the Border Patrol. Other potential applications for uncooled FLIR systems are listed in the box. The project transitioned to ARPA following the demonstration of prototypes in September 1992. The first phase of the development and demonstration project is essentially complete. ARPA funding of Phase II will develop advanced sensors with emphasis on performance and producibility improvements.

Funding Plan (\$ millions)

	FY 1992 & Prior	FY 1993	FY 1994
BTI	22.8	1.9	0.0
ARPA			4.3

Current as of February 5, 1993

BTI PROJECT STATUS

QUIET KNIGHT

AVIONICS FOR CLANDESTINE OPERATIONS

The purpose of the BTI Quiet Knight project is to use current technology to demonstrate an integrated avionics suite that reduces the detectability of strategic and tactical aircraft. Passive sensor detectability is reduced or eliminated by control of radio frequency (RF) emissions, and active sensor detectability is reduced by the improved exploitation of terrain masking.

Quiet Knight Phase I has already demonstrated several technologies that are key to clandestine operations. The remaining proof of concept will be completed by the first quarter of FY 1994 and could provide significant operational payoff in five to seven years.

Quiet Knight Systems Integration

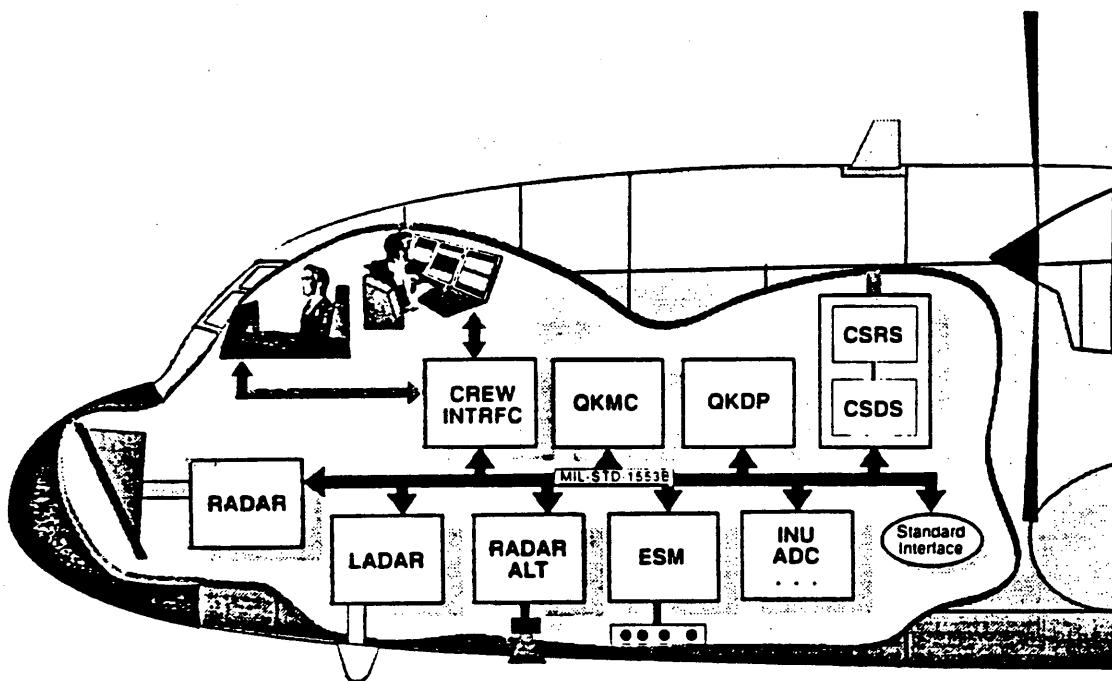

SYSTEMS CONCEPT

The Quiet Knight system will enable operational aircraft to use the large quantity of mission planning information that is available on the ground to determine a best penetration flight path to avoid detection based on pre-mission data. This information will be displayed to the crew in an easily understood manner. While in flight, the system will provide terrain following, terrain avoidance, and threat avoidance information that will make it possible to operate safely within 150 feet of the ground. Sufficient information is displayed to allow the crew to make mission decisions concerning altitude, route, and modes of operation.

Phase II will exploit the capabilities and lessons learned in Phase I and extend integrated detection avoidance technology. Although aimed primarily at special operations missions, the technologies are highly applicable to any conventional mission where detection avoidance and/or

engagement avoidance is important. The greatest near-term payoff will be in the low intensity conflict arena where the density of threat systems is relatively low. The techniques and technology are scaleable upward with increased on-board processing as the complexity of the threat environment increases. The major benefits of the Quiet Knight Phase II integrated avionics technology demonstrations will be:

- Fast threat identification and high accuracy location
- Improved threat assessment and real-time threat avoidance
- Improved obstacle detection and avoidance capability and safe terrain following and terrain avoidance as low as 150 feet above the ground
- Improved terrain masking in response to threat location data.

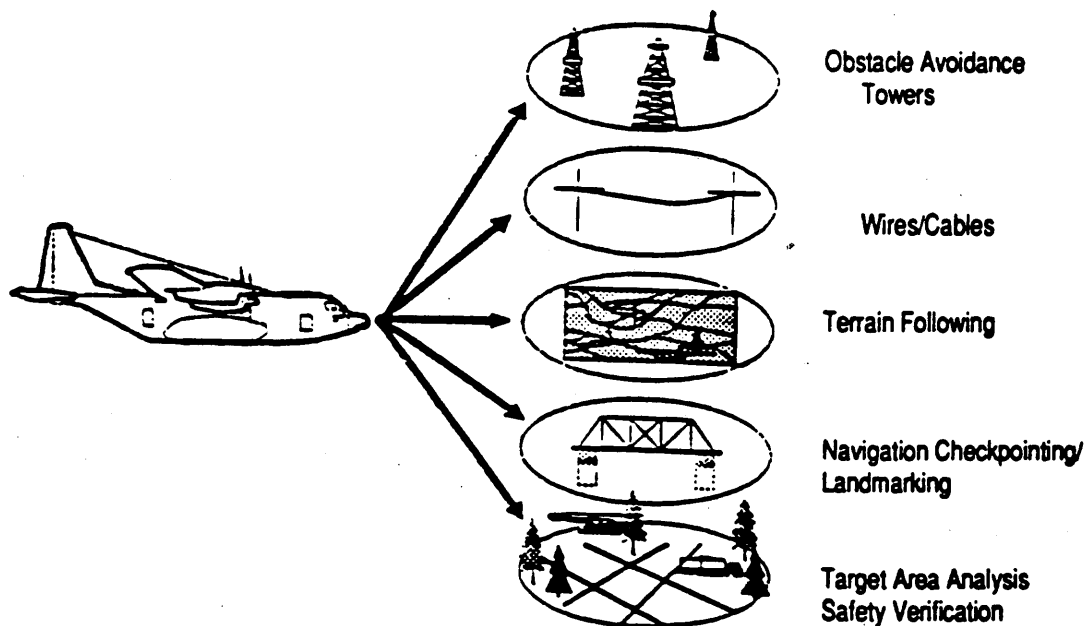

BTI PROJECT STATUS**TECHNICAL APPROACH**

The original approach of the Quiet Knight project was to integrate a low probability of detection (LPD) radar altimeter, an LPD terrain following radar, a digital map terrain system, a laser radar (ladar), and an electronic order of battle threat update system. The threat update system combines accurate bearing and passive ranging information obtained by an on-board sensor with broadcast threat data obtained from off-board sources.

From the outset it was clear that a two-phase program would be required to accomplish all the objectives within funding constraints. Phase I integrated the core avionics from Combat Talon I aircraft to establish a baseline reference of RF detectability. An LPD terrain following radar was demonstrated for an RF detectability evaluation. A digital terrain

system provided passive terrain following, terrain avoidance, threat avoidance capability, navigation, and terrain reference positioning capability using stored digital terrain elevation data and altimeter data to determine aircraft position. The final step in Phase I was the integration of the management of all the LPD sensors with a threat simulator to evaluate the system performance and in-flight route planning capability.

Phase II flight demonstrations will be structured to credibly simulate actual mission conditions. New systems to be included in the Phase II demonstrations include real-time integrated ESM, real time route replanning, and LADAR obstacle avoidance. The flight test database will be important to the services weapons systems development organizations.

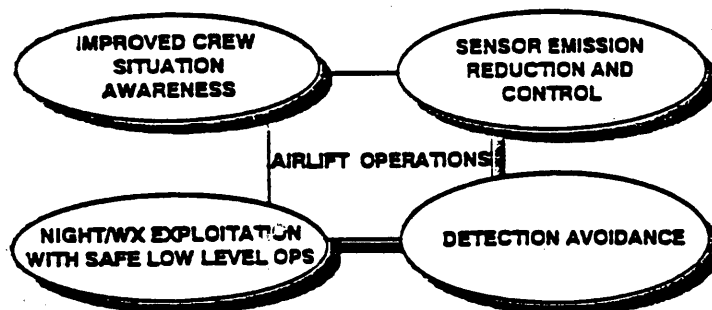
System Integration Technology Application

DEVELOPMENT STATUS

Quiet Knight is mid-way through the second phase of a two-phase program. The 23-month Phase I effort was completed in March 1991 after completing 43 separate flights totaling 188 flight hours. Quiet Knight Phase I demonstrated the ability to improve sensor management so that scanning was done only when and where required to minimize RF emissions, verify potential inaccuracies in stored terrain data, detect and account for features such as towers detected by the radar, perform look-into-turn sensing of the terrain, and exercise in-flight route replanning in response to simulated threats. New standards of performance were established for active and passive detection avoidance.

The Phase II contract was awarded in May 1991 with system technology demonstrations to be completed in late FY 1993. The Phase II system development effort was temporarily interrupted by a 90-day stop work order from 18 October 1991 to 17 January 1992. The stop work order was necessitated by Congressional suspension of FY 1992 Quiet Knight funding until credible transition planning was put in place with the Special Operations Command. The Phase I technology demonstrations were completed in January 1991. Flight demonstrations have been delayed for aircraft repairs unrelated to the project. FY 1993 funding will complete Phase I.

Quiet Knight Phase II Schedule

Fiscal Years	91	92	93	94
Program start 24-month technical effort	▲ —————			
Temporary stop work		—————		
Hardware deliveries			▲	
Aircraft repair			▬	
Baseline Flight demo 6				▬
Integrated ESM Flight demo 7				▬
Obstacle avoidance Flight demo 8				▬
Integrated system evaluation				▲
Flight test report Program completion				▲

BTI PROJECT STATUS

TRANSITION PLAN

The baseline core integration technologies that were demonstrated in Phase I are available for immediate transition. The primary demonstration equipment include a LPD radar altimeter, a LPD terrain following radar with electronically scanned array antenna, the Quiet Knight data processor, terrain data base and software to take maximum advantage of terrain shielding, and a digital memory unit.

The technologies are applicable to a variety of special operations aircraft including all variants of the C-130, Pave Low and Pave Hawk helicopters, and the CV-22. The concept also has considerable utility on bomber, fighter, and attack aircraft of all types. Special operations aircraft present the highest potential for near-term transition of detection avoidance techno-

logy. The Special Operations Forces are facing an increasingly difficult problem of executing both clandestine and low intensity conflict missions, due to the technologically sophisticated threat warning and communication systems being proliferated throughout the world. The Combat Talon P3I will apply Quiet Knight technologies. The technologies are applicable to any aircraft with a mission requirement to perform undetected survivable low level penetration.

Responsibility for Quiet Knight will transition from BTI to the Special Operations Command during the Spring of 1993 following the Phase II critical design review.

Funding Plan (\$ Millions)

	FY 1992 & Prior	FY 1993
BTI	40.1	15.1

Current as of February 1, 1993

ULTRA WIDEBAND / HIGH POWER MICROWAVE TECHNOLOGY

INVESTIGATION OF MILITARY UTILITY

This BTI project was initiated in FY 1990 in response to expressions of Congressional interest in the potential military utility of ultra wideband (UWB) high power microwave (HPM) technology. A joint effort was started between BTI and the Services with two major objectives.

- Investigate UWB radar phenomenology, compare the performance of UWB and conventional radar system designs for the same applications, and, if warranted, develop prototype systems to demonstrate advanced capabilities.
- Establish the susceptibility of important classes of U.S. and foreign

electronic systems to UWB/HPM radiation and demonstrate defensive and offensive system prototypes.

Applied to radar systems, UWB short pulse microwaves have the potential for superior performance in applications such as short range air defense and antiship missile defense. Offensively, directed radiation of very high power microwave impulses may have utility as a countermeasure to enemy communications, sensors, and electronically guided weapons. Conversely, U.S. and allied systems may be susceptible to interference from enemy sources of HPM.

TECHNICAL APPROACH

UWB Radar System Concepts

The phenomenology, design techniques, and potential military applications of UWB (impulse or monocycle) technology are less well understood than conventional wideband pulse radar. UWB radar systems have extremely fine range resolution which might be exploited in the detection of stealthy and camouflaged targets. The low frequency content of many UWB wave forms could lead to substantial performance improvements in foliage penetration, target recognition, and land mine detection.

The quantitative evaluation of the military utility of UWB/HPM technology is hampered by the lack of established design

rules, the limited availability of high power impulse generation and transmission components, and an inadequate database of system-oriented laboratory and field experimental results. The BTI approach to correct these deficiencies is through comprehensive technology assessments that include theoretical analyses, phenomenological experiments, component development, and system point design studies. Laboratory and field measurements are attempting to quantify:

- Foliage penetration and sub-surface target detection capabilities
- Antiship missile detection and tracking performance

BTI PROJECT STATUS

- Time domain signal processing and target identification techniques
- Terrain and sea clutter associated with ultrahigh resolution waveforms

Impulse UWB radar designs can be significantly different, and perhaps simpler, than conventional radar designs.

However, impulse UWB radars must process signals at sub-nanosecond intervals to achieve superior performance in clutter and for object identification.

This project includes the design of UWB radar transmitter and receiver components for specific applications.

UWB/HPM Susceptibility Program

Another major thrust of the BTI UWB/HPM project was an assessment of the susceptibility of selected classes of U.S. and foreign electronic systems to UWB/HPM radiation. This task was pursued in association with the DoD High Power Microwave susceptibility program.

If systems were determined to be susceptible, hardening techniques were developed in the laboratory and validated. Effects measurements were conducted on missiles, radars, fuzes, and radio communications.

Radiation Source Development

Field testing and validation requires an adaptable source of UWB/HPM radiation. BTI and the Air Force began joint development of a transportable radiation source testbed. Based on a successful laboratory demonstration of the concept using available components, Kaman Sciences Corporation and Sandia National Laboratory are developing a high power laser activated semiconductor switch (LASS) in conjunction with the Air Force Phillips Laboratory. Performance characteristics of the mobile testbed can be varied over a wide range to examine the effects of UWB/HPM radiation on field systems.

Conventional Vs UWB Radar Concepts

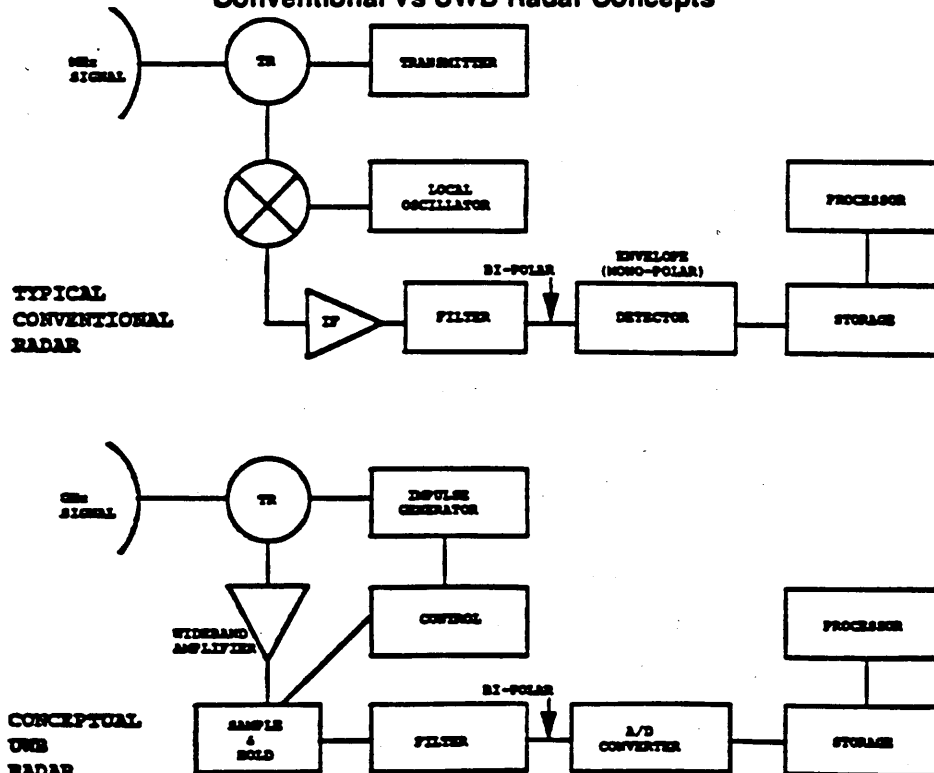

DEVELOPMENT STATUS

Management Approach

The BTI office has provided direction to a tri-service technology development team. ARPA has responsibility for the UWB radar, and the Air Force Phillips Laboratory manages the HPM susceptibility assessment tasks and UWB testbed source development.

Accomplishments and Transition to the Services

Analytical studies and laboratory and field experiments related to design of UWB radar systems have been completed. The results of analyses, experiments, and system point design studies are being provided to DoD and industry development agencies. Measurements and analyses completed in the FY 1992 program confirm that the most attractive applications of UWB technology to radar will exploit the low frequency content and the high range resolution of the wave form, with ground and foliage penetration

in the forefront. With this in view, a program of foliage- and ground-penetrating data collection and system design is being conducted in FY 1993. Among the most severe limitations of UWB radar system technology is the heavy radio frequency interference in the VHF/UHF spectrum. A program is underway to evaluate the effectiveness of advanced signal processing algorithms in mitigating this interference.

Measurements of the effects of HPM radiation on selected missile, radar, communications, and fuze systems have been completed. Reports on the susceptibility of these systems have been provided to the services for use in their HPM programs. BTI support of the susceptibility measurements ended with FY 1992 funds. The fabrication and field tests of the testbed source, started with BTI funds, will be completed in May 1993 with Air Force funds.

UWB/HPM Testbed Source

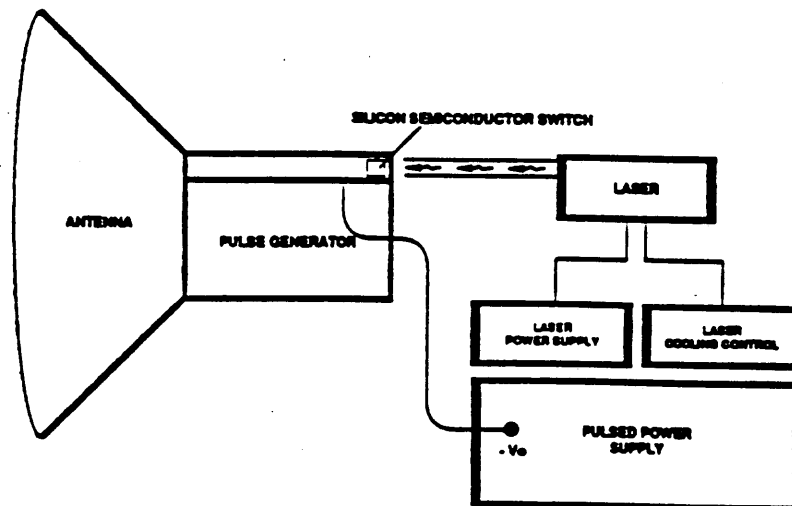

HPM SUSCEPTIBILITY SCHEDULE

Fiscal Years	91	92	93	94	95
Laboratory effects measurements	Communications	▲			
	Missiles	▲			
	Radar	▲			
	Explosives	▲			
Component developments	Advanced semiconductor switch		▲		
	Prototype antennas		▲	▲	
	Testbed source		▲	▲	
Field validation tests				Transfer(ed) to Air Force	

Funding Plan (\$ Millions)

	FY 1992 & Prior	FY 1993	FY 1994
BTI	19.2	7.2	
ARPA			8.5

Current as of January 26, 1993