

UNCLASSIFIED//FOR OFFICIAL USE ONLY



Defense Intelligence Reference Document

Acquisition Threat Support

2 March 2010

ICOD: 1 December 2009

DIA-08-1003-001

Invisibility Cloaking: Theory and Experiments

UNCLASSIFIED//FOR OFFICIAL USE ONLY

Invisibility Cloaking: Theory and Experiments

Prepared by:

**Acquisition Support Division (DWO-3)
Defense Warning Office
Directorate for Analysis
Defense Intelligence Agency**

Author:

**Ulf Leonhardt, PhD Dr. Habil, FRSE
Chair in Theoretical Physics
Royal Society-Wolfson Research Merit Awards Holder
University of St. Andrews**

Administrative Note

COPYRIGHT WARNING: Further dissemination of the photographs in this publication is not authorized.

This product is one in a series of advanced technology reports produced in FY 2009 under the Defense Intelligence Agency, Defense Warning Office's Advanced Aerospace Weapon System Applications (AAWSA) Program. Comments or questions pertaining to this document should be addressed to James T. Lacatski, D.Eng., AAWSA Program Manager, Defense Intelligence Agency, ATTN: CLAR/DWO-3, Bldg 6000, Washington, DC 20340-5100.

Contents

Introduction.....v

Camouflage 1

Transparency 3

Cloaking 5

Metamaterials 9

Optical Metamaterials 11

Fundamental Problem 15

Curved Space 17

Broadband Invisibility 19

Implementation 20

Optical Cloaking 22

Summary..... 23

References 23

Figures

Figure 1. B2 Stealth Bomber 1

Figure 2. Optical Camouflage 2

Figure 3. The Secret Optical Camouflage..... 2

Figure 4. H. G. Wells’s *The Invisible Man*: Invisibility by Transparency..... 3

Figure 5. Complementary Media Invisibility Cloak..... 4

Figure 6. Cloaking Shell..... 5

Figure 7. The Invisible Woman..... 6

Figure 8. Fermat’s Principle 7

Figure 9. An Optical Material Deforms the Coordinates of Space..... 8

Figure 10. Light Waves at Cloaking Device..... 9

Figure 11. Cloaking Device for Microwaves 10

UNCLASSIFIED//FOR OFFICIAL USE ONLY

Figure 12. Lycurgus Cup (British Museum; AD Fourth Century)..... 11

Figure 13. Idea for a Cloaking Device for Visible Light 12

Figure 14. Advances in Metamaterials..... 13

**Figure 15. Demonstration of Negative Refraction With "Bulk" Optical
Metamaterials Made of Nano-Fishnets..... 14**

**Figure 16. Demonstration of Negative Refraction With "Bulk" Optical
Metamaterials Made of Nanowires..... 15**

Figure 17. Fundamental Problem of Transformation-Based Cloaking Devices 16

**Figure 18. Wave Packets are Made by Combining Waves With Different
Frequencies. 17**

Figure 19. Stereographic Projection 18

Figure 20. Non-Euclidean Cloaking Device in Two Dimensions 19

Figure 21. Three-Dimensional Cloaking..... 20

Figure 22. Coordinate Transformation Implemented by a Ground-Plate Cloak. 21

Figure 23. Implementation of the Ground-Plate Cloak 21

Invisibility Cloaking: Theory and Experiments

Introduction

The idea of invisibility has fascinated people for millennia, inspiring many myths, novels, and films. Invisibility cloaking has recently become a subject of science and technology. This paper describes the important current theoretical and experimental developments and tries to project into the future.

Camouflage

Invisibility may be achieved through three principal methods: camouflage, transparency, and cloaking. Many animals and some plants use camouflage to disguise themselves from predators—for example, by assuming the shapes and colors of objects in their surroundings. The military has long used forms of camouflage; a recent military application of camouflage is stealth technology.

Stealth planes have aerodynamically unusual, edgy shapes and are coated with a special material. Both features serve the same purpose: to make the plane "invisible" to radar. How does it work? In radar, electromagnetic microwaves are emitted by a source, and their reflection by an object—an airplane, for example—is detected. From the direction and the time delay of the reflected waves, the direction and distance of the object are inferred. If the object does not reflect the electromagnetic microwaves back to the source, it will not appear on the radar. This is precisely what stealth technology achieves. Owing to the edgy shape of the stealth plane, most of the incident electromagnetic waves are reflected in different directions; the coating of the plane absorbs the rest. In this way, the stealth plane has become completely black in the spectral range of radar. As for radar waves, the sky is black, not blue, and the plane has assumed the color of the background: the stealth plane is camouflaged.

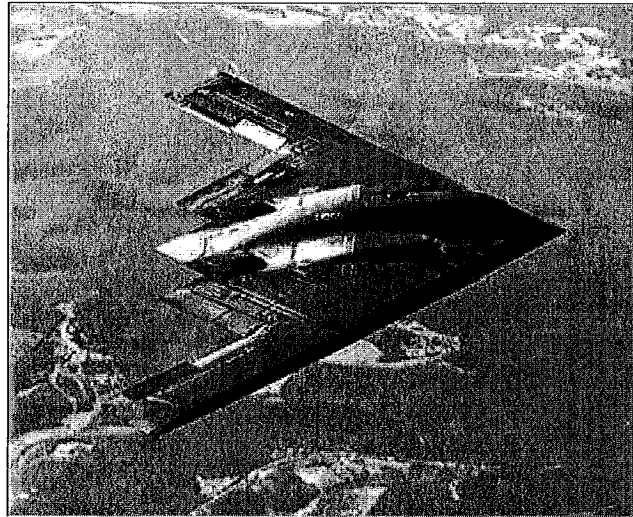

Figure 1. B2 Stealth Bomber

Another recent example of camouflage is optical camouflage, developed by the University of Tokyo's Tachi Laboratory. Figure 2 shows an example of optical camouflage. A camera captures the background scene behind the person. The image is processed and projected onto the person via a semitransparent mirror. The person wears an "invisibility cloak" made of a retroreflective material that reflects light back in the direction whence it came, like cats-eye-reflectors do. As the cloak carries the projected image of the background, the person seems to disappear, but surely the equipment standing around the person is clearly visible. In addition, optical camouflage works only in one direction; seen from the side, the person is visible. Nevertheless, optical camouflage may become a useful tool in some situations where obstacles are in the way of sight—for example in surgery, where the surgeon's hands and instruments may obstruct the view. Figure 3 shows how optical camouflage works.

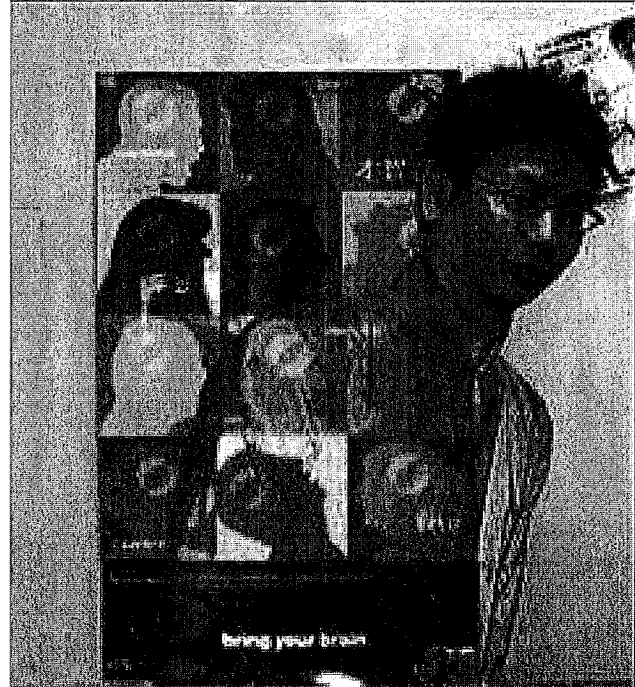

Figure 2. Optical Camouflage (Tachi Laboratory, Tokyo)

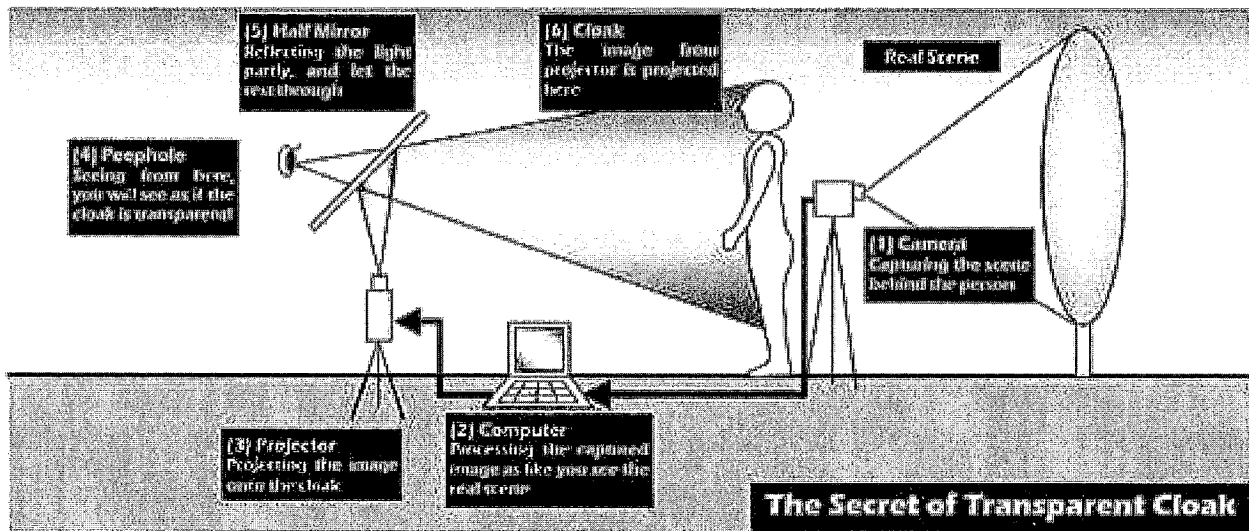

Figure 3. The Secret Optical Camouflage (Tachi Laboratory, Tokyo)

Transparency

H. G. Wells's novel *The Invisible Man* represents another strategy for becoming invisible: transparency. In Wells's novel, the invisible man, a disgruntled college professor, invents a substance that somehow changes the refractive index¹ of his body. Most transparent substances, like glass, air, or water, modify the speed of light, because the atoms or molecules of these substances absorb and re-emit light, which takes time. The delay caused by the atoms and molecules results in a reduced speed of light and hence in a refractive index larger than 1. It is, however, also possible to achieve a refractive index smaller than 1, although only in narrow bands of the spectrum. In these cases, the atoms or molecules advance the wave fronts of light because they are excited such that their electron clouds oscillate ahead of the light. If the refractive index is uniform in a material, light is reflected and refracted at the boundary but otherwise is traveling straight through. On the other hand, if the refractive index varies, light is scattered at the index inhomogeneities and gets lost. Most white substances appear white because of such scattering. Milk, for example, consists of minuscule oily droplets—fat—in water. The refractive index of the droplets differs from water, and hence light is scattered at them; it does not penetrate the substance, and the diffused light appears as white. Now, human bodies are visible, because they absorb light. Most of the absorption is due to the scattering of light in biological tissue, in the cells of which the bodies are made. If the refractive indices of a person's cells could somehow be changed to the refractive index of air, the person would become transparent and disappear from view—like the Invisible Man.

Some animals (for example, some jellyfish) are transparent, but the cells of higher order animals are usually much too complex and diverse for transparency to become a serious option for disguise. Exceptions are the transparent parts of the body, most notably eye lenses, which consist of uniform cells kept in a state between life and death. If this balance is upset, the lenses become opaque as a cataract develops. Transparency is the idea behind some proposed forms of invisibility by technology. For example, in plasmonic covering,¹ a particle should be surrounded by layers made of metals and transparent substances, such as glass. The layers are designed such that they cancel the scattering of light at the particle, hence making both the particle and the layers transparent—that is, invisible. Another proposal² exploits the resonance of the particle with a negative-refractive material that cancels out scattering. In a material with negative refraction, the wave fronts of light appear to move in the opposite

¹ The refractive index is the ratio between the speed of light in vacuum and the speed of light in a material.

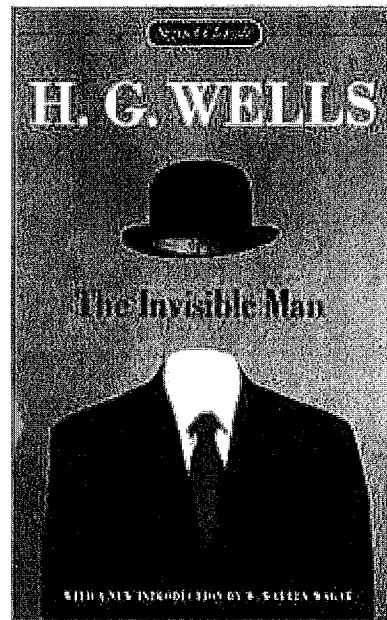

Figure 4. H. G. Wells's *The Invisible Man*: Invisibility by Transparency

direction from the propagation. The clearest and most advanced form of this concept is the complementary media invisibility cloak.³ Here, an optical antioject is placed beside the object one wishes to make disappear. The antioject should be made of a negatively refractive material that exactly compensates the optical appearance of the object. An image is contained in the deformations of light-wave fronts caused by the imaged object. If these deformations are reversed, the image disappears, and the object becomes transparent—that is, invisible. The optical antioject must be tailored to the object and placed precisely at the correct distance—that is, the distance where it is made to cancel the image of the object. The more complex the object is, the more complex the antioject must be for reversing all the scatterings of light. Such cloaking at the distance cannot be instantaneous, as the light scattered by both object and antioject must settle to a stationary state where it becomes synchronized. A stationary light field has only one color. So, in practice, these forms of transparency will work only for small objects and for small parts of the spectrum and not for large objects in many colors.

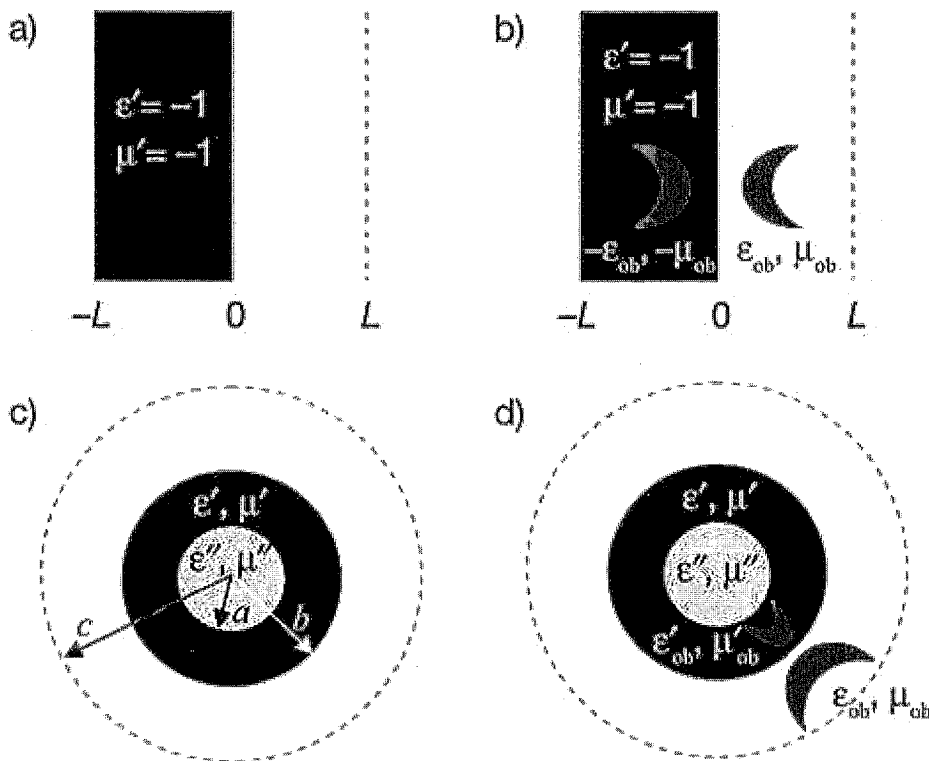

Figure 5. Complementary Media Invisibility Cloak: (a) The slab of empty space x with $0 < x < L$ is optically canceled by a slab of negative-index material in $-L < x < 0$. (b) The same cancellation effect works with an object in $0 < x < L$ if the negative-index slab contains an antioject. (c) A spherical shell $b < r < c$ is optically canceled by a negative-index shell $a < r < b$. If the core $r < a$ is optically equivalent to a sphere of radius c , then this device is invisible. (d) The same as (c), but with an object in the canceled shell $b < r < c$. The object is cloaked: both it and the cloaking sphere are invisible.

Cloaking

Cloaking^{4, 5} is a universal strategy for invisibility that works for objects of arbitrary compositions and shapes within a given size. In cloaking, the hidden object is enclosed by the cloaking device, a transparent shell that guides light around the object as if the light would propagate through empty space. In this way, both the interior of the cloaking device is hidden and the act of hiding is concealed.

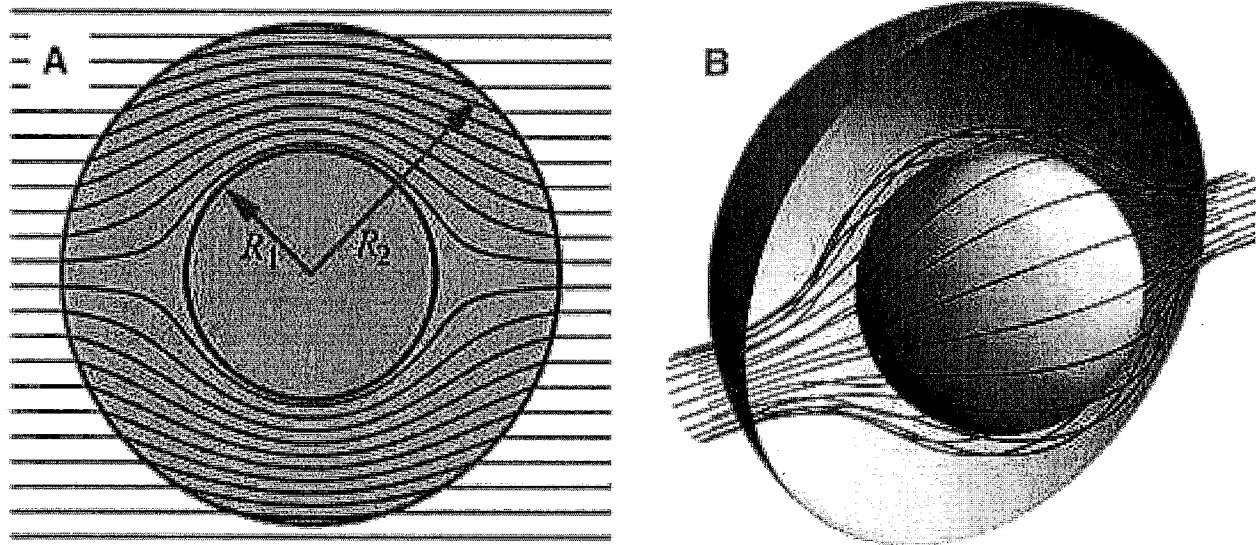

Figure 6. Cloaking Shell⁶

How does one find the right design for such a cloaking device? As the Invisible Man symbolizes transparency as a strategy for invisibility, inspiration for cloaking may come from the Invisible Woman, a cartoon figure from the Fantastic Four. The Invisible Woman is said to create a mysterious force field around her that bends space. Light follows the curved space such that it smoothly flows around the Invisible Woman, like water in a stream flowing around an obstacle. The key idea here is the concept of curved space used for invisibility. The idea that turns the Invisible Woman with her fabled force field from a fictitious character into something close to reality is the insight that no force field is needed, that light-refracting materials like glass or water appear as curved spaces by themselves.

This idea comes from Fermat's principle of the shortest optical path.⁷ Suppose that light travels from A to B. According to Fermat's principle, light follows the path that takes the shortest time. In refractive materials, the speed of light is modified—in most cases reduced—by the refractive index. The time it takes for light to pass through an infinitesimal element of space is proportional to the refractive index. So, if the index varies in an optical material or in the boundaries between materials, the optical measure of path length varies, which is the defining feature of a curved geometry. To provide a simple example, a lens focuses parallel light rays into a point; the parallels meet there, which is the hallmark of a non-Euclidian geometry. So something as familiar as a lens creates something as fantastic as a curved geometry.

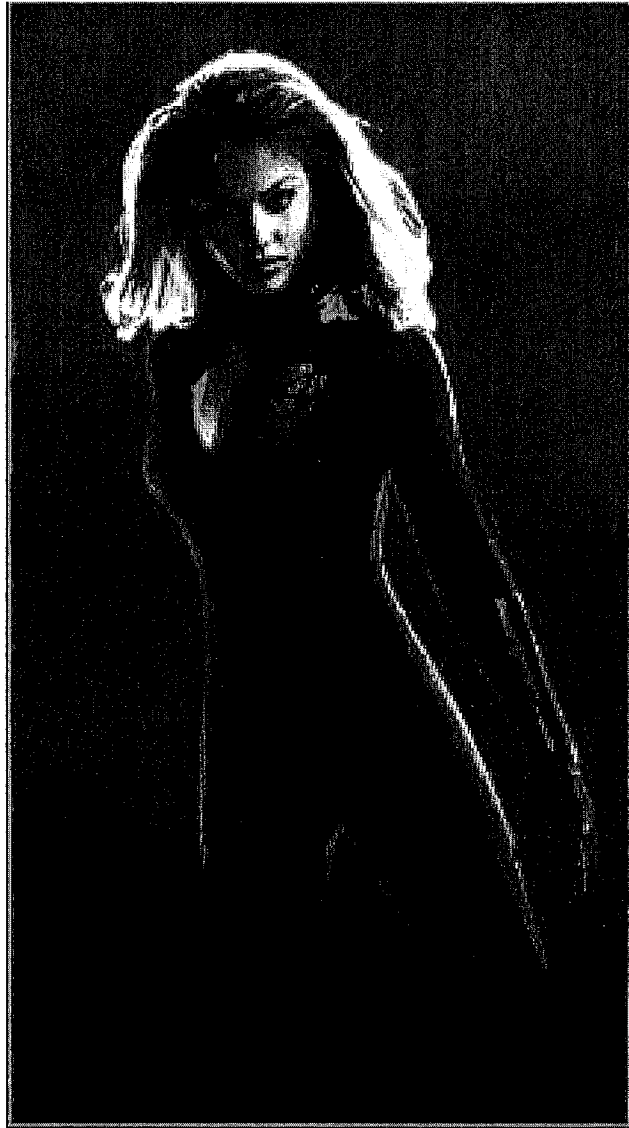

Figure 7. The Invisible Woman. Invisibility by bending light, an inspiration for cloaking.

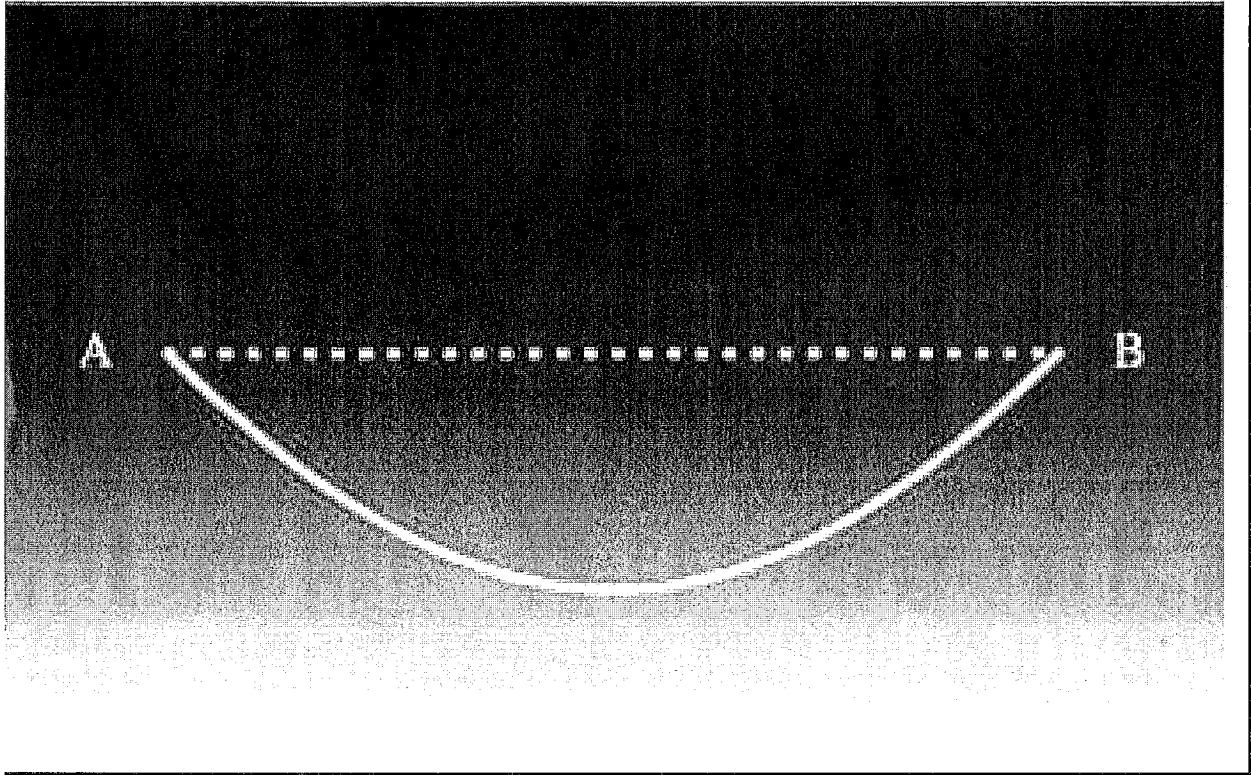

Figure 8. Fermat's Principle. The grey level indicates the refractive index. In traveling from A to B, light follows the path that takes the shortest time, traveling, if possible, through regions of low index.

The bending of light in materials or, equivalently, the change of the spatial geometry by optical materials is the cause of most optical illusions. For instance, the figure used to illustrate Fermat's Principle shows the path of light in a mirage. The air above a hot surface, hot tarmac, or desert sand is hotter than the air farther above. As hot air is thinner than cooler air, the refractive index is lower above the hot surface. Light rays are bent upwards, conjuring up images of water in the distance that, in reality, are images of the sky. Such optical geometries may also be employed for creating the ultimate illusion: invisibility. Imagine an optical material changing the geometry of space, as shown in Figure 9 below.

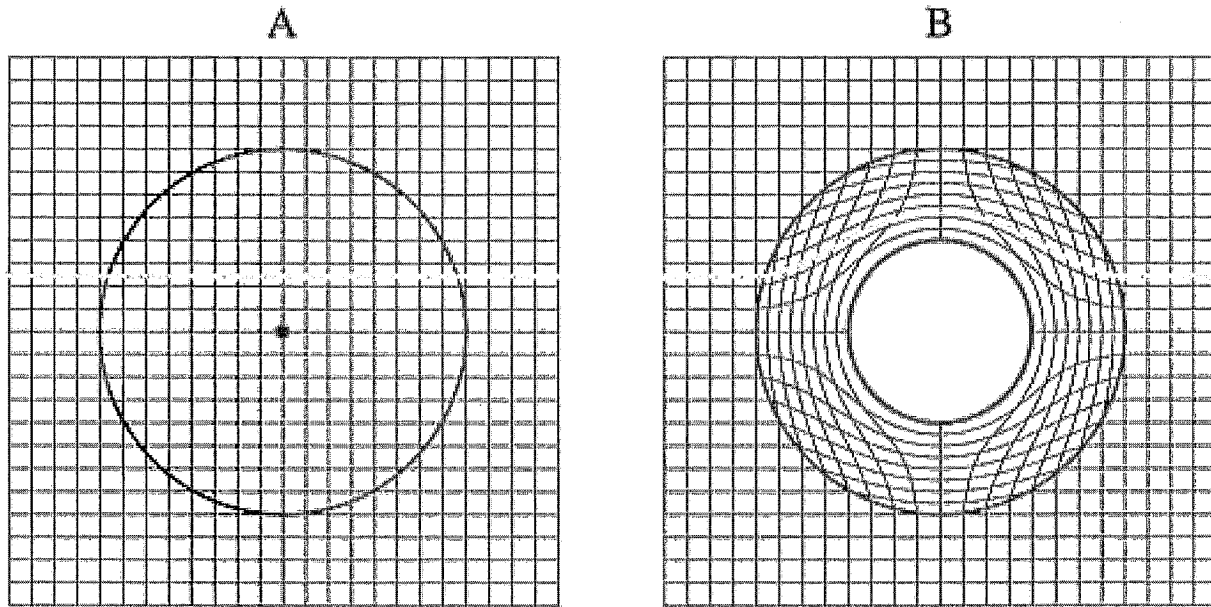

Figure 9. An Optical Material Deforms the Coordinates of Space. A: virtual space, B: real space.

The material acts like a transformation of space. In the device, each point in real space is put to a new location in a virtual space (outside of the device, space remains the same). The device creates the illusion that light propagates along straight lines through the virtual space, whereas in reality it is bent. Suppose the device encloses a hollow region that is not part of the virtual space or, to be more precise, a region with a surface that, in virtual space, has become a single point. The red circle in Figure 9B is reduced to the red dot in Figure 9A. As the hollow region is not part of the virtual space where light propagates, everything inside it has become invisible. As the coordinates of virtual space smoothly go over into the coordinates of real space at the outer surface of the device, light rays are not distorted. Any object inside the cloaking device is hidden, and so is the act of hiding itself. Moreover, the cloaking device not only would bend light rays but would modify the entire structure of light waves in such a way that detecting the hidden object is impossible. Light waves would advance around the hidden core of the device, engulfing it, as Figure 10 shows.⁸

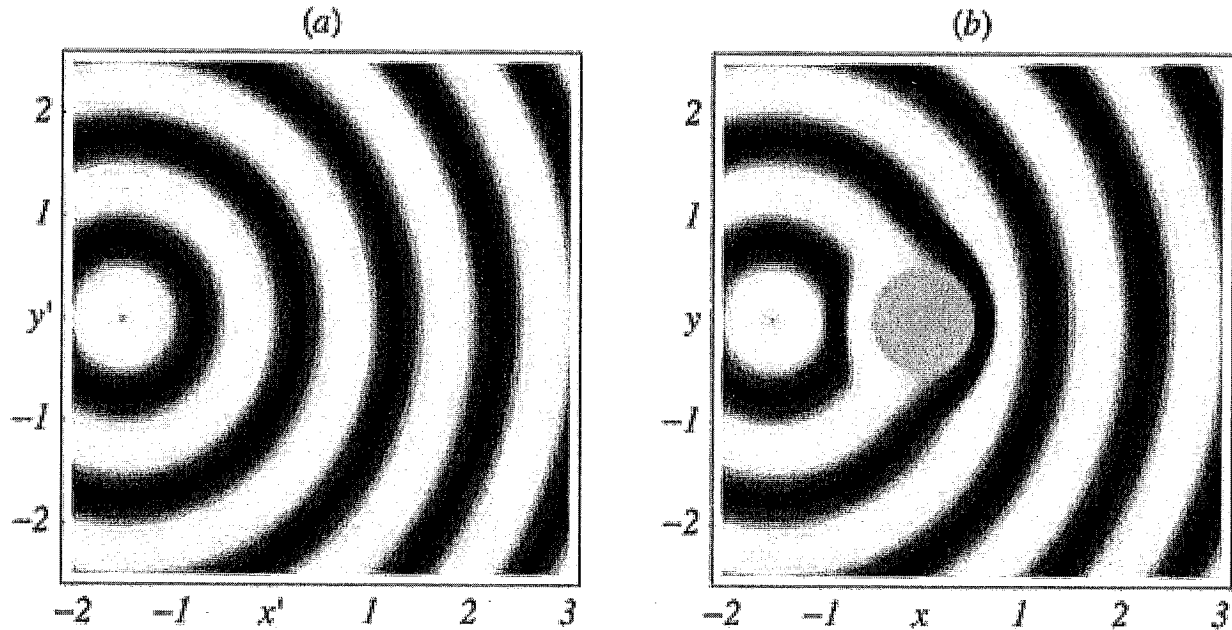

Figure 10. Light Waves at Cloaking Device. Wave propagation in (a) virtual space and (b) real space.

This idea of cloaking by coordinate transformations was put forward by two independent groups. Their theories appeared in *Science Express* on 25 May 2006 and were published back to back in *Science* magazine later on. The first paper⁹ only considered isotropic materials, optical materials where the speed of light at each point is the same in each direction but may vary from point to point. Most natural optical materials, except for some crystals and all liquid crystals, are isotropic. In isotropic materials, invisibility is perfect only for light rays, but the cloaking device may cause dislocations of light waves. In addition to the optical implementation of coordinate transformations, some other tricks are required. The second paper¹⁰ considered anisotropic materials for cloaking or other manipulations of electromagnetic waves. Here, perfect invisibility is possible in principle (but not in practice, as is discussed later). In October 2006, the first cloaking device was demonstrated,¹¹ for microwaves. *Science* magazine regarded cloaking as one of the top 10 science breakthroughs of the year (it was top in physics and engineering). *Scientific American* listed the inventors of cloaking devices—Sir John Pendry, David Smith, David Schurig, and Ulf Leonhardt—among the top 50 policy, business, and research leaders of the year. The first paper¹² on cloaking had initially been rejected by most major science and physics journals before it finally appeared in *Science*, but since 2006, cloaking has become a mainstream subject on which about a thousand papers have been published so far.

Metamaterials

The first prototype¹³ of a cloaking device was designed to operate in the microwave region of the electromagnetic spectrum, for a wavelength of about 3 cm. The device consists of 10 rings of flexible circuit board. The copper of the circuit board has been etched away, apart from characteristic structures of about 3-mm size, so-called splitting resonators.

The split-ring resonators are electromagnetic circuits; they respond to the electromagnetic field of microwave radiation. Their response depends on their shapes. For example, in the cloaking device shown in Figure 11, the double stripes in the middle of the split-ring resonators vary from ring to ring. As these stripes form an electric capacitor, the capacitance of the resonators also varies. The colored curves show how the electromagnetic functions change over the distance from the center of the cloaking device as a result of the varied capacitance. As they are always positive, negative refraction is not required for cloaking. At the inner ring, the red curve reaches zero, defining the boundary of the cloaking device. The rings with their split-ring structures are designed to perform an approximation of the

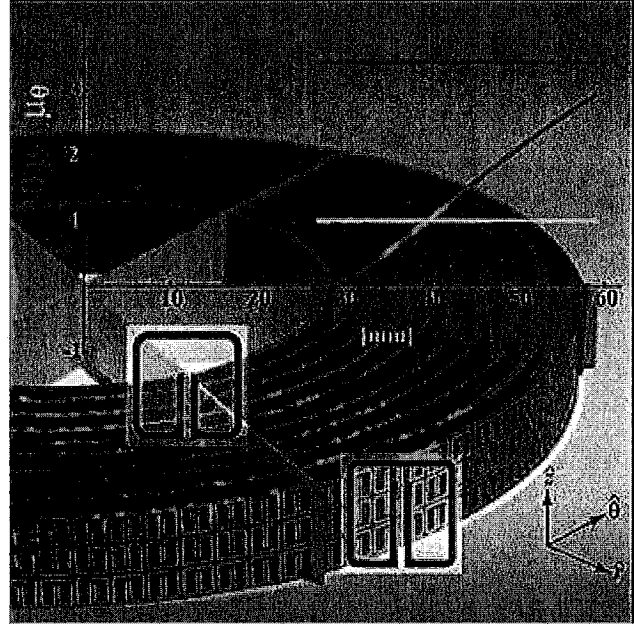

Figure 11. Cloaking Device for Microwaves¹⁴

coordinate transformation shown and explained in the previous section. How is this possible? The split-ring resonators act like the atoms or molecules of a normal optical or electromagnetic material: they absorb electromagnetic waves and re-emit them with a phase delay or advance that depends on their electromagnetic response. Like atoms or molecules, they are much smaller than the electromagnetic wavelength—3-mm cell size versus 3-cm wavelength in the case of the microwave cloaking device¹⁵—such that the waves cannot resolve them individually but, rather, react to them as if they were a bulk material with electromagnetic properties that may differ from point to point. Unlike atoms or molecules, the electromagnetic response of each split-ring resonator is tailor-made because it depends on the shape of the resonator that can be easily modified. For example, in the case of the microwave-cloaking device,¹⁶ the electromagnetic response depends on the capacitance that is varied by changing the length of the double stripes in the resonators. An unstructured circuit board reacts completely differently to the microwave radiation: it would simply reflect it like the mesh in the window of a microwave oven. A material with electromagnetic or optical properties that depends on structures much smaller than the wavelength is called a metamaterial.

Metamaterials per se are nothing new; the ancient Romans invented the first optical metamaterial: ruby glass. The Romans probably did not know it, but their recipe for ruby glass contained one crucial ingredient:¹⁷ tiny gold droplets, typically 5–60 nanometers (nm) in size. These gold particles color the glass in an extraordinary way, as demonstrated by the exquisite Lycurgus Cup shown in Figure 12. In daylight, the cup appears a greenish color, but illuminate it from the inside, and it glows ruby. The gold particles act like the split-ring resonators of the microwave-cloaking device,¹⁸ but here on light, not on microwave radiation. Light consists of electromagnetic waves as well, but with significantly smaller wavelengths of around 500 nm. The gold particles are thus much smaller than the wavelength of light, and they turn out to be resonators as well: in them, electric currents flow in a way that is dictated by their shapes and sizes. When the light wave hits the resonance of the gold particle, most of its energy is

converted into the electromagnetic oscillation of the gold particle in much the same way a tuning fork responds to sound of the right frequency.

However, the electromagnetic oscillation is damped out by the electric resistance in the metal, and its energy is absorbed and ultimately turned into heat. The color of light corresponds to the frequency or wavelength. If one of the frequencies is absorbed, the corresponding color is missing in the spectrum. For the gold particles in the Lycurgus Cup, this color is green; a spectrum with green missing appears red, which produces the cup's exquisite color. (Light is also scattered in the material, and this scattering is enhanced near the green of the resonance; hence the greenish color of the cup seen in daylight.)



Figure 12. Lycurgus Cup (British Museum; fourth century AD). This Roman cup is made of ruby glass. When viewed in reflected light—for example, in daylight—it appears green. However, when a light is shone into the cup and transmitted through the glass, it appears red. The cup illustrates the myth of King Lycurgus. He is seen being dragged into the underworld by the Greek nymph Ambrosia, who is disguised as a vine.

What is new about metamaterials is the degree of control on their structures achieved by applying modern technology and the level of theoretical

understanding of their workings. The Romans most probably never understood why ruby glass is neither golden like gold nor transparent like glass, its ingredients, but ruby. They did not know that light is an electromagnetic wave, nor did they know the basic laws of electromagnetism. And they would not have had the technological tools to use this knowledge in the design of novel optical metamaterials.

Optical Metamaterials

As light is simply an electromagnetic wave with shorter wavelengths than microwave radiation, one could imagine an optical cloaking device as the microwave cloak but with much smaller cells, fitted to the smaller wavelength. However, this simple idea is too simple, for two different reasons. One is that metals like the copper of the circuit board or the gold of ruby glass are more electrically resistant to currents oscillating with the frequency of visible light than to currents in the microwave range of the spectrum. Second, and more important, the cells of a metamaterial also emit electromagnetic radiation in an incoherent way, not just as a coherent response to the incoming electromagnetic wave, similar to the spontaneous emission of light by atoms and molecules. The spontaneous emission is significantly stronger in the optical range of the spectrum. In short, metamaterials do not scale; they must be designed differently for visible light, and the loss of light by absorption and incoherent scattering usually is greater for visible light than for microwaves. Figure 13 below illustrates the idea¹⁹ for an optical cloaking metamaterial. Instead of split-ring resonators, nano-scale metal wires are embedded in a transparent host material, for example glass. The wires replace the split-ring resonators on the circuit board of the microwave-cloaking device. They act similarly to the gold particles embedded in ruby glass; their optical properties

depend on their lengths and on their arrangement, which, in principle, can be tailor-made and controlled using the tools of modern nanotechnology. The thin wires will have lower electric losses than split-ring resonators, and their radiation losses by the equivalent of spontaneous emission are reduced as well. Such optical cloaking devices do not yet exist, but one can gauge the progress in the required technology by considering the progress in negatively refracting optical materials.

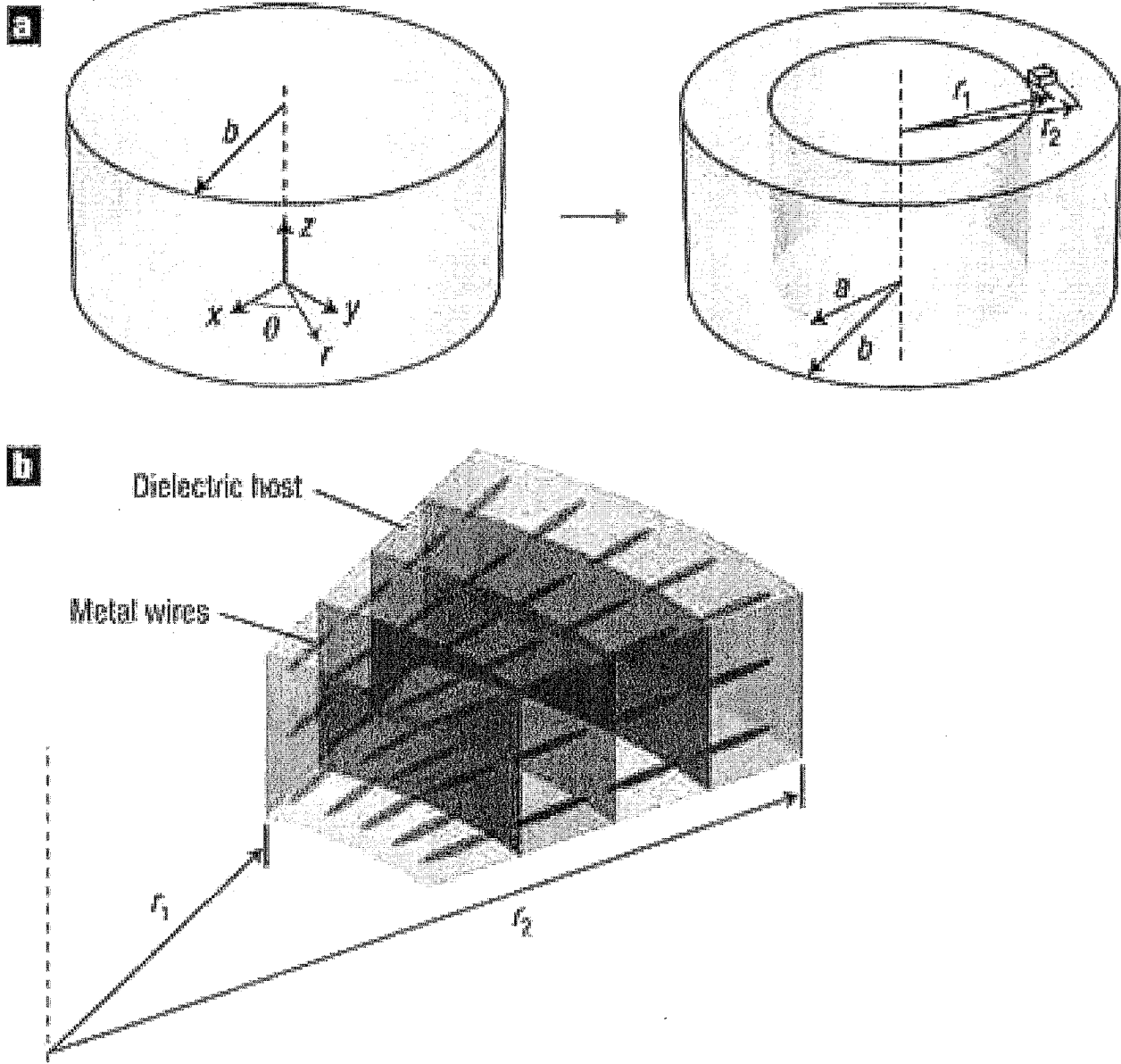

Figure 13. Idea for a Cloaking Device for Visible Light. Metal nanowires replace the split-ring resonators of the microwave cloaking device. Coordinate transformation and structure of the optical cloak. a: The coordinate transformation that compresses a cylindrical region $r < b$ into a concentric cylindrical shell $a < r < b$. There is no variation along the vertical direction. The radii r_1 and r_2 define the internal and external radius of a fraction of the cylindrical cloak. b: A small fraction of the cylindrical cloak. The wires are all perpendicular to the cylinder's inner and outer interfaces, but their spatial positions do not have to be periodic and can be random.²⁰

Figure 14 below²¹ illustrates the route toward achieving negative refraction in the visible range of the spectrum. Losses typically are a greater problem for negatively

refractive materials than for the metamaterials of cloaking devices. So the graph indicates the possible progress toward optical cloaking.

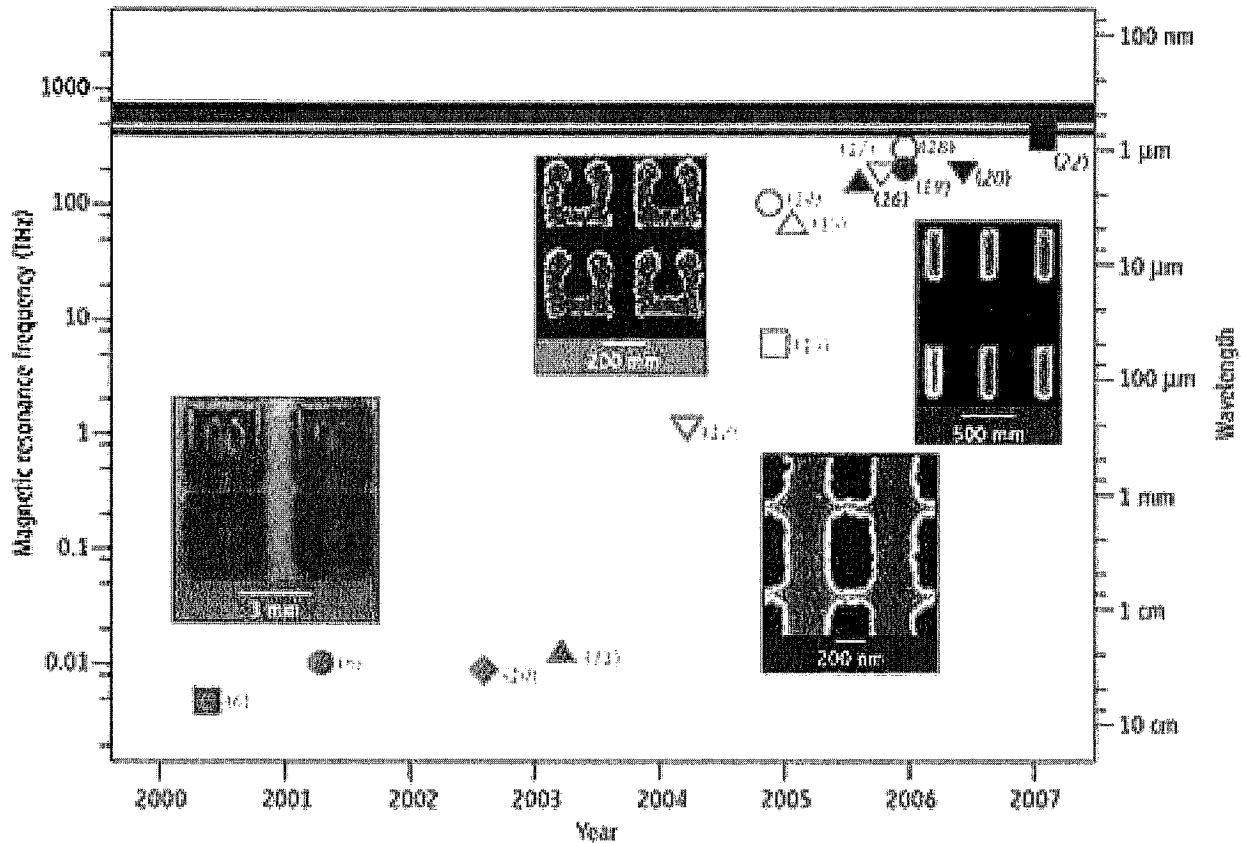

Figure 14. Advances in Metamaterials. The solid symbols denote materials with negative refraction; the open symbols denote optical materials with negative magnetic response. Orange: data from structures based on the double split-ring resonator (SRR); green: data from U-shaped SRRs; blue: data from pairs of metallic nanorods; red: data from the "fishnet" structure.²²

On the other hand, cloaking devices require bulk metamaterials with varying cell structures. The first moderately bulk negatively refracting materials^{23, 24} were made only recently.

The most severe practical problem of the currently discussed cloaking devices is not the technology for manufacturing and structuring the required metamaterials but a problem at the core of their principal design.²⁵

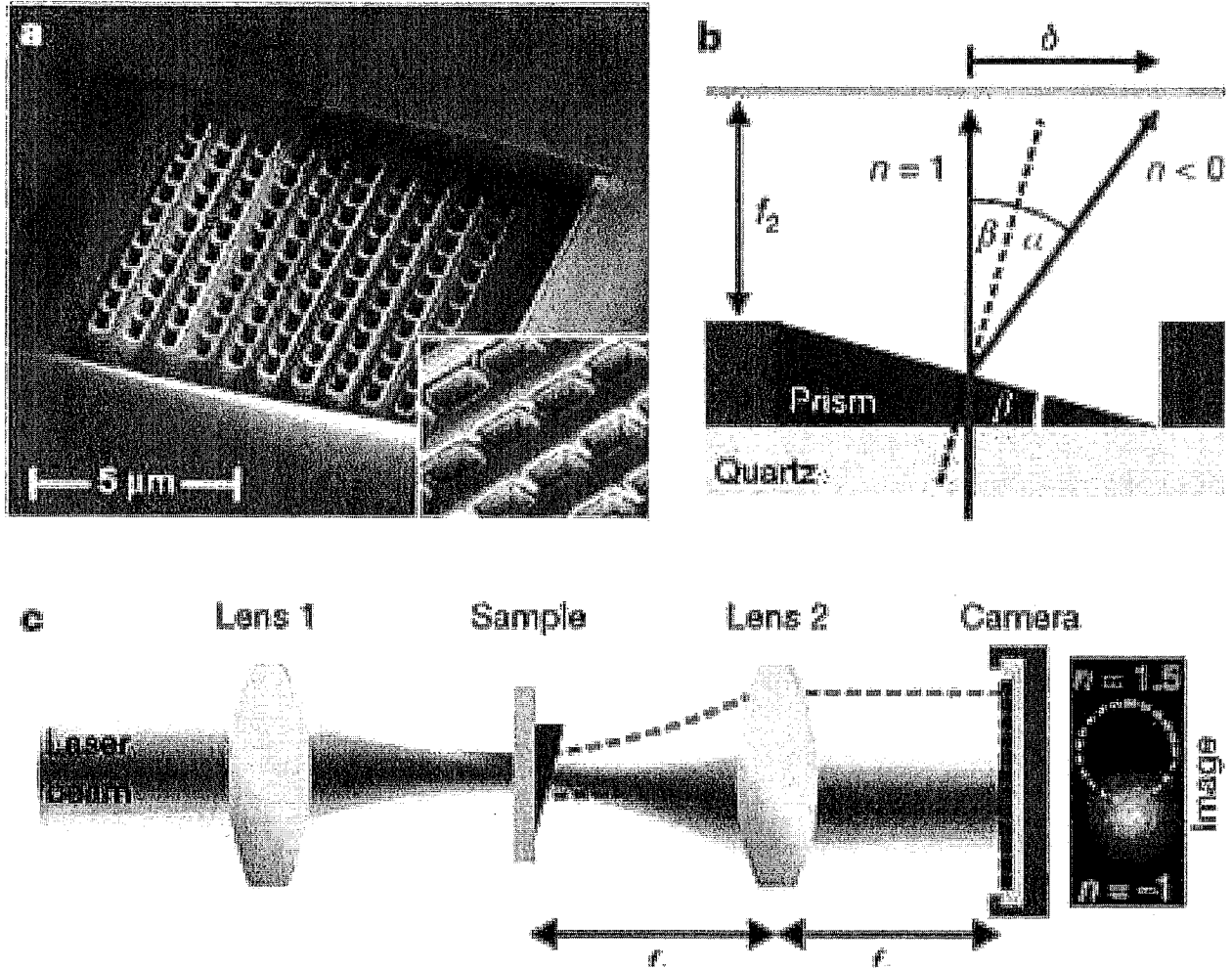

Figure 15. Demonstration of Negative Refraction With "Bulk" Optical Metamaterials Made of Nano-Fishnets²⁶

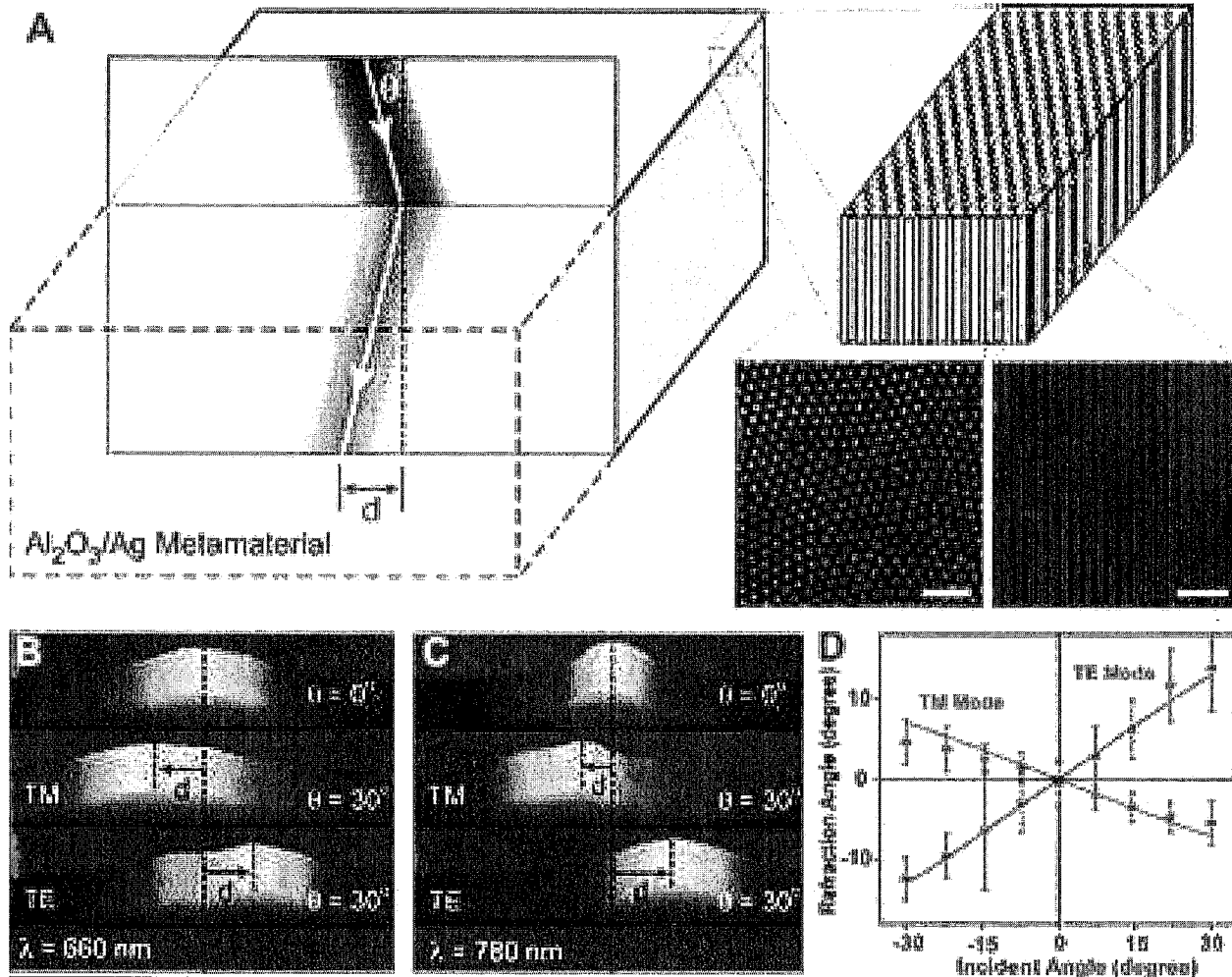

Figure 16. Demonstration of Negative Refraction With "Bulk" Optical Metamaterials Made of Nanowires²⁷

Fundamental Problem

The demonstrated microwave-cloaking device only works correctly for microwave radiation of a specific frequency (wavelength), and the proposed optical cloaking device would also work for just one frequency; that is, for only one color. Light of different colors would be severely distorted. So, to see things disappear in a cloaking device, one should wear tinted glasses of the required color, which of course completely defeats the purpose. This design flaw is inevitable,²⁸ no matter how much progress is made in the technology of metamaterials, for the following reason: the device is designed such that light waves traveling around the object enclosed by the cloaking device are completely indistinguishable from light waves propagating through empty space. This is achieved by implementing the coordinate transformation shown below in Figure 17.²⁹

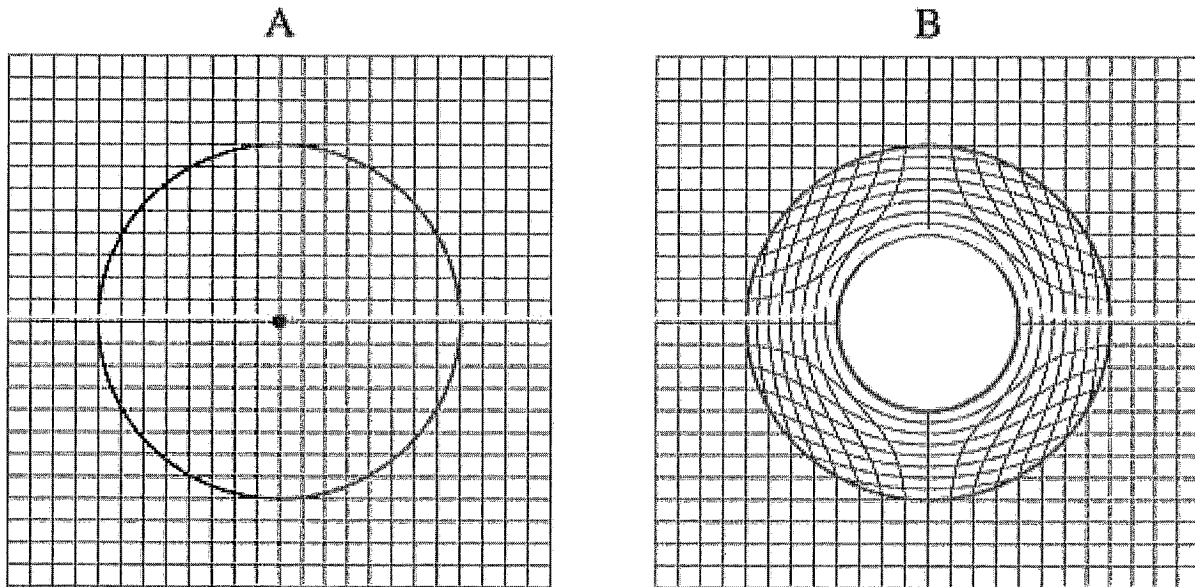

Figure 17. Fundamental Problem of Transformation-Based Cloaking Devices³⁰

The device creates the illusion of the empty virtual space A where light travels along straight lines, whereas in reality light rays are curved by the coordinate transformation from virtual space to real space B. If the light waves are indistinguishable from light propagating through empty space, the speed of light in the cloaking device must be larger than the speed of light in the surrounding material—air, for instance—to make up for the longer path on the detour through the cloak. To make matters worse, the speed of light must be infinitely large at the inner lining of the invisibility cloak. To understand this, consider a light ray that just straddles the red point in the virtual space shown in A. In real space, B, this point is enlarged to a finite volume that contains the hidden core of the cloaking device. Now, if for light propagation virtual space and real space are indistinguishable, the light ray should pass the extended path along the inner lining in precisely the time it takes to pass a single point, zero time. Consequently, the speed of light must approach infinity near the core of the cloaking device. The following argument shows that this is possible in principle, but also that such devices would be completely useless as a cloaking device in practice.

In wave propagation, one distinguishes between the phase velocity and the group velocity. The phase velocity is the velocity at which the phase fronts of waves appear to move. For light, the wave fronts are the features of oscillations across space and time; by themselves they do not transport energy or information. On the other hand, the phase fronts are orthogonal to the paths of light rays; if they are tilted, rays are refracted. Therefore, the refraction of light, the bending of light rays, is controlled by the phase velocity. The refractive index that enters Fermat's principle of the shortest optical path is the phase index, the ratio between the speed of light in vacuum and the phase velocity in the material. The group velocity is the speed at which wave packets, pulses, and most information travels; it is the velocity of a wave group. Such a group consists of a range of single-frequency waves that, by their interference, establish the group, the wave packet, as Figure 18 below shows.

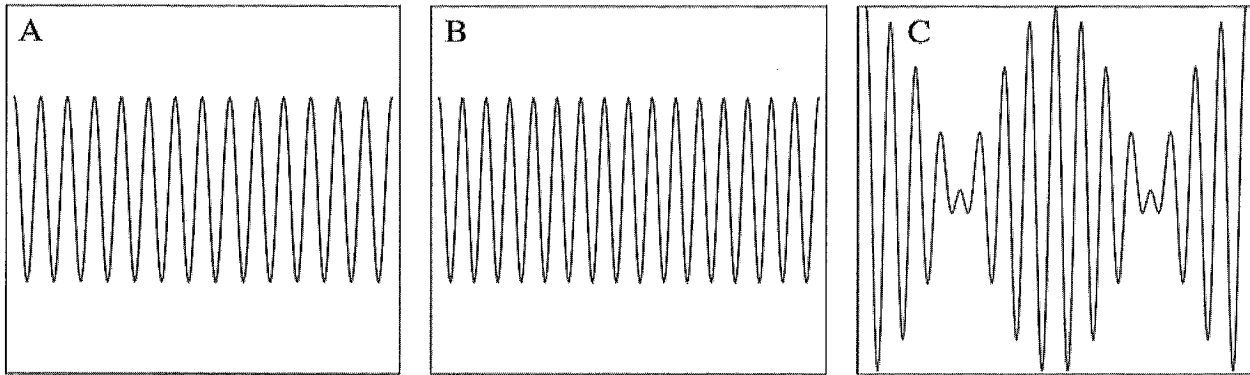

Figure 18. Wave Packets are Made by Combining Waves With Different Frequencies. The picture shows the simplest example: two waves (A and B) that add up to the wave packet (C).

Suppose that the phase velocity varies for different frequencies, what is called dispersion. In this case, the wave group made by the constructive interference of the single-frequency waves moves at a different speed than the phase velocity: group and phase velocities differ. So, in dispersive materials, the phase velocity may approach infinity without violating the principles of relativity, but only for a single frequency, because otherwise the group velocity would tend to infinity as well. The cloaking of electromagnetic waves of fixed frequency is possible, as the successful demonstration of the microwave-cloaking device has confirmed, but the cloaking of wave packets carrying information is impossible. It turns out³¹ that the group velocity actually tends to zero at the inner lining of such cloaking devices; wave packets would get stuck there instead of traveling around. Turning invisibility from a tantalizing idea into a practical device requires a new paradigm.³²

Curved Space

Light rays are curved in materials with varying refractive index. In conventional cloaking devices, the rays are curved because the material performs a transformation to curved coordinates. However, the curvature of a space does not depend on coordinates; curved coordinates create the illusion of curvature, but the space they describe is still flat. A flat space obeys the axioms of Euclidean geometry, in particular the parallel axiom: through each point outside of straight line goes exactly one parallel line; parallels never meet. The light rays focused by a lens clearly violate the parallel axiom, because parallel light rays meet at the focus of the lens. Optical materials establish non-Euclidean geometries in general; the Euclidean geometries of cloaking devices are rather the exceptions. The advantage of Euclidean spaces is that one can easily visualize them; curved space is difficult to comprehend, in particular three-dimensional curved space. However, two-dimensional curved spaces can be visualized as surfaces of three-dimensional curved objects. These surfaces are the virtual spaces that are implemented, by the optical material, in physical space.

The simplest example is the sphere. On the surface of the sphere, the equivalent of straight lines, the geodesic lines, are the great circles. The great circles originating from one point meet again at the antipodal points, which shows that the surface of the sphere establishes a non-Euclidean geometry. To implement this geometry in the two-

dimensional plane, one can use the stereographic projection, the central ingredient of the Mercator projection in cartography that is used to map the surface of a round object, the Earth, onto a flat sheet of paper.

A line drawn from the North Pole of the sphere through a point on the surface intersects the equatorial plane at one point. This point is the stereographic projection of the point on the sphere. Figure 19 shows that the stereographic projection of a circle on the sphere is a circle on the plane with a different radius. The stereographic projection distorts the measure of space, but the distortion around any given point is the same in all directions, because otherwise circles would be deformed. Therefore, an optical material that implements the geometry of the sphere via the stereographic projection must be isotropic. One can read off the required refractive index from the drawing as follows: in virtual space, on the sphere, light propagates at the speed of light in vacuum from a point to its infinitesimally close neighbor; in physical space the distance between the two infinitesimal neighbors is modified—the speed of light is changed by the refractive index that is given by the ratio between infinitesimal distances in virtual space and the corresponding distances in physical space. For the stereographic projection, the refractive index is smaller than 1 for points on the northern hemisphere and larger than 1 on the southern hemisphere. This device is known as Maxwell's fish-eye lens.³³ In this lens, light follows the great circles, light goes around in circles, and light rays meet at antipodal points; the fish-eye makes a perfect lens (although a fairly near-sighted one). It is possible to extend these ideas to three-dimensional curved spaces. For example, the surface of the four-dimensional sphere is a three-dimensional curved space, and the device implementing this hyperspace object is just a three-dimensional fish-eye. Hyperspace is not out of this world; it can be built, and it turns out to be practically useful for invisibility.³⁴

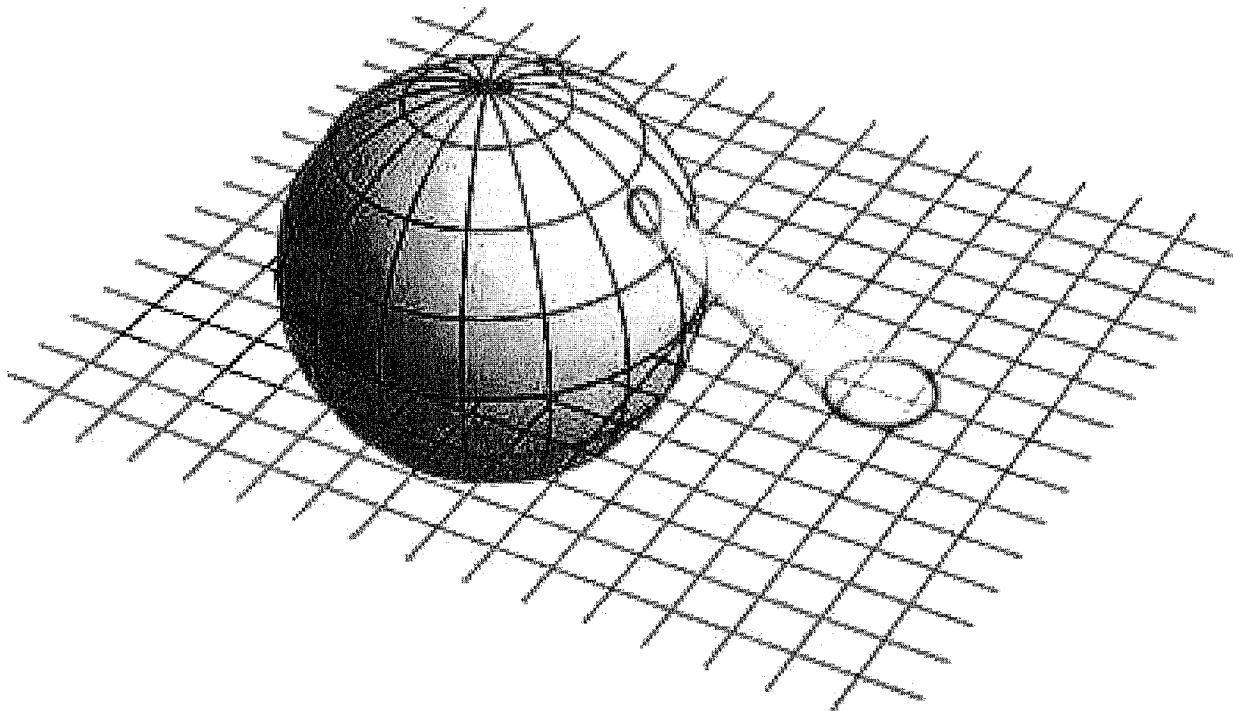

Figure 19. Stereographic Projection

Broadband Invisibility

To understand why non-Euclidean geometry comes to the rescue of invisibility, consider the following two-dimensional example.³⁵ Imagine a virtual space made of a flat space, a sheet of paper, and a curved space, the surface of a sphere. The two spaces touch at one line. Consider the fate of light rays in this two-dimensional virtual world. Light rays would either pass the sphere or enter, through the connecting line, the surface of the sphere, whereupon, after one loop, they would continue in the same direction as they entered, as if the tour on the sphere had never happened. The sphere is invisible; it shows only as a time delay of the light ray. Although the sphere is invisible, it does not make something else invisible yet. However, this is easily arranged. Imagine a mirror around the equator of the sphere. The ray bounces off at the mirror, but, after another bounce, is back on track. A mirror in this curved space reflects light back to itself! The mirror creates the illusion that the light performs a full great circle, whereas in reality it stays on one hemisphere. The other hemisphere is hidden. Alternatively, some lines on the sphere are never crossed by light rays. Such lines can be opened like an eye; the space they enclose is hidden from sight.

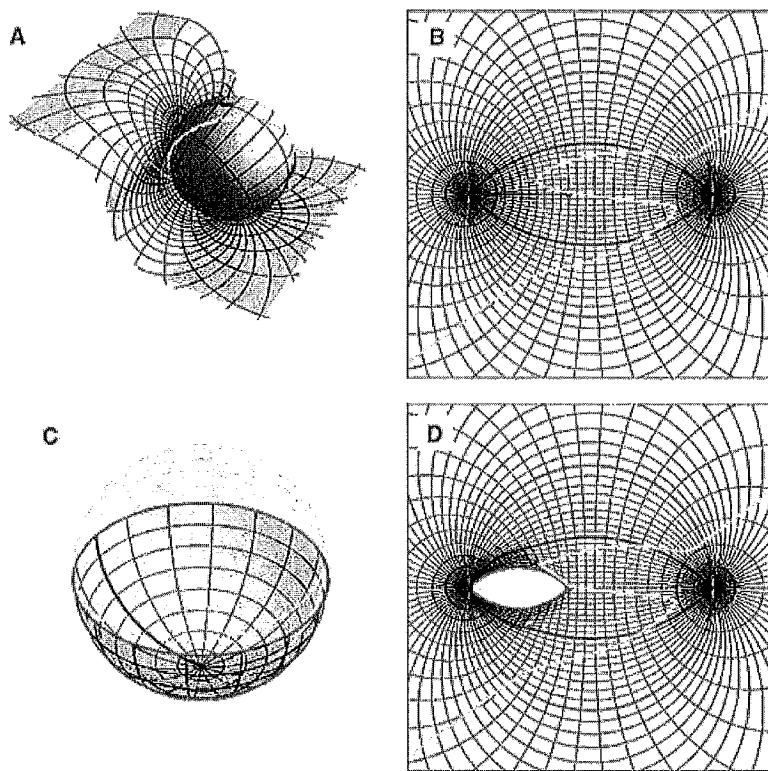

Figure 20. Non-Euclidean Cloaking Device in Two Dimensions. The device creates the illusion shown in A: light propagates through a virtual space that consists of a plane and the surface of a sphere, a curved space, which touch along a line. Some incident light rays venture from the plane to the sphere; they return after one loop and continue in the same direction. Note that the rays never cross the red zigzag line on the sphere. Plane and sphere carry a coordinate grid that is mapped onto physical space B. The magenta circle defines the boundary of the device. Its interior has been expanded to make space for the grid of the sphere. In particular, the line where plane and sphere touch has been opened like an eye (thick black lines) to include the sphere. This is not a cloaking device yet, but one could place a mirror around the equator of the virtual sphere C, making the northern

hemisphere invisible and creating the same illusion as shown in A. Alternatively (D), one could expand the red line that light never crosses to create a hidden space.

Why are such curved optical spaces of any practical advantage? They seem more complicated, but the distortion of space in such spaces is always finite, never infinite as in the conventional Euclidean cloaking devices. As the spatial distortions directly correspond to the required refractive indices, the required optical properties are never infinite, and hence such devices can, in principle, operate in a broad band of the spectrum. Curved space is more practical than flat space, although the theory is more complicated. These ideas can be extended from the two-dimensional toy model to the three-dimensional world, but they can no longer be visualized. Figure 21 below shows some ray trajectories in three-dimensional non-Euclidean cloaking devices.

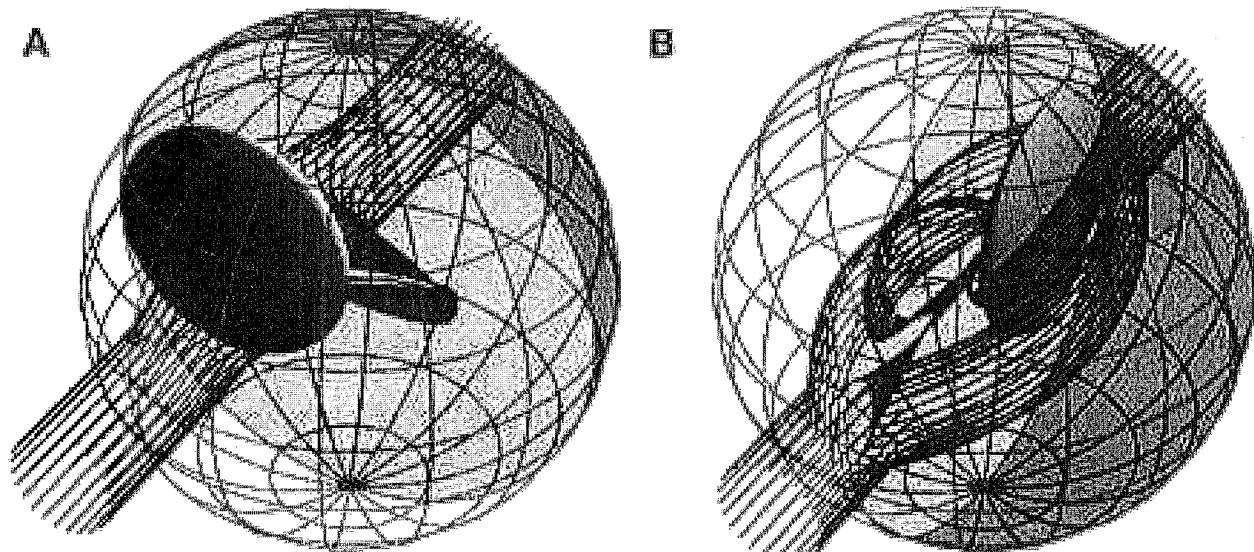

Figure 21. Three-Dimensional Cloaking. One can extrapolate the ideas illustrated in the previous figure to three-dimensional space, replacing the plane by flat space and the sphere by a hypersphere. The lentic-shaped object indicates the hidden interior of the device; the partly shaded grid, the boundary of the invisibility device. For better contrast, light rays are shown in red. A: Rays are bent around the invisible region. B: In three dimensions, some rays turn out to perform two loops in hyperspace that appear in physical space as light wrapped around the invisible interior.

Such non-Euclidean cloaking devices are imperfect because they delay the light traveling through the cloak. With sensitive timing or wave-front sensing one could, in principle, detect the presence of the cloaking device. Perfect cloaking is impossible, but as long as time delays and wave-front dislocations are of no concern, invisibility could become reality.

Implementation

Non-Euclidean cloaking devices do not have an obvious symmetry like the Euclidean microwave-cloaking device.³⁶ They require materials with an electromagnetic response that varies from cell to cell and is anisotropic. Most probably, such cloaking structures can be made for microwaves. A precursor of the necessary technology is the recently demonstrated ground-plate cloak.³⁷ This device implements the coordinate transformation shown below (that already appeared in the first paper on cloaking by

coordinate transformations). This is not a cloaking device: it compresses an extended region of space to a reflecting plate; the interior is hidden behind the plate, but the plate is clearly visible. Such a device conceals the extension and shape of the hidden region but not the fact of hiding itself.

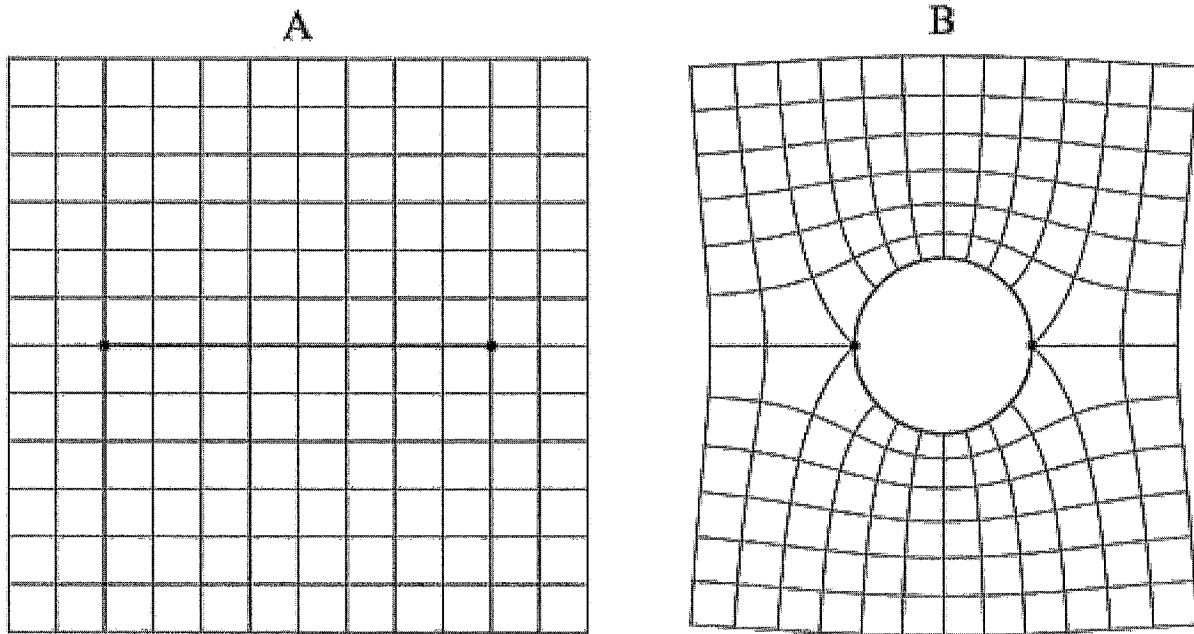

Figure 22. Coordinate Transformation Implemented by a Ground-Plate Cloak

In order to implement the ground-plate cloak, thousands of cells with split-ring resonators with individual, tailor-made electromagnetic properties were designed, as Figure 23 shows.

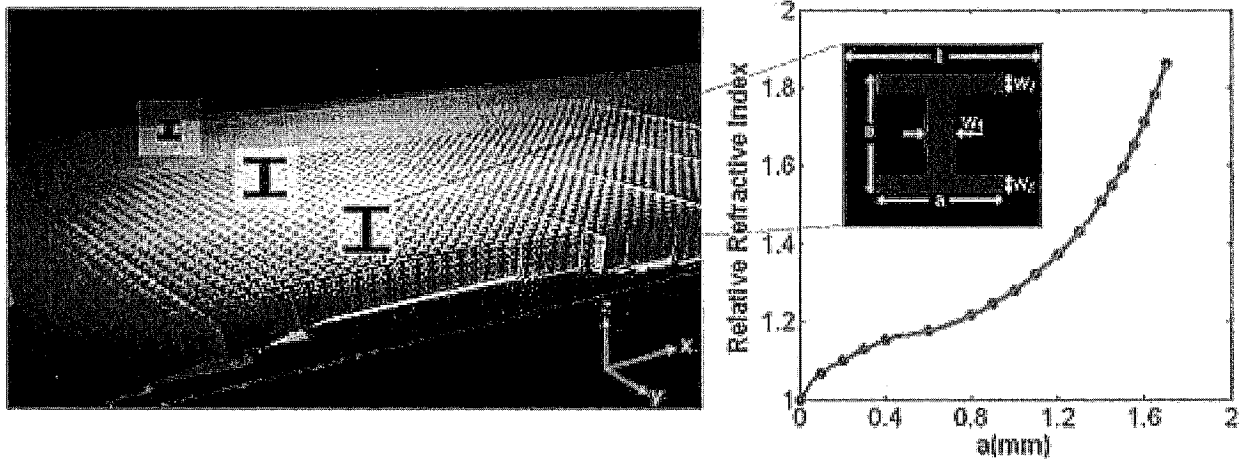

Figure 23. Implementation of the Ground-Plate Cloak³⁸

Optical Cloaking

Cloaking in the optical range of the spectrum poses several challenges. The present design of non-Euclidean cloaking devices still requires materials where, in some parts of the device, the speed of light is larger than in the environment of the device, which, in practice, means larger than the speed of light in vacuum. Most probably, this problem can be circumvented by inventing new designs and new geometrical forms of suitable curved spaces, because there is no mathematical reason why non-Euclidean cloaking should be limited in this way. However, solving this problem takes imagination and mathematical creativity; it cannot be planned by a clear roadmap, but it can be encouraged and stimulated. It could take 1 or 2 years or a much longer time until such designs are invented; truly imaginative research is unpredictable. This research takes a specific mindset, clear mathematical thinking combined with playfulness and physical intuition, a stimulating environment, and freedom. The greatest challenge for turning invisibility from an idea into a workable device is not technology but imagination. The only way to solve this problem is to follow the Solomonic advice to invest in the right people.

The technology for cloaking will depend on the design of such advanced cloaking devices. Probably they will require highly anisotropic materials, but perhaps liquid crystals could be sufficient. Maybe metamaterials are not needed after all. In this case, invisibility could become a feasible technology within a generation. If optical metamaterials are needed, they will rely on structuring on extremely short scales, possibly on sub-nanometer distances. The technology for making such structures will be developed because the silicon-electronics industry will need them; but whether large-scale devices with sub-nanometer structures can be made remains to be seen.

Another practical challenge is impedance managing. Ideal cloaking devices require materials with equal electric and magnetic response because they implement geometries and geometries are universal—they act on both the electric and the magnetic fields of electromagnetic waves like light. In practice, broadband optical materials mostly respond to the electric field but not to the magnetic one. Optical magnetism has been demonstrated with metamaterials,³⁹ but only in narrow regions of the spectrum. If the electric response differs from the magnetic response, the electromagnetic impedance is mismatched, which results in reflections. One could reduce such reflections by using smooth refractive-index profiles as appropriate antireflection coatings.

Most probably, cloaking devices will be rigid shells; to make them flexible like wearable invisibility cloaks poses a significant challenge. The reason is that their optical properties must be adjusted to their geometrical shapes, as the refractive-index profile of a cloaking device depends on its shape. If the shape changes, the index-profile must follow suit. The required optical properties should be calculated in real time, and the material should change accordingly. Liquid crystals could adjust their optical properties, but controlling a large, complicated array of liquid crystals with possibly several layers appears to be difficult, despite the progress made in liquid-crystal displays.

Summary

A cloaking device is a passive device made of a transparent material that guides light around any object in its interior as if the light has passed through empty space. The cloaking device conceals the object and hides the act of hiding itself. Perfect cloaking devices are impossible because they require materials where the speed of light approaches infinity. Imperfect cloaking devices could be made. Such devices implement suitable curved-space geometries. For electromagnetic microwaves, cloaking devices are definitely within reach of the present technology. Whether invisibility in the visible range of the spectrum will become a reality is not entirely clear yet. Most probably, this will depend more on the new theoretical research than on advances in new materials, and on the application of mathematical intelligence, intuition, and imagination.

-
- ¹ A. Alu and N. Engheta, Achieving transparency with plasmonic and metamaterial coatings, *Physical Review E* **72**, 016623 (2005).
- ² G. W. Milton and N.-A. P. Nicorovici, On the cloaking effects associated with anomalous localized resonance, *Proceedings of the Royal Society London A* **462**, 3027 (2006).
- ³ Y. Lai, H. Chen, Z.-Q. Zhang, and C. T. Chan, Complementary Media Invisibility Cloak that Cloaks Objects at a Distance Outside the Cloaking Shell, *Physical Review Letters* **102**, 093901 (2009).
- ⁴ U. Leonhardt, Optical Conformal Mapping, *Science* **312**, 1777 (2006).
- ⁵ J. B. Pendry, D. Schurig, and D. R. Smith, Controlling Electromagnetic Fields, *Science* **312**, 1780 (2006).
- ⁶ J. B. Pendry, D. Schurig, and D. R. Smith, Controlling Electromagnetic Fields, *Science* **312**, 1780 (2006).
- ⁷ U. Leonhardt and T. G. Philbin, Transformation Optics and the Geometry of Light, preprint arXiv:0805.4778, to appear in *Progress in Optics*.
- ⁸ U. Leonhardt and T. G. Philbin, Transformation Optics and the Geometry of Light, preprint arXiv:0805.4778, to appear in *Progress in Optics*.
- ⁹ U. Leonhardt, Optical Conformal Mapping, *Science* **312**, 1777 (2006).
- ¹⁰ J. B. Pendry, D. Schurig, and D. R. Smith, Controlling Electromagnetic Fields, *Science* **312**, 1780 (2006).
- ¹¹ D. Schurig, J. J. Mock, B. J. Justice, S. A. Cummer, J. B. Pendry, A. F. Starr, and D. R. Smith, Metamaterial Electromagnetic Cloak at Microwave Frequencies, *Science* **314**, 977 (2006).
- ¹² U. Leonhardt, Optical Conformal Mapping, *Science* **312**, 1777 (2006).
- ¹³ D. Schurig, J. J. Mock, B. J. Justice, S. A. Cummer, J. B. Pendry, A. F. Starr, and D. R. Smith, Metamaterial Electromagnetic Cloak at Microwave Frequencies, *Science* **314**, 977 (2006).
- ¹⁴ D. Schurig, J. J. Mock, B. J. Justice, S. A. Cummer, J. B. Pendry, A. F. Starr, and D. R. Smith, Metamaterial Electromagnetic Cloak at Microwave Frequencies, *Science* **314**, 977 (2006).
- ¹⁵ D. Schurig, J. J. Mock, B. J. Justice, S. A. Cummer, J. B. Pendry, A. F. Starr, and D. R. Smith, Metamaterial Electromagnetic Cloak at Microwave Frequencies, *Science* **314**, 977 (2006).
- ¹⁶ D. Schurig, J. J. Mock, B. J. Justice, S. A. Cummer, J. B. Pendry, A. F. Starr, and D. R. Smith, Metamaterial Electromagnetic Cloak at Microwave Frequencies, *Science* **314**, 977 (2006).
- ¹⁷ F. E. Wagner, S. Haslbeck, L. Stievano, S. Calogero, Q. A. Pankhurst, and P. Martinek, Before striking gold in gold-ruby glass, *Nature* **407**, 691 (2000).
- ¹⁸ D. Schurig, J. J. Mock, B. J. Justice, S. A. Cummer, J. B. Pendry, A. F. Starr, and D. R. Smith, Metamaterial Electromagnetic Cloak at Microwave Frequencies, *Science* **314**, 977 (2006).
- ¹⁹ W. Cai, U. K. Chettiar, A. V. Kildishev, and V. M. Shalaev, Optical cloaking with metamaterials, *Nature Photonics* **1**, 224 (2007).
- ²⁰ W. Cai, U. K. Chettiar, A. V. Kildishev, and V. M. Shalaev, Optical cloaking with metamaterials, *Nature Photonics* **1**, 224 (2007).
- ²¹ C. M. Soukoulis, S. Linden, and M. Wegener, Costas M. Soukoulis, Stefan Linden, and Martin Wegener, Negative Refractive Index at Optical Wavelengths, *Science* **315**, 47 (2007).
- ²² C. M. Soukoulis, S. Linden, and M. Wegener, Costas M. Soukoulis, Stefan Linden, and Martin Wegener, Negative Refractive Index at Optical Wavelengths, *Science* **315**, 47 (2007).
- ²³ J. Yao, Z. Liu, Y. Liu, Y. Wang, C. Sun, G. Bartal, A. M. Stacy, and X. Zhang, Optical Negative Refraction in Bulk Metamaterials of Nanowires, *Science* **321**, 930 (2008).
- ²⁴ J. Valentine, S. Zhang, T. Zentgraf, E. Ulin-Avila, D. A. Genov, G. Bartal, and X. Zhang, Three-dimensional optical metamaterial with a negative refractive index, *Nature* **455**, 376 (2008).
- ²⁵ U. Leonhardt and T. G. Philbin, General relativity in electrical engineering, *New Journal of Physics* **8**, 247 (2006).
- ²⁶ [11] J. Yao, Z. Liu, Y. Liu, Y. Wang, C. Sun, G. Bartal, A. M. Stacy, and X. Zhang, Optical Negative Refraction in Bulk Metamaterials of Nanowires, *Science* **321**, 930 (2008).

-
- ²⁷ J. Valentine, S. Zhang, T. Zentgraf, E. Ulin-Avila, D. A. Genov, G. Bartal, and X. Zhang, Three-dimensional optical metamaterial with a negative refractive index, *Nature* **455**, 376 (2008).
- ²⁸ U. Leonhardt and T. G. Philbin, General relativity in electrical engineering, *New Journal of Physics* **8**, 247 (2006).
- ²⁹ U. Leonhardt and T. Tyc, Broadband Invisibility by Non-Euclidean Cloaking, *Science* **323**, 110 (2009).
- ³⁰ U. Leonhardt and T. Tyc, Broadband Invisibility by Non-Euclidean Cloaking, *Science* **323**, 110 (2009).
- ³¹ H. Chen and C. T. Chan, Time delays and energy transport velocities in three dimensional ideal cloaking devices, *Journal of Applied Physics* **104**, 033113 (2008).
- ³² U. Leonhardt and T. Tyc, Broadband Invisibility by Non-Euclidean Cloaking, *Science* **323**, 110 (2009).
- ³³ M. Born and E. Wolf, *Principles of Optics* (Cambridge University Press, Cambridge, 1999).
- ³⁴ U. Leonhardt and T. Tyc, Broadband Invisibility by Non-Euclidean Cloaking, *Science* **323**, 110 (2009).
- ³⁵ U. Leonhardt and T. Tyc, Broadband Invisibility by Non-Euclidean Cloaking, *Science* **323**, 110 (2009).
- ³⁶ D. Schurig, J. J. Mock, B. J. Justice, S. A. Cummer, J. B. Pendry, A. F. Starr, and D. R. Smith, Metamaterial Electromagnetic Cloak at Microwave Frequencies, *Science* **314**, 977 (2006).
- ³⁷ R. Liu, C. Ji, J. J. Mock, J. Y. Chin, T. J. Cui, and D. R. Smith, Broadband Ground-Plane Cloak, *Science* **323**, 366 (2009).
- ³⁸ R. Liu, C. Ji, J. J. Mock, J. Y. Chin, T. J. Cui, and D. R. Smith, Broadband Ground-Plane Cloak, *Science* **323**, 366 (2009).
- ³⁹ C. M. Soukoulis, S. Linden, and M. Wegener, Costas M. Soukoulis, Stefan Linden, and Martin Wegener, Negative Refractive Index at Optical Wavelengths, *Science* **315**, 47 (2007).