

THIS FILE IS MADE AVAILABLE THROUGH THE DECLASSIFICATION EFFORTS AND RESEARCH OF:

# THE BLACK VAULT

THE BLACK VAULT IS THE LARGEST ONLINE FREEDOM OF INFORMATION ACT / GOVERNMENT RECORD CLEARING HOUSE IN THE WORLD. THE RESEARCH EFFORTS HERE ARE RESPONSIBLE FOR THE DECLASSIFICATION OF THOUSANDS OF DOCUMENTS THROUGHOUT THE U.S. GOVERNMENT, AND ALL CAN BE DOWNLOADED BY VISITING:

[HTTP://WWW.BLACKVAULT.COM](http://www.blackvault.com)

YOU ARE ENCOURAGED TO FORWARD THIS DOCUMENT TO YOUR FRIENDS, BUT PLEASE KEEP THIS IDENTIFYING IMAGE AT THE TOP OF THE .PDF SO OTHERS CAN DOWNLOAD MORE!

PRS-TEN-90-004  
2 JUNE 1990



**FOREIGN  
BROADCAST  
INFORMATION  
SERVICE**

# ***JPRS Report***

# **Environmental Issues**

***JAPAN: RESPONSE STRATEGIES  
FOR GLOBAL WARMING STUDIED***

19980515 151

REPRODUCED BY  
U.S. DEPARTMENT OF COMMERCE  
NATIONAL TECHNICAL INFORMATION SERVICE  
SPRINGFIELD, VA. 22161

**DTIC QUALITY INSPECTED 3**

**DISTRIBUTION STATEMENT A**

Approved for public release;  
Distribution Unlimited

ENVIRONMENTAL ISSUES

JAPAN: RESPONSE STRATEGIES FOR GLOBAL WARMING STUDIED

CONTENTS

IMPACT AND RESPONSE STRATEGIES  
CONCERNING CLIMATE CHANGE

TABLE OF CONTENTS

	<u>CONTENT</u>	<u>PAGE</u>
	TABLE OF CONTENTS	
	LIST OF MEMBERS OF SUBGROUPS	
I.	FOREWORD -----	1-1 TO 1-1
II.	BACKGROUND -----	2-1 TO 2-6
III.	SUBGROUP FOR IMPACT ASSESSMENT -----	3-1 TO 3-54
3-1	THE CO2 CYCLE (BY M.TANAKA) -----	3-1
3-2	PROBLEMS REGARDING THE CIRCULATION OF CARBON ON A GLOBAL SCALE (BY Y. KITANO) -----	3-6
3-3	GLOBAL WARMING AND OCEANIC CARBON CYCLE (BY I. SUGIMURA) -----	3-10

3-4	CLIMATE CHANGE SCENARIO AS A PRECONDITION TO THE EVALUATION OF SOCIO-ECONOMIC IMPACTS OF CLIMATE CHANGES (BY T. MATUNO)	3-15
3-5	EFFECTS ON PRODUCTIVITY AND DISTRIBUTION OF TERRESTRIAL VEGETATION (BY A. FURUKAWA)	3-25
3-6	EFFECTS ON AGRICULTURE IN JAPAN (BY Z. UCHIJIMA)	3-28
3-7	EFFECTS ON FORESTS (BY T. INOUE)	3-31
3-8	EFFECTS ON AIR QUALITY (BY T. OKITA AND N. WASHIDA)	3-37
3-9	EXPERIMENTAL STUDIES OF TEMPERATURE EFFECT ON THE FORMATION OF PHOTOCHEMICAL OXIDANTS (BY N. WASHIDA)	3-40
3-10	EFFECTS ON WATER AND ENVIRONMENTAL CONDITIONS (BY K. HANAKI)	3-44
3-11	IMPACTS ON INDUSTRIES (BY S. NISHIOKA)	3-49
3-12	INFLUENCE OF METEOROLOGICAL ENVIRONMENT ON HEALTH (BY T. SASAKI)	3-53
IV.	SUBGROUP FOR RESPONSE STRATEGIES	4-1 TO 4-66
4-1	IMPACTS OF CARBON DIOXIDE EMISSION ON ENERGY SUPPLY AND DEMAND (T. SUZUKI)	4-1
4-2	ULTRA LONG TERM ENERGY SCENARIOS (BY K. YAMAJI)	4-7
4-3	INTERPRETATION OF CO2 CONTROL SCENARIOS (BY Y. KAYA)	4-11
4-4	TRACE GASES WHICH AFFECT GLOBAL WARMING AND PREVENTIVE COUNTER-MEASURES (BY H. AKIMOTO)	4-15
4-5	THE EFFECT OF GLOBAL WARMING ON AGRICULTURE AND COUNTER-MEASURES FOR AGRICULTURE (BY T. UDAGAWA)	4-23
4-6	ENERGY SAVING IN MOTOR CARS (BY Y. SHIDOU)	4-28
4-7	TECHNOLOGICAL MEASURES IN THE DESIGN AND USE OF BUILDING TO COUNTERACT THE EFFECTS OF GLOBAL WARMING (BY S. TANAKA)	4-33
4-8	THE APPLICATION OF APPLIED TECHNOLOGIES FOR THE FIXATION OF CARBON DIOXIDE (BY H. KOMIYAMA)	4-37
4-9	THE EFFECT OF EMISSION CONTROL ON GREENHOUSE AND WARMING RELATED GASES AND THE CURRENT COUNTERMEASURES USED IN ENVIRONMENTAL POLLUTION CONTROL (BY H. AKIMOTO)	4-43

4-10 THE PROBLEM OF GLOBAL WARMING: DEVELOPING COUNTRIES' PERSPECTIVES  
(BY H. SAZANAMI) ----- 4-50

4-11 POLICY OPTIONS FROM A REPORT BY US EPA (BY S. NISHIOKA) ----- 4-56

LIST OF MEMBERS OF SUBGROUPS

I. SUBGROUP FOR IMPACT ASSESSMENT

1) CHAIRMAN

-YASUSHI KITANO: PROFESSOR EMERITUS, NAGOYA UNIVERSITY

2) MEMBERS

-TAKAO INOUE: DIRECTOR, PLANT ECOLOGY SECTION, FOREST ENVIRONMENTAL DIVISION, FORESTRY AND FOREST PRODUCTS RESEARCH INSTITUTE, MINISTRY OF AGRICULTURE

-ZENBEI UCHIJIMA: PROFESSOR, FACULTY OF SCIENCE, OCHANOMIZU WOMEN'S UNIVERSITY

-TOSHIKAZU OKITA: PROFESSOR, FACULTY OF LITERATURE, OBIRIN UNIVERSITY

-YUKIO SUGIMURA: DIRECTOR, GEOCHEMICAL RESEARCH DIVISION, METEOROLOGICAL RESEARCH INSTITUTE, METEOROLOGICAL AGENCY

-MASAYUKI TANAKA: PROFESSOR, FACULTY OF SCIENCE, TOHOKU UNIVERSITY

-SHUZO NISHIOKA: DIRECTOR, ENVIRONMENTAL MANAGEMENT SECTION SYSTEMS ANALYSIS & PLANNING DIVISION, NATIONAL INSTITUTE FOR ENVIRONMENTAL STUDIES, ENVIRONMENT AGENCY

-MICHIO HASHIMOTO: ADVISOR FOR THE MINISTER OF ENVIRONMENT AGENCY

-KEISUKE HANAKI: ASSOCIATE PROFESSOR, FACULTY OF ENGINEERING, UNIVERSITY OF TOKYO

-AKIO FURUKAWA: DIRECTOR, TERRESTRIAL ECOLOGY SECTION, ENVIRONMENTAL BIOLOGY DIVISION, NATIONAL INSTITUTE FOR ENVIRONMENTAL STUDIES, ENVIRONMENT AGENCY

-TAROU MATUNO: PROFESSOR, FACULTY OF SCIENCE, UNIVERSITY OF TOKYO

-TAKESHI MUROTA: PROFESSOR, FACULTY OF ECONOMICS, HITOTSUBASHI UNIVERSITY

-NOBUAKI WASHIDA: DIRECTOR, ATMOSPHERIC CHEMISTRY SECTION, ATMOSPHERIC ENVIRONMENT DIVISION, NATIONAL INSTITUTE FOR ENVIRONMENTAL STUDIES, ENVIRONMENT AGENCY

## II. SUBGROUP FOR RESPONSE STRATEGIES

### 1) CHAIRMAN

-YOUICHI KAYA: PROFESSOR, FACULTY OF ENGINEERING, UNIVERSITY OF TOKYO

### 2) MEMBERS

-HAJIME AKIMOTO: DIRECTOR, ATMOSPHERIC ENVIRONMENT DIVISION, NATIONAL INSTITUTE FOR ENVIRONMENTAL STUDIES, ENVIRONMENT AGENCY

-TAKETOSHI UDAGAWA: DIRECTOR, DEPARTMENT OF ENVIRONMENTAL MANAGEMENT, NATIONAL INSTITUTE OF AGRO-ENVIRONMENTAL SCIENCES, MINISTRY OF AGRICULTURE, FORESTRY AND FISHERY

-OSAMU KOBAYSHI: DUPUTY DIRECTOR, ENVIRONMENTAL PROTECTION DEPARTMENT, TOKYO ELECTRIC POWER COMPANY

-HIROSHI KOMIYAMA: PROFESSOR, FACULTY OF ENGINEERING, UNIVERSITY OF TOKYO

-HIDEHIKO SAZANAMI: GENERAL MANAGER, UNITED NATIONS CENTER FOR REGIONAL DEVELOPMENT

-YOSHITOMO SHIDOU: GENERAL MANAGER, TECHNICAL DEPARTMENT, JAPAN AUTOMOBILE MANUFACTURERS ASSOCIATION INC.

-TOSHIHARU SUZUKI: PROFESSOR, FACULTY OF ECONOMICS, NAGOYA UNIVERSITY

-SAZUKU TANAKA: MANAGER, PLANNING AND INFORMATION DEPARTMENT, KAJIMA INSTITUTE OF CONSTRUCTION TECHNOLOGY

-SHUZO NISHIOKA: DIRECTOR, ENVIRONMENTAL MANAGEMENT SECTION, SYSTEMS ANALYSIS & PLANNING DIVISION, NATIONAL INSTITUTE FOR ENVIRONMENTAL STUDIES, ENVIRONMENT AGENCY

-AKIO MORISHIMA: PROFESSOR, FACULTY OF LAW, NAGOYA UNIVERSITY

-KENJI YAMAJI: MANAGER, ENERGY ECONOMICS DEPARTMENT, ECONOMIC RESEARCH CENTER, CENTRAL RESEARCH INSTITUTE OF ELECTRIC POWER INDUSTRY

## I . FOREWORD

This report contains the proceedings carried out between January and June 1989 by the subgroups of the Advisory Committee on Climate change whose aim was to assess the environmental impacts and to evaluate response strategies. This follows the first interim report submitted in November 1988 by the Advisory Committee on climate change. This volume contains summaries of the reports given by the members of the subgroups.

Interest in the global warming effect has seen a soaring increase over the past year. However, a comprehensive and in-depth understanding of the problem is quite difficult to attain even among specialists within the field. Furthermore, the studies being conducted by the IPCC(Intergovernmental Panel on Climatic Change) on the scientific aspects, environmental and socio-economic impacts, and response strategies have not yet laid down any guidelines. Thus, with this background in view, these groups have conducted their own investigations on similar categories as is being considered by IPCC, in order to sort out the issues involved in the problem. Although this report was prepared with the intension of integrating all knowledge on the issue, it cannot be said to cover all views currently held both inside and outside of Japan.

To cope with the global warmig problem, considerations of more specific issues are needed. The present interim report, although not as comprehensive as desired, has been made public with the intention of providing a starting point in the assessment of our common and needed efforts which are necessary in order to assess and deal with the issue of global warming more effectively.



## II . BACKGROUND

The Advisory Committee on Climate Change in the Environment Agency which addresses on the Global Warming Problem was established on May 30th 1988. It's aim is to organize the scientific information available and to give direction to the national policy on the issue. Since its establishment, five general and three subcommittee meetings have been held in order to consider the present status of measures being taken with respect to global warming problem both within Japan and abroad; as well as to evaluate the present level of scientific knowledge on the problem, identifying specific areas requiring research, and to determine specific measures which need to be taken at the national level. On November 2nd 1988, the first interim report was published. In that report, there was a recommendation to gather more scientific data, and it called for the establishment of guidelines on preventive actions, contributions on establishing an international consensus on the issue, promotion of specific and important research projects as well as educational activities on the issue; establishing a unified system to promote preventive measures and research activities. The recommendations in the report were reflected in the Japanese government's action policy prepared for the first meeting of the UNEP/WMO who sponsored the IPCC meeting held in November of the same year. This greatly contributed to the Japanese government's efforts in establishing a coordinated plan of action with the international community in the task of dealing with the problem of global warming.

As a result of the events described above, the IPCC created three working groups which specialize in the gathering of scientific data, the assessment of environmental-social effects and preventive strategies. Japan participates in all three groups, and also has the position of co-chairman in the second working group of the IPCC. In order to accommodate the requirements involved in

these activities, the Advisory Committee on Climate Change created impacts and also response strategies subgroups in January 1989 in order to further study the agenda put before IPCC and to seek concrete actions that could best contribute to the aim of IPCC. The Environment Agency itself sent representatives to each of the IPCC working groups to announce the Japanese government's intentions to take an active role in the organization's activities. In line with the policies generating such activities, Japan, as the chairman of the D-group of the second working group will compile reports on the effects of global warming on energy, industry, transport, air quality, UV-B, health and human settlement as well as taking a role as the chairman of the energy and industry subgroup of the third working group.

Also, as a result of IPCC's inquiry into the global warming problem becoming more diversified spanning many governmental administrative fields, an organizational arrangement was carried out by the Ministry of Foreign Affairs. As regards arrangement for the D group (Renamed as the Fifth Section later) of the second working group and the Energy and Industry Subgroup of the third working group, the Environment Agency and the Ministry of International Trade and Industry were designated respectively to be responsible for overall administration and operation under coordination of the Ministry of Foreign Affairs. Responsibilities for other tasks have been distributed to the related ministries. This arrangement allows the various ministries and agencies to cooperate together in drawing up reports which are relevant worldwide.

The Summit Meeting on Protection of the Global Atmosphere held in the Hague in March 1989 at the suggestion of the heads of state of France, the Netherlands and Norway initiated an increased awareness of the need to lay down ordinances concerning the global warming through political decisions. The Minister of the

Environment Agency, Mr. Aoki, attended the summit on behalf of Prime Minister Takeshita. "Declaration of the Hague" adopted in this summit had several important principles.

- a) The principle of developing new institutional authority which shall involve such decision-making procedures as may be effective even if, on occasion, unanimous agreement has not been achieved;
- b) The principle that this institutional authority undertake or commission the necessary studies, ensure the circulation and exchange of scientific and technological information; develop instruments and define standards;
- c) The principle of appropriate measures to promote the effective implementation of the decisions of the new institutional authority;
- d) The principle that countries bearing an abnormal or special burden shall receive fair and equitable assistance to compensate them;
- e) The negotiation of the necessary legal instruments to provide an effective and coherent foundation, institutionally and financially, for the aforementioned principles.

In response to those moves, a wider international consensus was formed on the need to have a basic convention defining the framework of measures against the global warming problem.

In a session of the steering committee of the IPCC's third working group held from 10th - 12th of May in Geneva, a decision was made to begin considering the following items. They are: (1) legal measures and processes, (2) technology transfer and

development, (3) financial measures (especially assistance to developing countries), (4) public information and education and (5) economic measures. Reports on these items are to be compiled by the autumn of 1989. Also, a further action was that the resolution was unanimously adopted by the 103 nations participating in the fifteenth session of the governing council of the UNEP. This resolution included an agreement of the participating members to initiate diplomatic negotiations within UNEP with respect to framework convention on climatic change following the interim report which is to be submitted to IPCC by autumn 1990.

As described above, there has been a great increase in momentum over a year, on international efforts to initiate research into the problem of global warming. There is, already, an international consensus not only to press forward with scientific and technological evaluation of the problem led by IPCC, but also to begin consideration of the framework convention covering the issue.

Japan, in consequence, must further promote research into the problem in the light of the international commitment she has already pledged.

Table-1 Scope of Work of IPCC

	Sub-Group	Lead Authors	Covered Issues
WG1 Chairman: Houghton(UK) Vice-Chairman Moura(Brazil) Seck(Senegal)	Section 1	USA, Sweden	Changes in Climate Forcing Agents
	Section 2	USA, France	The Relative Importance of Climate Forcing Agencies
	Section 3	USA, UK, USSR	The earth's Climate: Changes and Variability
	Section 4	USA, France	Processes and Modelling
	Section 5	USA, UK,	Model Simulations of Past and Present Climate
	Section 6	UK, FRG, USA, Japan	Model Predictions and Uncertainties
	Section 7	Netherlands, UK	Sea Level Rise
	Section 8	USA, Brazil, UK	Ecosystem Dynamics and Interactions with the Atmosphere
	Sub-Group	Chairman	Covered Issues
WG2 Chairman: Izrael(USSR) Vice-Chairman Hashimoto (Japan) To be identified (Australia)	Section 1	USA, USSR, IIASA	Prediction of Future Climate
	Section 2	UK, USSR, India	Agriculture, Forestry and Land-use
	Section 3	Canada, USSR	Environmental and Socio-economical Impacts
	Section 4	USA, USSR, Algeria	Hydrology and Water Resources
	Section 5	Japan, USSR	Energy, Industry, Transport, Air Quality, UV-B, Health, Human Settlement
	Section 6	USA, USSR	World Ocean and Cryosphere
	Section 7	Canada, USSR	Climate change and Cryosphere (permafrost issues)

	Sub-Group	Chairman	Covered Issues
WG3 Chairman: Bernthal (USA) Vice-chairman Ferguson (Canada) Jibing(China) Attard(Malta) Vellinga(NL) Karimanzira (Zimbabue)	Energy and Industry	Japan, China	Technology and poli- cies which could reduce the emission of greenhouse gases, Select appropriate analytical tools to examine the effects of technological and policy options, Categorize the op- tions by the timing of their potential application, analyze nearer term options, Prepare plan to cre- ate, or further develop and analyze longer term options
	Agriculture, Forestry, ETC	FRG, Zimbabue	Issues related to limi- tation of greenhouse gas emissions created by human activities such as deforestation and agricultural activities
	Coastal Zone Management	New Zealand, Netherlands	Adaptation to sea level change impacts etc.
	Resource Use and Manage- ment	France, India	Agriculture, Fisheries, Animal husbandry, Forests, Wildlife, Biological diversity including preservation of species, national parks, and biosphere reserves, Other Ecosystems, Water Resources
	Steering Group	USA etc.	Base emissions fore- casts, taking into account population and economic growth in different regions Implementation mecha- nisms

### III . SUBGROUP FOR IMPACT ASSESSMENT

#### 3-1 THE CO<sub>2</sub> CYCLE (BY M. TANAKA, TOHOKU UNIVERSITY)

The increase of the concentration of CO<sub>2</sub> in the atmosphere since 1958 is equivalent to about 58% of the emission from fossil fuel (Fig.1-1). The concentration of CO<sub>2</sub> in the atmosphere has gradually been increased since middle of the 18th century (Fig.1-2). The causes are cultivation of the forest and the consumption of fossil fuel (Fig.1-3). The forest emission in recent years is supposed to be one severalth of that from fossil fuel, though we couldn't make any quantitative estimation.

The box model, the advective-diffusive model, the outcrop-diffusion model including the box-diffusion model, and many other similar models have been used for the explanation of the global carbon cycle. Each model is insufficient in treating the biosphere, and unsatisfactory in explaining the ocean absorption. From the present models dealing with the ocean absorption, a cut of CO<sub>2</sub> emission by a period of several decades to one hundred years. We still, however, have to cope with a long-term increase of the CO<sub>2</sub> concentration.

The origin of the glacial-interglacial cycle could be due to the combined effects of alteration of the earth's orbit and variation of the CO<sub>2</sub> concentration. The variation of CO<sub>2</sub>, however, can not be explained from the change of sea water solubility due to the change of sea water temperature between glacial and interglacial periods.

The concentration of atmospheric CO<sub>2</sub> is essentially regulated by the CO<sub>2</sub> partial pressure of the surface sea water. The partial pressure of CO<sub>2</sub> is determined by the concentration of total CO<sub>2</sub> (i.e., sum of the concentrations of molecular CO<sub>2</sub>, HCO<sub>3</sub><sup>-</sup> and

CO<sub>3</sub><sup>2-</sup>) in the surface layer of the sea. Many attempts have been made to explain the change of total CO<sub>2</sub> between glacial and interglacial periods by varying sea water circulation and the corresponding change of biological activities. For these relation, however, there seems to be no conclusive understanding. Fig.1-4 shows an example of such ideas.

In the pre-industrial age, the ratio of carbon amounts contained in the atmosphere and in the ocean is about 1 to 60. Assuming this condition to be equilibrium including the depth of the sea and the biosphere, present models show that the CO<sub>2</sub> added to the atmosphere by human activities will be distributed to the atmosphere and to the ocean by the ratio of about 1 to 6. If the biosphere acts as a sink, the quantity of the CO<sub>2</sub> distributed to the sea will be less than the above ratio.

The absorption of CO<sub>2</sub> by the land plants is considered to take place through the duplicated effects that a high concentration of CO<sub>2</sub> in the atmosphere causes active photosynthesis resulting an enhanced CO<sub>2</sub> absorption, and that an increase of the land plants causes more photosynthesis resulting also an enhanced CO<sub>2</sub> absorption. Thus, the CO<sub>2</sub> absorption and the time required to reach the equilibrium can be greatly affected by the modeling of the plants activities.

The subjects in the future study are as follows:

- 1) To intensify the monitoring of the CO<sub>2</sub> concentration in the atmosphere including isotopic ratios such as <sup>13</sup>C/<sup>12</sup>C and <sup>14</sup>C/<sup>12</sup>C,
- 2) to advance the research on the ocean circulation applying appropriate chemical and radioactive tracers,
- 3) to develop the research on the CO<sub>2</sub> chemistry of the sea water including effects of biological activities,
- 4) to advance the research on the CO<sub>2</sub> exchange between the atmos-



phere and the ocean, and between the atmosphere and the land biosphere,

- 5) to advance the research on the past concentration of CO<sub>2</sub> including such ratios as  $\delta^{13}\text{C}$  and  $\Delta^{14}\text{C}$ , by analyzing antarctic ice sheet cores, deep sea cores and tree-rings,
- 6) to explain the phenomena of glacial-interglacial cycles,
- 7) to establish the quantitative models to understand the global carbon cycle.

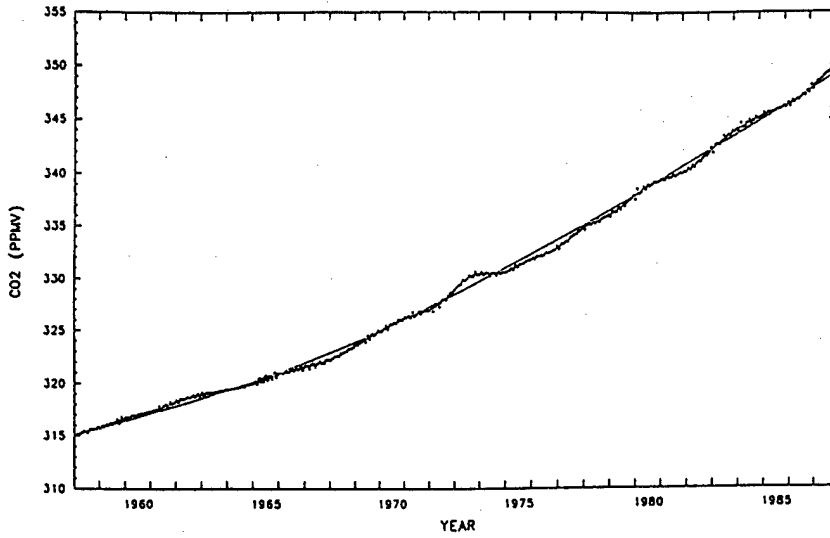

Fig.1-1 Observed and Calculated Long-term CO2 Trends at Mauna Loa, Hawaii

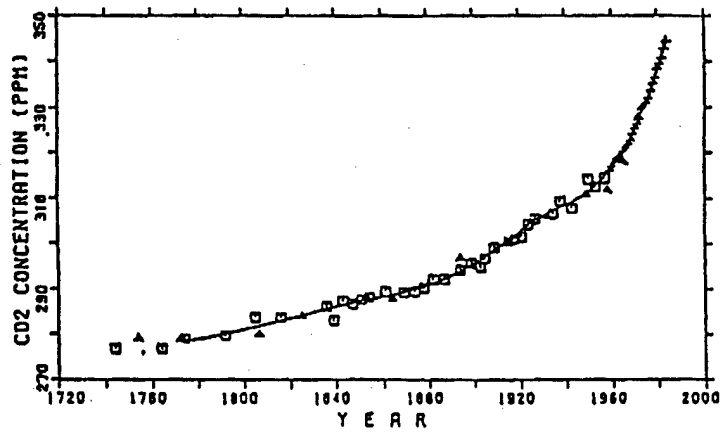

Fig.1-2 The secular trend of the concentration of atmospheric CO2 estimated from ice core analyses at Siple Base, Antarctica (Neftel et.al., 1985)

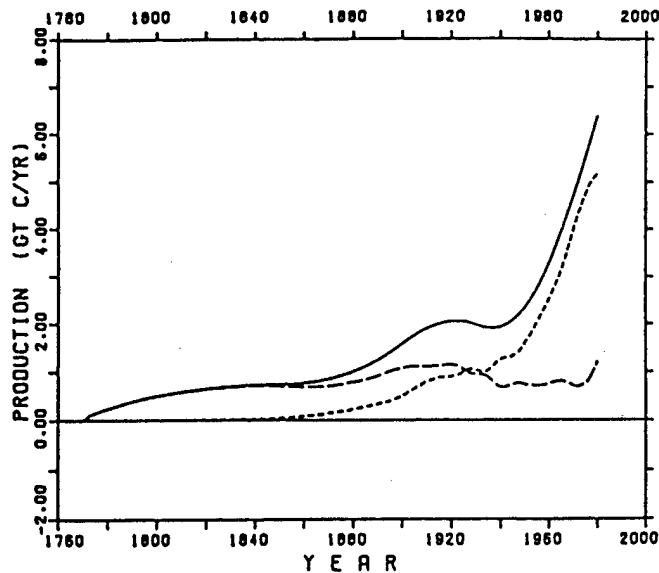

Fig.1-3 CO<sub>2</sub> production rate obtained by deconvolving the measured CO<sub>2</sub> increase using the outcrop-diffusion model. Solid line: total production; short-dashed line: fossil fuel input; long-dashed line: difference = biospheric input (Siegenthaler and Oeschger, 1987).

TRANSITION INTERGLACIAL → GLACIAL

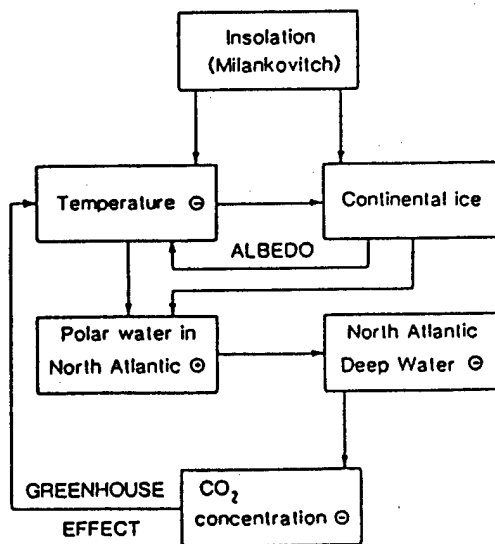

Fig.1-4 A scenario of the possible connection between processes in the combined climate-CO<sub>2</sub> system at the onset of an ice age (Siegenthaler, 1988)

3-2 PROBLEMS REGARDING THE CIRCULATION OF CARBON ON A GLOBAL SCALE (BY Y. KITANO, NAGOYA UNIVERSITY)

1) Absorbtion of Carbon Dioxide by the Forests and the Oceans

In 1985 Dr. K. Yoda examined the mass balance of carbon on a global scale from a forest ecological point of view and showed that A in the following equation is equal to 2.5 Gt (Gigaton = 1 billion tons), F=5.2Gt and S=2.1 Gt (1985). According to the following equation, L should be 0.6 Gt. However forest ecologists as well as Dr. Yoda emphasize that forests yearly supply approximately 1.8 Gt of carbon into the atmosphere as L. Now suppose that L is 1.8Gt and A and F are as above, S should be 4.5Gt. However, since S is considered to be around 2.1Gt, this contrast should become a big problem.

$$A = F - S \pm L$$

Here unit:  $10^{15} \text{g.C year}^{-1}$

A: Yearly increase in amount of atmospheric CO<sub>2</sub>

F: Yearly amount of CO<sub>2</sub> emission by fossil fuel to atmosphere

S: Yearly amount of absorbtion by oceans

L: Yearly amount of CO<sub>2</sub> emission from terrestrial ecosystems

Geophysicists propose the unidimensional model on the global air circulation analysis and the latitudinal distribution of CO<sub>2</sub> and point out that forests are in "a steady state" and L should be nearly zero. Therefore S should be 2.7Gt. From their own experiences on the observation L, geochemists want to support the idea of geophysicists as well.

The opinions regarding the mass balance of carbon, that is, the

source and sink of atmospheric CO<sub>2</sub> on a global scale are not unified and the problem here attributes especially to the present situation that there is still much to study about absorption by the oceans.

## 2) Effect of Diffusion of Light and Carbon Dioxide on Forest Production

Dr. T. Oikawa performed a simulation for the effect of an increase in atmospheric CO<sub>2</sub> on forests and pointed out the following: 1) Assimilation of organic substances does not always increase with increasing concentration of atmospheric CO<sub>2</sub>, unless the transport of carbon dioxide in the air is carried out effectively; 2) In tropical forests, if the concentration of atmospheric CO<sub>2</sub> goes over 400ppm, the growth of upper leaves in forests becomes eminent and the light does not reach the middle and lower parts of the forests, and the trees in the middle and lower parts disappear and, as a result, forests become extinct (1987).

Dr. Oikawa points out that this kind of effect on plant production followed by diffusion of light and carbon dioxide needs to be considered, when the assimilation of carbon by forests is discussed.

## 3) Behavior of Carbon in the Oceans

When atmospheric carbon dioxide increases, H<sub>2</sub>CO<sub>3</sub> in sea water also increases and the concentration of carbonate ion (CO<sub>3</sub><sup>2-</sup>) in seawater increases. (See reaction formula 1)

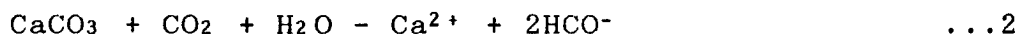
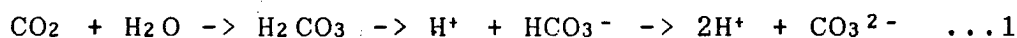

Sea water is almost saturated with calcium carbonate ( $\text{CaCO}_3$ ). However the following expression is wrong; " When atmospheric  $\text{CO}_2$  increases,  $\text{CO}_3^{2-}$  in sea water increases and  $\text{CaCO}_3$  precipitates," It is true that calcium carbonate in water dissolves, when  $\text{CO}_2$  dissolves into the water (See Reaction formula 2). Also when calcium carbonate is formed, in the formula 2 the right moves to the left and one  $\text{CO}_2$  molecule is to be released. This means that one carbon dioxide molecule is reduced by  $\text{CaCO}_3$  formation but at the same time another one carbon dioxide molecule is emitted into air. Thus it is not always appropriate to say that  $\text{CO}_2$  is reduced when calcium carbonate is formed. Furthermore  $\text{CO}_2$  is consumed on sea surface to form organic substances and can be fixed as organic substances. But it should be noticed that only 0.008% of the organic substances on the surface reach the bottom and all the rest dissolves in the oceans.

#### 4) Amount of Carbonate formed in the Oceans

The amount of carbonate formed yearly on the surface of seawater is approximately 0.7Gt, where about 80% is carbonate formed by plankton in open sea and about 20% is substances from coral in coastal sea. And most of the 0.7Gt of calcium carbonate dissolves in seawater and only about 0.2Gt remains yearly as marine sediment. This figure of 0.2Gt actually comes from calcium carbonate decomposed and dissolved in or on the ground. This means that  $\text{CaCO}_3$  existing on the ground merely moves to the oceans to sediment, and we must keep it in mind that there is little change in the net amount of  $\text{CaCO}_3$  in the earth, because increase of  $\text{CaCO}_3$  in the oceans means decrease of  $\text{CaCO}_3$  on the ground. We need to consider that more calcium carbonate on the ground is dissolved when the concentration of atmospheric carbon dioxide in the air increases.

Due to the consumption of fossil fuel, annual emission of carbon

dioxide into the air adds up to about 5Gt as carbon, and we must realize this situation before we have ideas to remove this enormous amount of carbon dioxide through the increase of coral.

3-3 GLOBAL WARMING AND OCEANIC CARBON CYCLE (BY I. SUGIMURA,  
METEOROLOGICAL AGENCY)

Recent global warming issue is essentially originated from disturbance of natural carbon cycle through human activity. However, as to the carbon cycle, the basic problem has not yet been solved. And the items on Table 3-1 still need to be studied from now on. Under the circumstances of many unsolved matters, it is of utmost importance to find out how we predict situations coming up in the future.

According to Dr. Wigley the temperature of the sea water as well as air temperature has gone up by 0.5 °C over the last 100 years. This kind of effective result of observation, with which we can evaluate rising temperature is very difficult to find out. And because of a large heat capacity of the ocean, change of air temperature is buffered approximately 70% of the temperature change of the sea water.

As far as the carbon cycle is concerned, it is important to know what will happen to carbon dioxide in the water when the temperature of sea water rises. A one degree rise in temperature moves up partial pressure of carbon dioxide by 4% and total carbonic acid increases by 0.4%. As the temperature rises, the amount of carbon dioxide absorbed in to the ocean changes and in some areas absorption turns to emission. The result of observation for the last 20 to 30 years shows that the partial pressure in the surface water rises yearly about 1.5ppm along with an increase in the carbon dioxide concentration in the air.

The upper layer of the ocean, surface to 50 or 100 meter deep, is believed to respond relatively quickly to the increase of carbon dioxide in the air. But in the deep sea, under thousands meters, this response is not so quick due to its slow twin over time.



The changes predicted in the physical structure of warming oceans are the following: a) Salinity on the surface decreases, the temperature on the surface rises and the surface stabilizes; b) Mixing from the deep decreases and marine productivity also decreases; c) If the antarctic circumpolar current gets strong, the western boundary current also strengthens; d) If the equatorial trade wind gets weak, equatorial upwelling decrease. However, with the computer system we have now in our country it is technically impossible to predict ocean currents change.

The sea level is considered to have gone up by 10 to 20 cm over the last century. The causes for this are said to be thermal expansion of seawater and melting ice, but there are no definite conclusions. As for Japanese observations, the sea level was at its peak in 1950 and has been coming down even since. But we cannot come up with any kind of conclusion from this result, because this result is related to coastal movement. The formula used to predict the change of sea level was drawn from the change of around 0.5 degree in the past, and it is questionable if we can adapt this formula to 2 to 3 degree changes in temperature in the future. It is predicted that if the sea level goes up 1m, 35km<sup>2</sup> out of 100km<sup>2</sup> of Tokyo city area will be under water.

When we look at the CO<sub>2</sub> exchange between the air and the oceans, the two forces a) Temperature (solubility) Pump - T.forcing and b) Plankton Pump - P.forcing are working and "source" and "sink" are decided depending on the strength of each forcing. Of all the oceans the portion of T.forcing is estimated to be about 20 to 40% of P.forcing. Here it is important to know which forcing effects partial pressure of oceanic carbon dioxide. Also, work of Plankton Pump depends basically on light intensity, the amount of nutrient and temperature. Net Dissolution of Excess CO<sub>2</sub> from the air is only about 5% of oceanic carbon cycle and is difficult to fix the amount of the incoming. Contemporary oceanic carbon

balance is shown as on Fig. 3-1.

Regarding the effect of changes in carbon dioxide on oceanic ecosystems, though there are direct and indirect effects, there should be no direct changes. As to indirect effect, if the surface current and temperature change, local balance of oceanic ecosystems will be disturbed significantly.

There is little information on the oceanic warming at the time of double CO<sub>2</sub>. Therefore, change of ocean is estimated approximately by the comparison between January and July sea surface temperature. Sea surface temperature changes along with the distribution and the isothermal line of 10 degree moves northward from off the coast of Sanriku up to the Kuril Islands. As the result, the zone of subarctic front moves up north and Plankton pump (P.forcing) decreases. At the same time the transport of carbon dioxide into the ocean decreases, and the overall effect of this is still unknown. We cannot discuss the marine food-web just from the point of view of temperature effect, and the situations of proliferation are believed to change depending on interaction with light intensity, nutrient. However, ecological study on this field has not been conducted.

When we look at fishes as a whole, which eat zoo plankton, the relation between the number of plankton and the amount of marine resources except sardine is fixed in catch. It is still open to question to predict an increase or decrease of catch only by the rise of water temperature and to fix the quantity is a problem yet to be solved.

Table 3-1 Provisions to be Solved to Discover Carbon Cycle

- 1-1) Amount of future emission of CO<sub>2</sub> from fossil fuel
  - 2) Economical and technological causes of future emission
  - 3) History of CO<sub>2</sub> emission in the past
  
- 2-1) Time Series/annual cycle/Regional Changes of CO<sub>2</sub> in the atmosphere
  - 2) Change of CO<sub>2</sub> in the atmosphere in the last hundreds to millions of years
  - 3) Whether carbon cycle was stable before being disturbed by human beings
  
- 3-1) Whether terrestrial ecosystems are at equilibrium with CO<sub>2</sub> in the air, and if this is "Source" or "Sink".
  - 2) Changes of amount in CO<sub>2</sub> interexchange between terrestrial ecosystems and air
  - 3) Effect of disorder of forests and soil
  - 4) Whether the average flux between air and terrestrial ecosystems has changed in the last 100 years
  
- 4-1) Temporal/Spatial changes in exchange between air/ocean CO<sub>2</sub>
  - 2) Absorbtion rate of CO<sub>2</sub> from air into the ocean
  - 3) CO<sub>2</sub> transport from the surface into the deep sea
  
- 5-1) If there is any "Source" or "Sink" which has not been considered up to now
  - 2) If there is any possibility that a big change happens to CO<sub>2</sub> flux

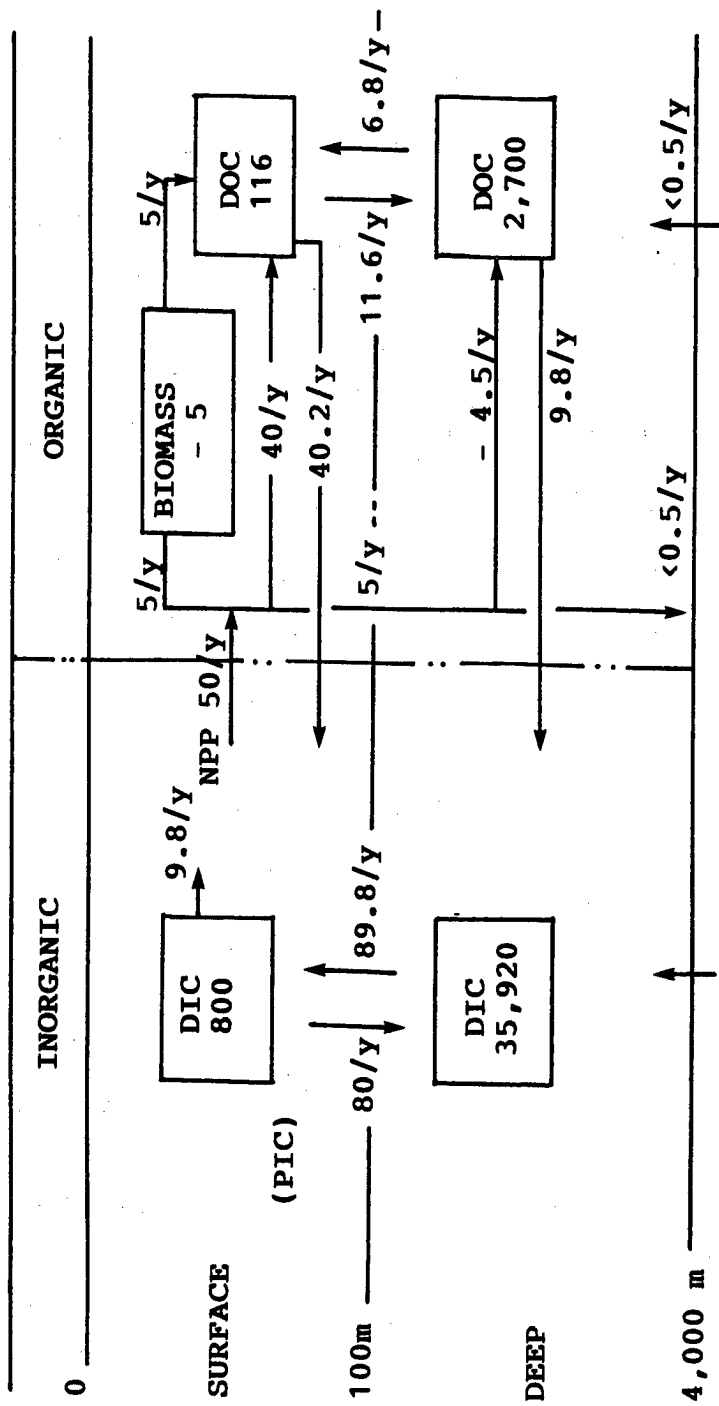

FIG. 3-1 CONTEMPORARY OCEANIC CARBON BALANCE (GT)

Note:  
 DOC: Dissolved Organic Carbon  
 DIC: Dissolved Inorganic Carbon  
 NPP: Net Primary Production  
 PIC: Particulate Inorganic Carbon

3-4 CLIMATE CHANGE SCENARIO AS PRECONDITION TO THE EVALUATION OF  
SOCIO-ECONOMIC IMPACTS OF CLIMATE CHANGES  
(BY T. MATSUNO, UNIVERSITY OF TOKYO)

1) Necessity of detailed scenario

In order to predict the effects of global warming on human activities, we need to prescribe a precondition as climate changes. For example, to evaluate effects on agricultural production we need to know average monthly temperature, precipitation, amount of solar radiation and atmospheric back radiation. However, with numerical models we have now, we cannot get detailed information about their quantities on regional scale, though the people especially involved in effect evaluation require detailed scenarios of climate changes on regional scale rather than the information about global climate change.

2) Problems in Numerical Model Results

Regarding the climate change scenario as a precondition to evaluate effects, the rough climate changes on a global scale have been estimated by numerical experiments for the state of equilibrium (assuming that the CO<sub>2</sub> concentration becomes double and the state lasts forever) and also for the case where CO<sub>2</sub> concentration increases gradually. The results of the numerical experiments are available. However, any of the existing model results cannot be used to predict characteristics of climate change in Japanese regions, because their spatial resolution is insufficient.

For example, in the GISS model by Hansen, grid distance is 700 by 800Km and in the MRI model 400 by 500Km. In the GFDL model by Manabe, variables are expressed by superposition of waves without using grid, and the shortest wave length is 3,000Km. If this

resolution is translated into Grid distance, it corresponds to a value between GISS and MRI. Therefore, even if the results of these models can be trusted, we can hardly make a distinction between the regions, such as North East Japan and South West Japan, or the Japan Sea Side or the Pacific Ocean Side. There is a more serious problem that results of numerical experiments so far made are quite scattered so far as regional characteristics of predicted climate change are concerned. For example, some models predict an enhancement of the Indian summer monsoon while other models do not, even though zonally averaged features of the change of precipitation are more or less similar among all model. In some cases we can trace back the origin of a discrepancy and judge which result is more reliable. But in most cases it is very difficult to determine what model result is reliable and what one is not at the present state of knowledge. In short we cannot derive one scenario as "best model result" or as "consensus model result".

### 3) Consideration on possible measurements to take at present

#### a. Utilization of numerical models

Since there are no appropriate models which can be directly used to infer regional climate changes, it is difficult to predict the future climate in Japan. Until reliable models are developed, it is necessary to investigate the characteristics of individual models available at present to find ways how to use the calculated results. For instance, if a simulation of the present climate doesn't work well in some respects owing to defects of a model, the simulated results related to the defects should be excluded. After such procedure, it is necessary to find out the average or common features of climate changes seen in various models. But the simulated results of the available models vary largely from one to another and there are few notable common changes other

than temperature increase. Thus it is almost impossible to deduce a scenario of climate change from model results. Even in this case, if the magnitude changes is estimated with some certainty, it will be possible to infer how various effects are sensitive to climatic changes. We can estimate the range or magnitude of the effects of the climate change on various human activities on the basis of such data. In short it will be possible to conduct a sensitivity study. Here, we shall prepare such data to be used as preconditions for this purpose.

b. Qualitative assessment

Qualitative information such as whether the monsoons in Southeast Asia will become stronger or weaker could be used as a sort of climatic scenario. Though it is difficult to deduce such qualitative information solely from model results, we may be able to select a particular scenario with the help of physical considerations.

c. Inference based on past observational data

Using the data of past climatic changes, we can infer the future climate. Namely, based on the observation of the climates during the warm period in the last hundred years we can infer the climate in the age of the global warming. For instance, it is known that it was warm in the northern hemisphere from 1930s to 1940s: it was cold at the beginning of the twentieth century. The difference of the average global temperatures between these two periods is  $0.3^{\circ}\text{C}$  to  $0.5^{\circ}\text{C}$ . Then it will be possible to extrapolate the trend from the differences of climatic situations between the two periods. But this method, in my opinion, is not dependable, because the climate variations of this magnitude in the past hundred years are likely to have occurred from some other mechanisms than global warming caused by an increase of carbon dioxide.

d. Inference based on paleoclimatic data

This method similarly refers to climatic changes over such a long period as ten millennia. It is well known that 5,000 to 8,000 years ago the Sahara was full of greenery. This climatically warm period is called Hypsithermal Age (climatic optimum). During this period the amount of insolation in summer in the northern hemisphere was more than that of today due to the earth's orbital changes and therefore it was warmer at least on hemisphere-scale. It is supposed that the situation is more or less similar to the one due to an increase of CO<sub>2</sub>. All the data show that the temperature was on the whole quite high in summer. So, it seems reasonable to use the paleoclimate data of this period to infer the climate under the increased CO<sub>2</sub> conditions especially for the inference of precipitation distribution. However, in theory insolation was stronger in summer in the northern hemisphere in this period, so the continents got warmer and the difference of land and sea temperatures was bigger, hence monsoons were stronger. As the whole mechanism to determine the precipitation at that time is different from that which will work in the CO<sub>2</sub> warming climate. It is not appropriate to think all the data are applicable. Another problem is that the paleoclimate is investigated by analyzing pollen in sedimentary soil; the pollen reflects the weathers in summer when plants grow, but not those in winter.

e. About the Jomon transgression

It is well known that in the Jomon period, about 5,000 to 8,000 years ago, the sea level was 4 to 5 meters higher than now: there are shell mounds scattered around in Kanto area along the then coastlines. The period coincides with Hypsithermal Age, and it was considered that the sea level was higher because ice bed melted because of the high temperature in that period.



The biggest ice age was 18,000 years ago, and it was 12,000 years ago when ice started to melt rapidly. About 7,000 years ago, when the Jomon transgression was seen, the ice in the final ice age almost finished melting. When the sea level gets higher, the sea becomes heavier, the land becomes relatively lighter and the earth crust has to rise to recover the isostasy. But the earth crust moves slowly and there arises a time lag: the sea level has already risen but the land has not yet risen accordingly. Therefore, it is appropriate to conclude that the Jomon transgression is the primary phenomenon seen between the time when ice bed melted and the sea level rose, and the subsequent time when the heavy sea and light land were adjusted: it was not caused by global warming by 2° to 4°C.

#### 4) Consideration on climatic change scenarios in Japan and East Asia

Based upon the ideas mentioned in paras a. to d. of 3), I have worked on climatic changes in Japan and East Asia by comparing and examining MRI and several other models in order to study the preconditions of effect assessment (tables 4-1, 2, 3, 4). Under the present circumstance that regional climatic changes cannot be calculated by reliable numerical models, it is impossible to infer future climate with quantitative and objective judgement: what I can do is to decide the input data for effect assessment based on a subjective judgement.

In the MRI model in Table 4-1 the temperature near Japan in winter is calculated to rise as much as 16 degrees. This is due to the fact that in the model snow and ice albedo is assumed very high, and in the present-day climate the temperature is calculated to be very low and sea ice extends near Japan. Global warming results in melting sea ice and a big rise of temperature.

Cases like this which can be attributed to model defects with clear reasons, I believe, should be excluded in contemplation for possible scenarios.

The MRI and other models share fairly common grounds: rainfall decreases around 20-30 degrees of north latitude, and soil moisture decreases accordingly. And it has proven right that in the cold outbreak area the temperature generally increases very much, and the winter monsoon become weaker. The change in the amount of rainfall around Japan is supposed to be little because Japan located about the middle of rain-decreasing subtropical areas and rain-increasing middle and high latitude areas. However, more detailed studies are to be done before anything definite can be said.

As a result of the quantitative study based on the models, it has proven possible that monsoon circulation during summer in the tropical area strengthens, and monsoons weaken during winter. The difficult point is a question of soil wetness: when temperature rises, rainfall increases, but at the same time evaporation increases, so there is a possibility that dryness may develop in soil moisture.

An important change which can be predicted with certainty is that rainfall becomes tropical, therefore very unstable. It is expected to become torrential rain, which is discernible in the numerical models. When it pours, water will not seep into the soil in Japanese terrains, but flow away. Consequently water stored in the soil decreases, which will lead to dryness.

JAPAN

Elements	Models	MRI	GFDL	GISS
Temperature C		+8 -- +12	+5 -- +6	+3 -- +3.5
Ground temperature C		+10 -- +16	+4 -- +5	+4
Precipitation mm/day		0 -- +1	+1 -- +2	0 --- -1
Evapotation				
Soil moisture g/cm <sup>2</sup>		0 -- +1		0 --- -1
Run off mm/day			0+	0±
Amount of water vapor		X1.5	X1.3	X1.1 -- 1.2
Relative humidity				
Amount of cloud %			0+	
Insolation		+10% -- +20%	-10%	0 --- -10%
Wind direction, wind velocity		NW -> WNW	0	0
Pressure pattern and other characteristics		high in west-low in east type --changes little monsoon -- changes little (north-weakens)	south coast of Japan -- low strengthens monsoon -- weakens(-20%)	south of Japan -- NW strengthens

Table 4-1 Comparison of numerical model results of climatic changes (December - February)

JAPAN

Elements	Models	MRI	GFDL	GISS
Temperature C		+6 -- +7	+3 -- +4	+3 -- +3.5
Ground temperature C		+6 -- +7	+4	+3 -- +3.5
Precipitation mm/day		0-	-1 --- -2	0-
Evapotation				
Soil moisture		0-- -2	0+	0-
Run off				
Amount of water vapor				
Relative humidity				
Amount of cloud %				
Insolation		+25%	+5 -- +10%	+10%
Wind direction, wind velocity		Small change	S-SSW→ SSW-SW	Small change
Pressure pattern and other characteristics		high in south- low in north --strengthens a little	western Japan --Δ p+ western Japan to Asian conti- nent -- sub- tropical high strengthens	East China Sea, South China Sea --Δ p+ Japan-- +

Table 4-2 Comparison of numerical model results of climatic changes (June - August)

East Asia						
Elements	Models	MRI	GFDL	GISS		
Temperature C		60° N +10< 45° N +10 Eq +2--+3	60° N +8 45° N +6 Eq +1--+2	60° N +7 45° N +4--+6 Eq 3 (inside Asian continent +more)		
Ground temperature C						
Precipitation mm/day		Near Japan +1 East of China, Indochina		east of China, East China Sea -1 Indochina, Bay of Bengal +2		
Evaporation						
Soil moisture		50° N< - southeast of China, Indo China -1-- -3	20° N --30° N continent others - 0			
Run off						
Amount of water vapor		30° N < X1.5 Eq X1.1	30° N < X1.2 Eq X1.1	40° N X1.2 Eq X1.2		
Relative humidity						
Amount of cloud %			35° N < +0 35° N < -5			
Insolation				40° N -10% 20° N -- 40° N 0+ Eq -- 20° N 0-		
Wind direction, wind velocity						
Snow depth			50° N< + 50° N< -2			
Pressure pattern and other characteristics		Center of Siberian high --goes south Around 160° N -- low pressure zone p<0 (notable in Asian continent)		50° N Δ p- Eq -- 30° N p+ Siberian high -- weak originally, no change (1016--1016) south of Japan -- monsoon strengthens		

Table 4-3 Comparison of numerical model results of climatic changes (December - February)

East Asia

Elements	Models	MRI	GFDL	GISS
Temperature C		East Siberia max +8 30° N +5 Eq +2	Siberia max +7 30° N +3 Eq +2	Siberia Δ T small +3 China--Central Asia +5 Eq +3
Ground temperature C		Siberia +8 Tibet +10	Siberia +10 Hsinchiang +12	incoherent
Precipitation mm/day		China, East Siberia +2		
Amount evaporation mm/day		India, Indonesia +		
Soil moisture g/cm2		All upper areas of continent 30° N -- 40° N -3 Indochina, Burma +	Bay of Bengal, Assam +16 China -	India, South- east Asia 0-
Run off mm/day				
Amount of water vapor				
Relative humidity				
Amount of cloud				
Insolation w/m2		30° N -- 60° N +10-20% other 0-	East of China, East Siberia, Japan + West of China, India -	East of China, Siberia, Japan + Tibet, Central Asia -
Wind direction, wind velocity		South of Japan --easterly	South of Japan --high press- ure-like	South of Japan --high press- ure-like
Snow depeth				
Pressure pattern and other characteristics		monsoon low -- strengthens Indian monsoon -- strengthens	10° N--40° N upper continent p + West of western Japan -- subtropical high streng- thens Indian monsoon -- weakens?	Indian monsoon low-- weakens a little

Table 4-4 Comparison of numerical model results of climatic changes (June - August)  
Note) MRI: Meteorological Research Institute.

3-5 EFFECTS ON PRODUCTIVITY AND DISTRIBUTION OF TERRESTRIAL  
VEGETATION (BY A. FURUKAWA, NATIONAL INSTITUTE FOR  
ENVIRONMENTAL STUDIES)

Classified by photosynthetic types, plants are divided into three types; C<sub>3</sub>, C<sub>4</sub> and CAM species (Table 5-1). The responses of photosynthesis to environmental conditions and photosynthetic rates are different among the three types. The ratio of photosynthetic rates is C<sub>3</sub>:C<sub>4</sub>:CAM=5:10:1. The saturated CO<sub>2</sub> concentration is 500-600 ppm for C<sub>3</sub> species and 200-300 ppm for C<sub>4</sub> species. Thus photosynthetic rate in C<sub>4</sub> species is saturated with the present concentration of CO<sub>2</sub>.

The following effects is conceivable at elevated CO<sub>2</sub> concentration:

- 1) The photosynthetic rates of C<sub>3</sub> species increase with higher CO<sub>2</sub> concentrations, but remain constant or decrease for C<sub>4</sub> species. Extra carbon fixed at elevated CO<sub>2</sub> levels is partitioned entirely into starch. Accumulated starch causes the physical damage to chloroplasts and reduces the photosynthetic rates.
- 2) Usually plants close their stomata at elevated CO<sub>2</sub> concentrations, but a certain poplar species does not. As shown in Fig. 5-1, photosynthetic rate of poplar species with unresponsive stomata was not enhanced at elevated CO<sub>2</sub> concentration.
- 3) As the stomatal aperture is decreased, the transpiration rate is reduced even when the rate is estimated on a plant individual base.
- 4) Water use efficiency is increased due to both a reduction in transpiration attributed to decreased stomatal conductance and

an increase in photosynthetic and growth rates under high CO<sub>2</sub> concentration. Plants grown at elevated CO<sub>2</sub> concentration increases the resistance to water stress.

- 5) The experimental results on the effect of elevated CO<sub>2</sub> concentration on the dry matter partitioning show that the dry matter growth of root and stem increased markedly, but leaf dry weight or area increases slightly. Furthermore, effects on seed production and germination have not been recognized.
- 6) Effects on height growth is different among species of the same community. The competition of light acquisition determines the survival of species. Consequently, species composition in the secondary succession will be quite different. Since studies concerning this event have been rare, though it is necessary to know how plant community will change with increasing CO<sub>2</sub> concentration, it is important to study this research theme from now on.

Table 5-1 Photosynthetic characteristics of C<sub>3</sub>, C<sub>4</sub>, and CAM species

Characteristics	C <sub>3</sub>	C <sub>4</sub>	CAM
Photosynthetic rate	15-40	36-80	1-5
CO <sub>2</sub> compensation point	40-70	0-10	0-200 (diurnally changed)
Concentration of standard CO <sub>2</sub>	500-600	200-300	?



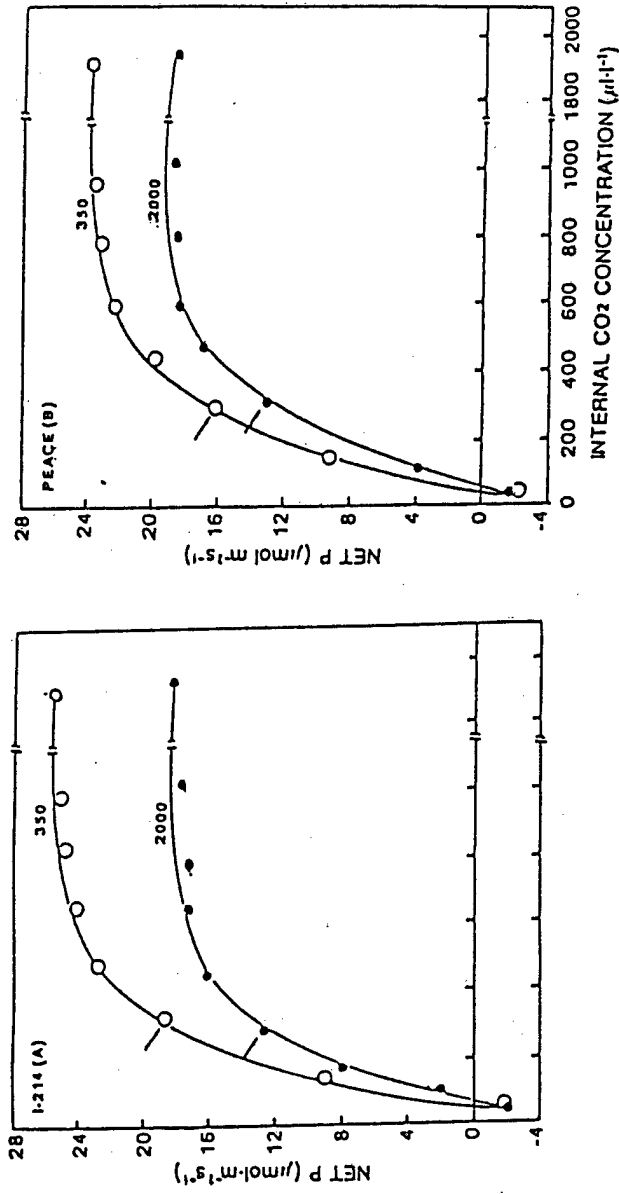

Fig. 5-1 Relation between CO<sub>2</sub> and photosynthetic rate of poplars grown at 350 or 2000 ppm CO<sub>2</sub> for 3 weeks. Peace poplar has stomata unresponsive to CO<sub>2</sub> and other environmental conditions. (Park and Furukawa, unpublished)

3-6 EFFECTS ON AGRICULTURE IN JAPAN (BY Z. UCHIJIMA, OCHANOMIZU  
WOMEN'S UNIVERSITY)

Changes of carbon dioxide concentration in the air, along with photosynthesis increase and evaporation decrease, disturbance of climate formation process caused by the changes in temperature and hydrological condition, changes in cultivated acreage and water resources caused by a rise of sea level, have effects on the agricultural production and ecosystem (Fig. 6-1).

In my calculation of distribution of effective accumulative temperature (annual accumulation of temperatures of days with average temperature 10°C or more) induced by climatic changes in Japan, when carbon dioxide concentration doubles, it increases by 1,000°C day: the present isoline in the Kanto Plain goes up to as far as the Tsuguru Strait, and the northern limit of subtropical crops shifts to southern Kyushu. Similarly, in my calculation of the average temperatures in July and August, which greatly affect flowering, earing and ripening of Japanese paddy rice, the 25°C isoline moves from northern Kanto Plain to northern Tohoku region, and the 30°C curve appears in western and southern Kyushu and part of Shikoku. When the temperature becomes 30°C, Japonica type of rice will likely be affected by high temperature impediment.

In order to make clear how climatic changes affect plants productivity I made models and made calculation of NPP value (net primary productivity: t dry matter/ha/year); 9% increase nationwide. However, it is based upon an assumption that natural vegetation will move smoothly as the climate changes, and there will be no changes in appearance of plant diseases and pests.

It is conceivable that temperature changes accelerate microbe's activities in the soil, which bring about changes in the amount

of organic matter in the soil, and that gives an impact on soil productivity. The rise in dissolution coefficient of organic matter with temperature changes shows that the dissolution of organic matter in soil is expected to increase about 40%. As a result, at the beginning cultivated land's productivity increases, but as time passes, it can decline quickly. To maintain its productivity it is necessary to apply much organic matter into soil.

There have been many similar studies done in the USA, Australia, the Netherlands and others, but the studies in Japan are behind; further and more studies will bring us more results.

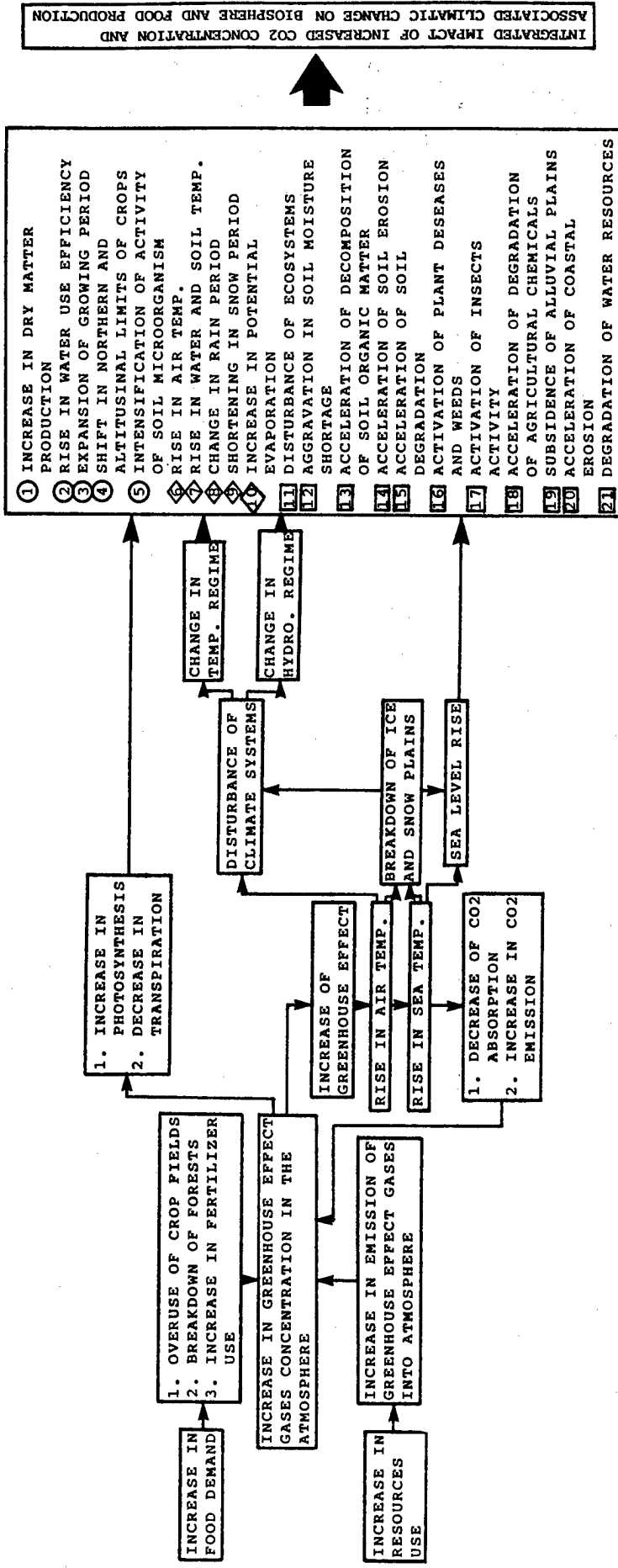

○ PROFITABLE  
 ◇ PARTLY PROFITABLE OR PARTLY ADVERSE  
 □ ADVERSE

Fig.6-1 Possible effects of increased atmospheric carbon dioxide on agriculture and biosphere (Uchijima, 1988)

3-7 EFFECTS ON FORESTS (BY T. INOUE, FORESTRY AND FOREST PRODUCTS RESEARCH INSTITUTE)

1) Effects on forest zones and communities

Effect of global warming on forest zones and communities is shown in Fig.7-1. In a short period, it is conceivable that tree growth increment or phenology such as flowering period changes, hybrid formation is brought about by disturbance to isolated distribution of tree species and distribution area of tree species changes.

In a medium or long period, plant species comprising forest communities start to migrate with a following order: annual plants, perennial plants, shrub and trees, followed by forest zone and community. If the change of temperature condition is directly linked to the migration mentioned above, when the temperature rises 2°C, forest zone or community will migrate 200 to 300 Km along latitude, about 600m in altitude.

2) Effects on tree growth physiology

Effect of temperature rising and little rain on growth is shown in Fig.7-2. Rise of tree temperature and increase of water stress can induce inhibition of photosynthesis rate, resulted in suppression of growth. The relation between daily maximum water vapor requirement and daily amount of transpiration was examined in a Japanese cypress forest. From the relation, transpiration amount in each month was calculated under condition of 3°C rising with the same amount of precipitation at present. It was predicted that the difference between the transpiration amount at the time of 3°C rising and rain amount at present would be minus (shortage of water) at the central part and the Seto Inland Sea area in Japan (Fig.7-3).

Decline of Sugi (Cryptomeria japonica) forests is spreading in

the Kanto Plain in Japan. The distribution of declined forests corresponds not only to that of air pollutants but also to that of areas in a little rain throughout a year and in high level of maximum air temperature in August. In the distributional area, it has recently been getting warmer and drier, and the climatic changes seemed by urbanization are supposed one of causal factors to induce the decline throughout physiological stresses.

3) Formation of annual rings and environmental changes

Width of annual rings, maximum wood density and distributional patterns of density reflect the past environmental conditions, and those parameters change every year. By annual ring analysis with an use of soft X-ray film, some attempts have been made to find out the relations between the parameters and climatic elements. It will be possible to obtain information on more ancient times by applying this method to the timber used for shrines and temples. The relations between the past climatic changes and annual rings are expected to provide important information on effect assessment of future climatic changes.

4) Effects on insects and microbes

Global warming is supposed to affect population distribution or life process of forest insects and microbes. For instance, population distribution of longicorn beetle (*Monochamus alternatus*), which is insect vector of pine wood nematode causing the pine wilt disease, depends mainly on accumulative temperature. Therefore, under rising of air temperature, the distribution area is predicted to spread to the northern parts: when the temperature rises 1.5°C, the present distribution area covering the middle and southern parts of Iwate Prefecture and northern coastal area of Akita Prefecture can spread north to the whole Aomori Prefecture.

5) Problems to be solved

The predictions mentioned above are very limited ones based on assumptions and need further scientific substantiation. There are problems caused by warming such as effects on the forest primary production, fauna, soil, water and heat balance. To clarify these problems and others, there need to be more comprehensive studies on effects of climate changes on the forest ecosystem.

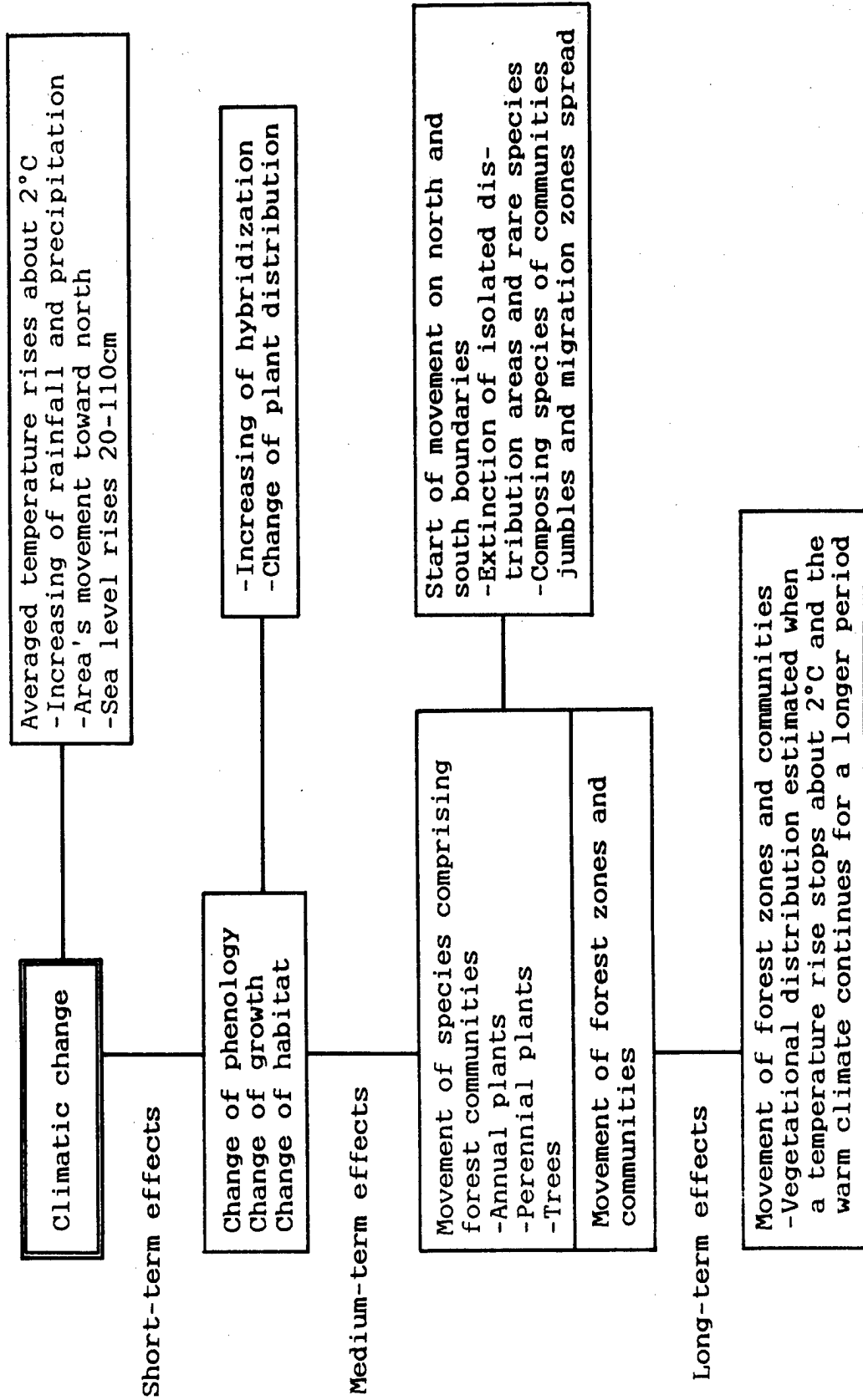

FIG. 7-1 EFFECTS OF A TEMPERATURE RISE ON FOREST ZONES AND COMMUNITIES (SAITO, 1989)



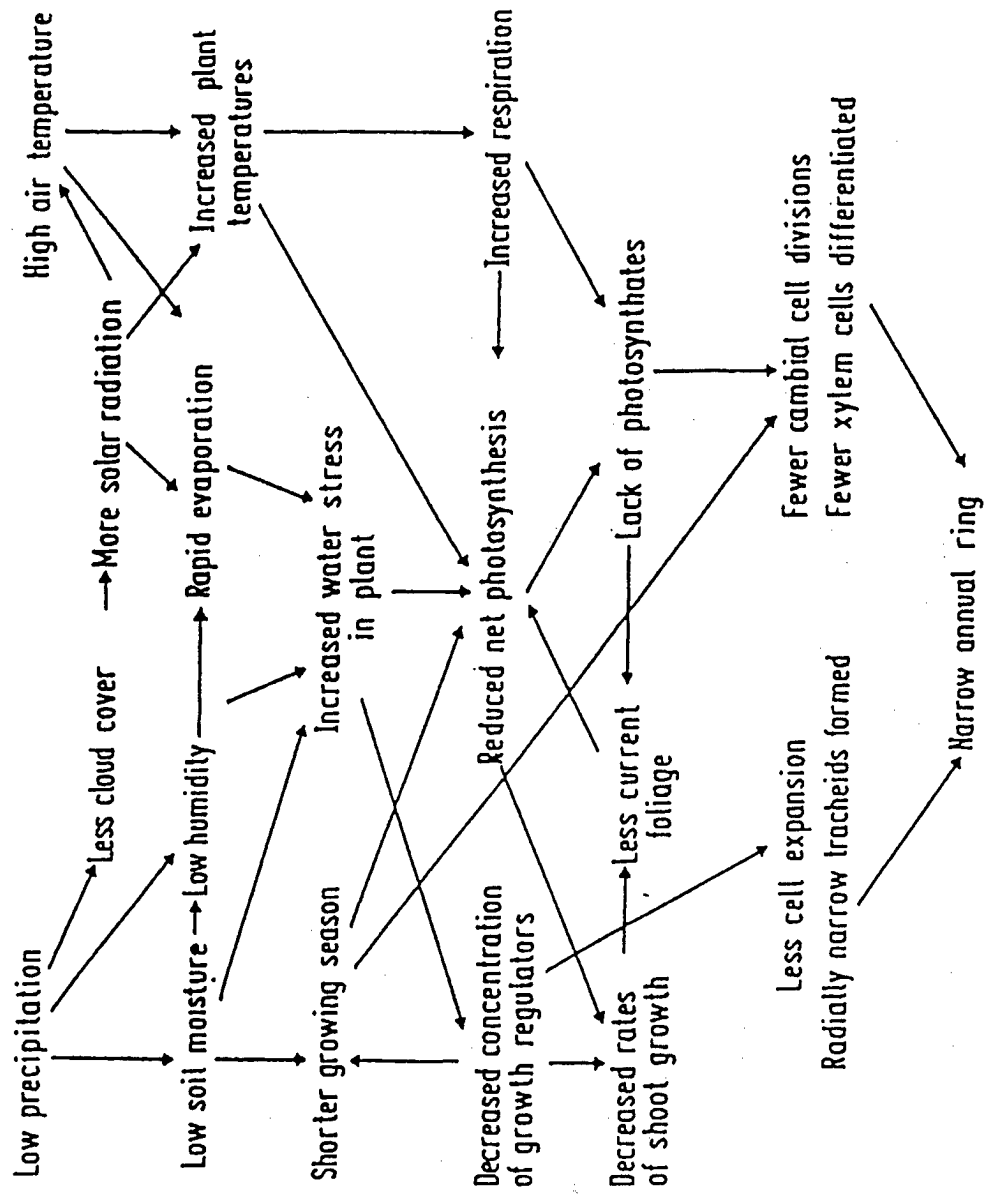

FIG. 7-2 EFFECTS OF HIGH TEMPERATURE AND LOW PRECIPITATION ON GROWTH PROCESS (LARCHER, W: 1973)

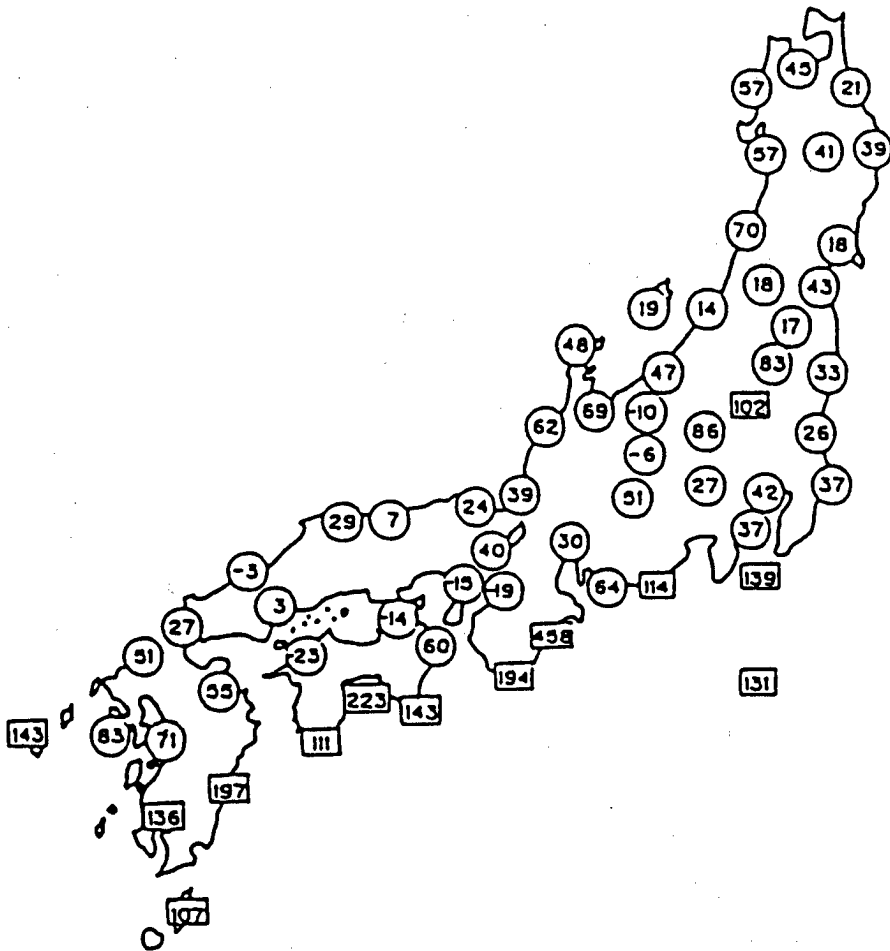

Fig.7-3 Amount of water subtracted transpiration induced by a temperature rise of 3°C from average rainfall in August (mm/month) (Morikawa, Inoue: 1989)

Note: Estimated with a use of a 31-year old Japanese cypress forest. Rainfall is assumed to be the same as the present.

3-8 EFFECTS ON AIR QUALITY (BY T. OKITA, OBIRIN UNIVERSITY AND  
N. WASHIDA, NATIONAL INSTITUTE FOR ENVIRONMENTAL STUDIES)

Fig. 8-1 illustrates several impacts of global warming on air quality. Each impact can be explained as follows:

- 1) Rates of atmospheric chemical reactions and solubility of gases into cloud droplet would change by global warming.
- 2) A change in the frequency and the pattern of cloud cover affects the solar light intensity, which results in a change in the rates of photodissociation of atmospheric gases. 1) and 2) are important for problems of photochemical smog and acid rain.
- 3) Air quality would be influenced by change of climate, such as the stability and circulation pattern of air.
- 4) Increase of humidity and emission rates of trace gases, such as ammonia, DMS, hydrogen sulfide, nitric oxide, terpenes, and methane, etc., might occur according to warming of sea and ground surfaces. Further, atmospheric concentrations of free radicals, such as OH, are expected to be changed.
- 5) Absorption rates of gaseous pollutants such as SO<sub>2</sub>, NO<sub>x</sub> and O<sub>3</sub> by vegetation would change by the change of temperature. 4) and 5) have significant effects on air quality and the photochemical air pollution.
- 6) Increase or decrease of arid area affects the amount of particulate resuspension.
- 7) Energy usage may decrease in winter but may increase in summer. This change alters the anthropogenic emission of SO<sub>2</sub> and

NO<sub>x</sub>.

- 8) Change in precipitation patterns would have effects on the deposition flux in the atmosphere.
- 9) The increase of the emission of SO<sub>2</sub>, NO<sub>x</sub>, and trace gases would bring about an increase of aerosols. This effect, as well as the increase of the amount of particulate resuspension, would lower visibility and would vary albedo.
- 10) Effect of temperature on the formation of photochemical oxidants is important. At present, however, the experimental results obtained by use of photochemical smog chambers and the estimates made by modeling studies are not in good agreement.
- 11) Lovelock proposed a climatic feedback of ecosystems; warming of sea water -> increase of the maritime DMS emission -> increase of aerosol formation -> increase of cloud and, accordingly, cloud albedo -> global cooling (Lovelock Gaia hypothesis). However, this hypothesis still has a room for discussion.
- 12) Regional patterns of acid rain may be changed according to the change of the concentrations and reaction rates of SO<sub>2</sub> or NO<sub>x</sub>.
- 13) Stratospheric cooling is predicted to occur by climatic modeling and it slows chemical reactions in the stratosphere. It is suggested that this effect relieve the depletion of stratospheric ozone.

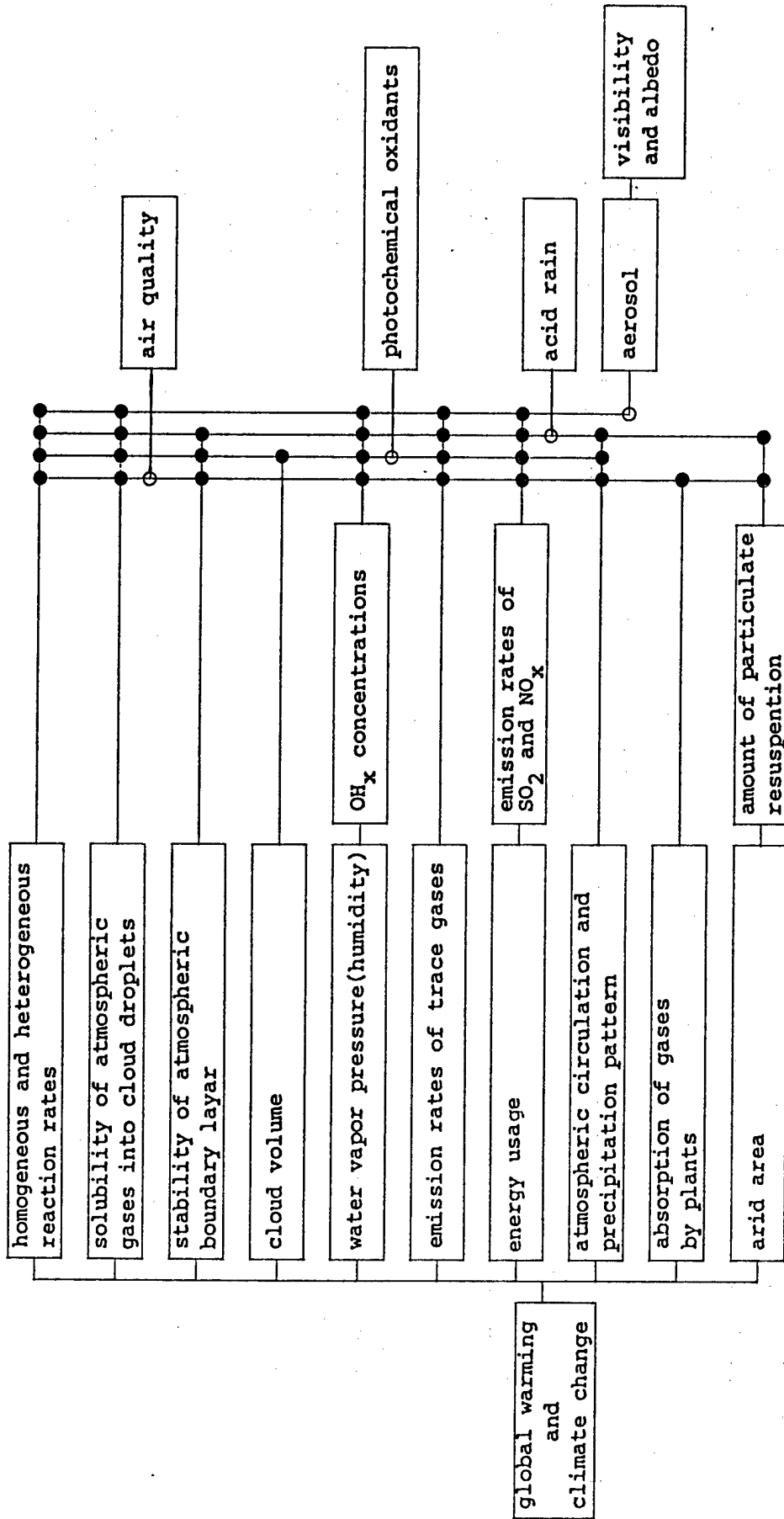

Fig.8-1 Effects of Climate Change on Air Quality

3-9 EXPERIMENTAL STUDIES OF TEMPERATURE EFFECT ON THE FORMATION OF PHOTOCHEMICAL OXIDANTS (BY N. WASHIDA, NATIONAL INSTITUTE FOR ENVIRONMENTAL STUDIES)

As for the effects of global warming on the formation of photochemical oxidants, a few studies have been reported so far. EPA suggested an increase of maximum hourly ozone concentration (1.4% per 1 K) in their report to Congress on the basis of the modeling studies (EKMA model) made by Gery et al. (1987). On the other hand, following four conclusions were reported by Carter et al. (1979) based on a smog chamber study.

- a. Ozone reaches its maximum concentration earlier by temperature increase.
- b. The maximum concentration of ozone is independent of temperature.
- c. Time profile of ozone concentration changes according to temperature increase.
- d. c. is due to dissociation of PAN and concentration of PAN decreases on account of temperature rise.

In order to make these points clearer, several experiments were done at the National Institute for Environmental Studies by use of large volume (6m<sup>3</sup>) photochemical chamber at 30 to 50 °C. The results are as follows.

- a. The speed of the ozone formation (the time for ozone to reach its maximum concentration) is not accelerated remarkably by the increase of temperature. In the chamber experiments there is a formation of nitrous acid (HONO), which is a precursor of OH radicals, on the chamber surface, i.e., NO<sub>x</sub> reacts with water on the surface to give HONO. Since this reaction is dependent on the temperature, a small difference on the speed of the formation of ozone was ob-

served. The difference between the present results and Carters' results may be ascribed to the difference of the surface material of both chambers. This contention was supported by the experiments using methyl nitrite as a surface-independent source of OH radicals. The speed of the formation of ozone was found to be the same at 30 and 50°C. Therefore, it can be concluded that the formation of photochemical smog is not accelerated by the increase of temperature.

- b. Maximum concentration of ozone is not raised by the increase of temperature (see Fig. 9-1). Basically, maximum concentration of hydrocarbons and  $\text{NO}_x$ . In the chamber experiments, there is neither transport nor diffusion. Thus, the maximum concentration of ozone should not be dependent on temperature. It is hard to understand why the conclusion that maximum concentration of ozone is raised depending upon temperature was obtained from EKMA model, since the details of the model is not known well.
- c. High level ozone lasts long at high temperature (see Fig. 9-1). This is due to the thermal dissociation of PAN; PAN decomposes at 50°C fifteen times as fast as at 30°C. PAN dissociates to  $\text{CH}_3\text{COO}_2$  and  $\text{NO}_2$ , and  $\text{NO}_2$  becomes a precursor of photochemical ozone as is known well. Thus, high level of ozone lasts longer at high temperature. It means that the area which is exposed to high concentration of ozone is enlarged by the increase of temperature.
- d. On the other side, the concentration of PAN decreases and the high concentration of PAN does not last long.

According to c. and d., the area affected by photochemical oxidant (ozone) will be enlarged by warming, whereas the effect of PAN will be relieved. The effect of global warming on photochemical smog must be assessed by taking both effect into consideration. Kanto district can be taken for instance. Polluted

air mass of Tokyo is transported by sea breeze into the plains of Kanto and goes into Nagano prefecture beyond the Usui Pass. In such a case the area exposed to high concentration of ozone in Nagano prefecture will be enlarged, but the effect of PAN in the plains of Kanto will be relieved.



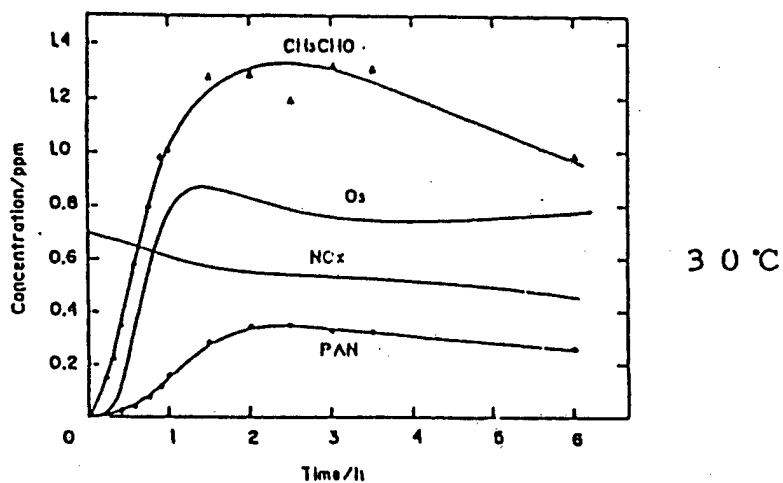
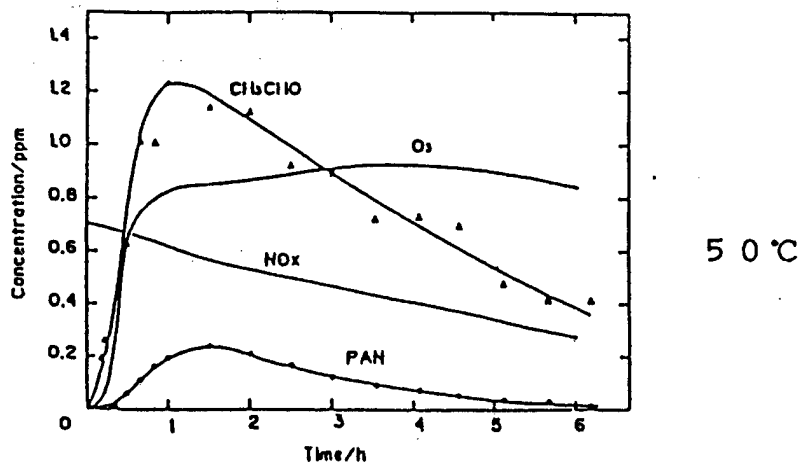

Fig.9-1 Change of O<sub>3</sub>, PAN, CH<sub>3</sub>CHO and NO<sub>x</sub> formed at 50°C and 30°C under an initial condition of C<sub>3</sub>H<sub>6</sub> with a concentration of 2 ppm, NO<sub>2</sub> with 0.5 ppm and NO with 0.25 ppm

Note: O<sub>3</sub> concentration above are adjusted due to a wall effect decrease.

3-10 EFFECTS ON WATER AND ENVIRONMENTAL CONDITIONS (BY K. HANAKI,  
UNIVERSITY OF TOKYO)

1) Necessity of Information on Climate Change

Global climate change is predicted to some extent by utilization of models. However, factors of local climatic conditions are more important than those of average conditions for assessing the effects on water resource system or coastal zone. In order to evaluate the potential impacts on civil and environmental engineering works, it is believed that information on the following points are necessary:

- a. Climate Scenarios: local climatic difference, the effects of ocean currents, the movement of pole air masses, the frequency of unusual weather due to phenomenon of blocking.
- b. Precipitation Scenarios: the size, frequency, and courses of typhoons, the period and position of the rainfront during rainy season and autumn rain falls, change in snowfall and snow accumulation areas.
- c. Sea Scenarios: change in ocean currents, tides and wave field, change in coastal morphology.

2) Premise of Potential Impact Evaluation

Qualitative evaluation of potential effects was made assuming the serious change in climatic conditions for the systems because it is difficult to obtain information mentioned above at this level. This report is focusing on Japan but investigation of other countries, especially Southeast Asian countries, would be necessary.

### 3) The Effects on Water Resource Systems and their Countermeasures

#### a. Flood Control

Capacity of water storage in reservoir will become insufficient. Especially, multipurpose usage of reservoirs (for flood control and water use) will be difficult. Increase of precipitation by intensive heavy rains and the rise of sea level would result into an increase of flood in cities in lower lands. Furthermore, the run-off of soil and sand in the upper and middle part of rivers would be increased. The change in the amount and period of run-off by snowmelt would cause an increase of flood.

Countermeasures for these effects are as follows: diversification of water storage facilities, construction of dam with flood control functions, reinforcement of retardation basin control of run-off in urban areas, prevention of sand accumulation, and the repair of embankments. Usual methods based on the past weather and hydrologic data would be hardly useful for the plans of water storage facilities, embankments, and so forth.

#### b. Water Uses

Decrease of river flow and water storage would decrease water supplies, while water demand increases in summer which would cause an expansion of water shortage.

The following impacts are expected: the decrease and instability of hydropower generation (especially in case of utilizing snowmelt water), the influence of saline water intrusion on agriculture and urban water use, increase in water demand for irrigation, and effects on recreational activities and navigation with the lower water level of rivers and lakes.

Possible countermeasures could be as follows: promotion of utilizing the various types of water resource, practice of interbasin transfers of water, the management and utilization of coastal lakes and groundwater, utilization of urban precipitation, promotion of saving water, improvement of efficiency in water use, development of water re-use systems, and improvement in utilization of agricultural water supply.

c. Water Quality

Possible impacts are as follows: deterioration of river water quality with the decrease of the river flow and the rise of temperature, deterioration of lake water quality with prolonged formation of thermal stratification, acceleration of eutrophication trends, and a fall in water level of lakes.

In order to maintain good water environment, reinforcement of water quality control, conservation of a minimum flow, and grade up of wastewater treatment will be necessary.

4) Effects on Coastal Area and their Countermeasures

a. Coastal Area

The following effects are expected: the lost of land and coastal view by inundation of lower land with rise of sea level and magnitude of typhoons, retreat of coastline through erosion, increase of submergence by flood tide and high waves, intrusion of saline into groundwater in coastal areas, incapability of water drainage because of rising groundwater level.

The measures could be the followings: construction of maintenance facilities, construction and elevating of embankment, artificial nourishment of coast, and reinforcement of

drainage system.

b. Estuaries

The estuary area would expand due to the rise of sea level and decrease of river water, and saline water would invade toward inland area. Furthermore, inundation and erosion of embankment caused by wave energy are expected.

In order to prevent the intrusion of saline water, building of embankment and sea wall could be possible measures.

c. Harbor

The impacts could be damages on harbor caused by erosion and sedimentation and also by flood tide and high waves. Repair and improvement of harbor facilities could be some appropriate measures.

5) Effects on Urban Infrastructure and their Countermeasures

Increased power demand for air conditioners and water demand will necessitate reinforcement of power stations and capacity of water supply. Furthermore, coastal areas would face problems of insufficient bridge clearance and increase of groundwater intrusion into sewer pipes. Comprehensive countermeasures for relative land subsidence will be necessary.

6) Needs for Further Research and Investigation

a. Climate Change Scenario

Prediction technology to provide information mentioned in 1), especially prediction of meteorological phenomenon on local scale and prediction technology of change in ocean currents will require research and investigation.

b. Technology Development to Adapt the Impact

- Water Resources

The following measures will be necessary: to improve prediction accuracy of run-off from rain and snow in river basin, to simulate impacts on hydropower, to clarify and simulate the impact of warming trend on water quality, to develop water utilization system of saving water, and to properly arrange and operate dam and reservoirs.

- Coastal Areas

The following measures will be necessary: to improve prediction accuracy and monitoring technology of sea level rise, to clarify erosion process of coast, and to improve technology on coastal maintenance facilities including artificial nourishment of coast.

c. Urban Infrastructure

Modification of design criteria of structures considering sea level rise and reexamination of design criteria or safety factors will be necessary.

3-11 IMPACTS ON INDUSTRIES (BY S. NISHIOKA, NATIONAL INSTITUTE  
FOR ENVIRONMENTAL STUDIES)

The word "industries" here means manufacturing and service industries except energy and transportation. Impacts on industries are caused by climatic changes through several stages, and are difficult to calculate strictly. At present, only a sensitivity analysis

is used in most cases.

- 1) The flow of influences on industries is as illustrated in Fig. 11-1. A change in demand affects almost all industries and restricts resources used in industries, regulating industrial locations and ultimately having an impact on international trade.
- 2) As shown in Fig. 11-2, there seems to be total indirect impacts between industries in addition to direct ones. Industries can be classified from the point of direct relations with climate as follows:
  - a. Climate-dependent industries include those which suffer a change in demand as exemplified by breweries and manufacturers of air conditioners. Influences are remarkable, but if warming progresses slowly, suppliers can adapt themselves to it.
  - b. Weather-dependent industries are civil works and construction which are mostly done outdoors. Periods of works are affected significantly. It is predicted that melting of ice will permit exploration for offshore resources in the Arctic regions.
  - c. Regional climate-dependent industries are mostly local industries, such as skiing ground operations, fermentation including beer and wine brewing, and textile manufacturing during snow season. Climatic changes are advantages to some areas while they are normally disadvantages to other area.

- d. Local resources-using industries are those using agricultural and forestry products and water resources produced in relation to climate. Influences are exerted on raw materials and utility. Relocation of production from region to region is anticipated.
  - e. Land resources-dependent industries are those which use land as tourist resources or coastal industries which have favorable site conditions. They will be considerably influenced by a rise in sea surface.
  - f. Change-dependent industries are those which are related to risk arising from a change in the world. A sweeping review is necessary concerning the insurance industry and development of infrastructures in many respects.
- 3) The magnitude of impact including direct ones can be measured from the following points of view.
- a. Influences on less adaptive local industries and regional influences ascribable to a rise in sea surface, advantageous or disadvantageous, cannot be overlooked.
  - b. Influences on industries in developing nations dependent on primary products processing are great.
  - c. Highly integrated systems exert an influence on each other in developed nations.
  - d. Ultimate influences combining local ones will amount to a considerable level.
  - e. A change in domestic and international trade patterns may cause a dispute in international politics.
- 4) Research themes in the future will include (1) promotion of studies of individual industries and regions, (2) grasping of a general influence, (3) analysis of influences on industrial location from the macroeconomic point of view, (4) investigation of influences on developing nations, (5) research on influences on international trade, (6) adaptability analysis of industries, and (7) establishment of an economic evaluation method.



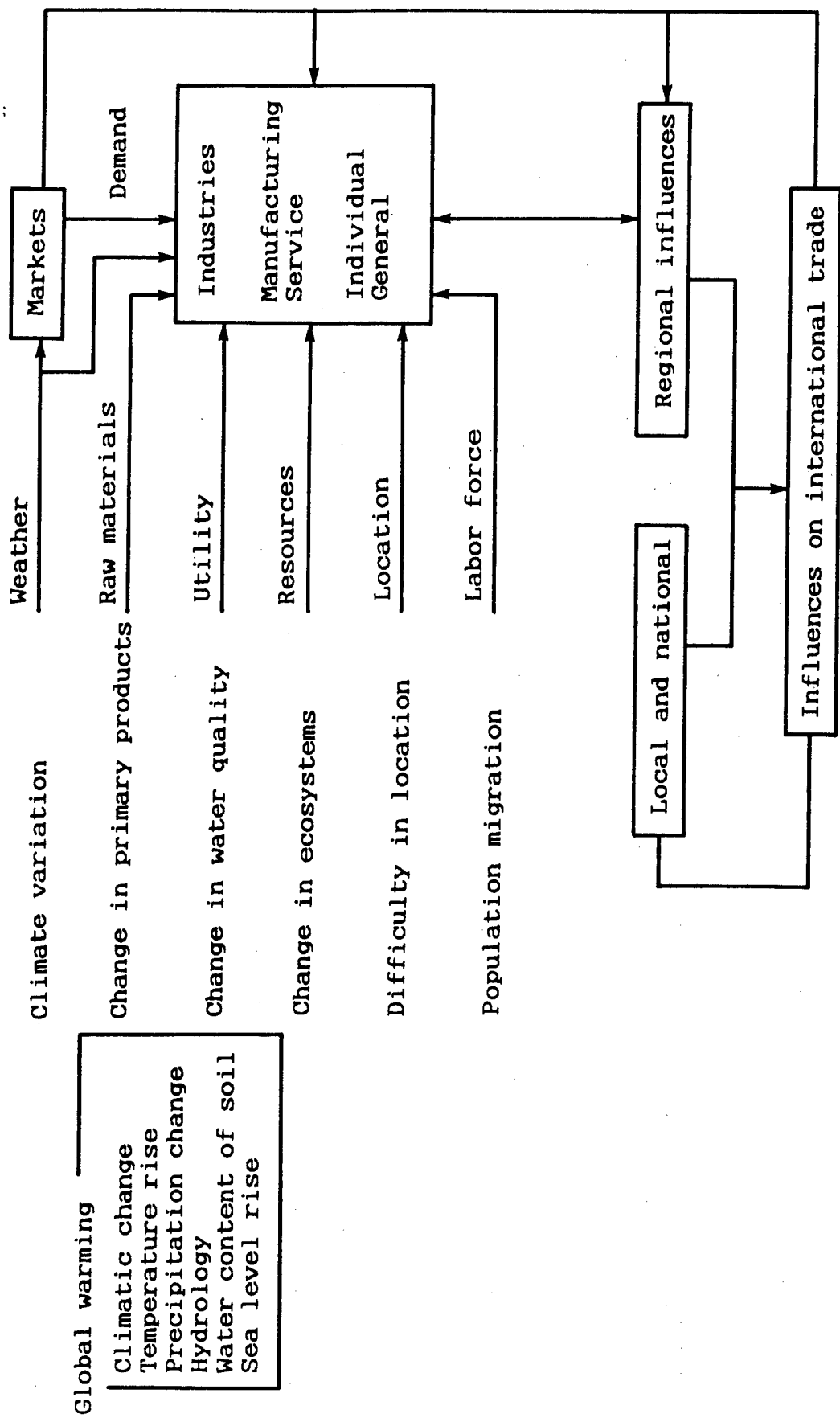

FIG. 11-1 INFLUENCES OF A CLIMATIC CHANGE ON INDUSTRIES

INDIRECT INFLUENCES

DIRECT INFLUENCES

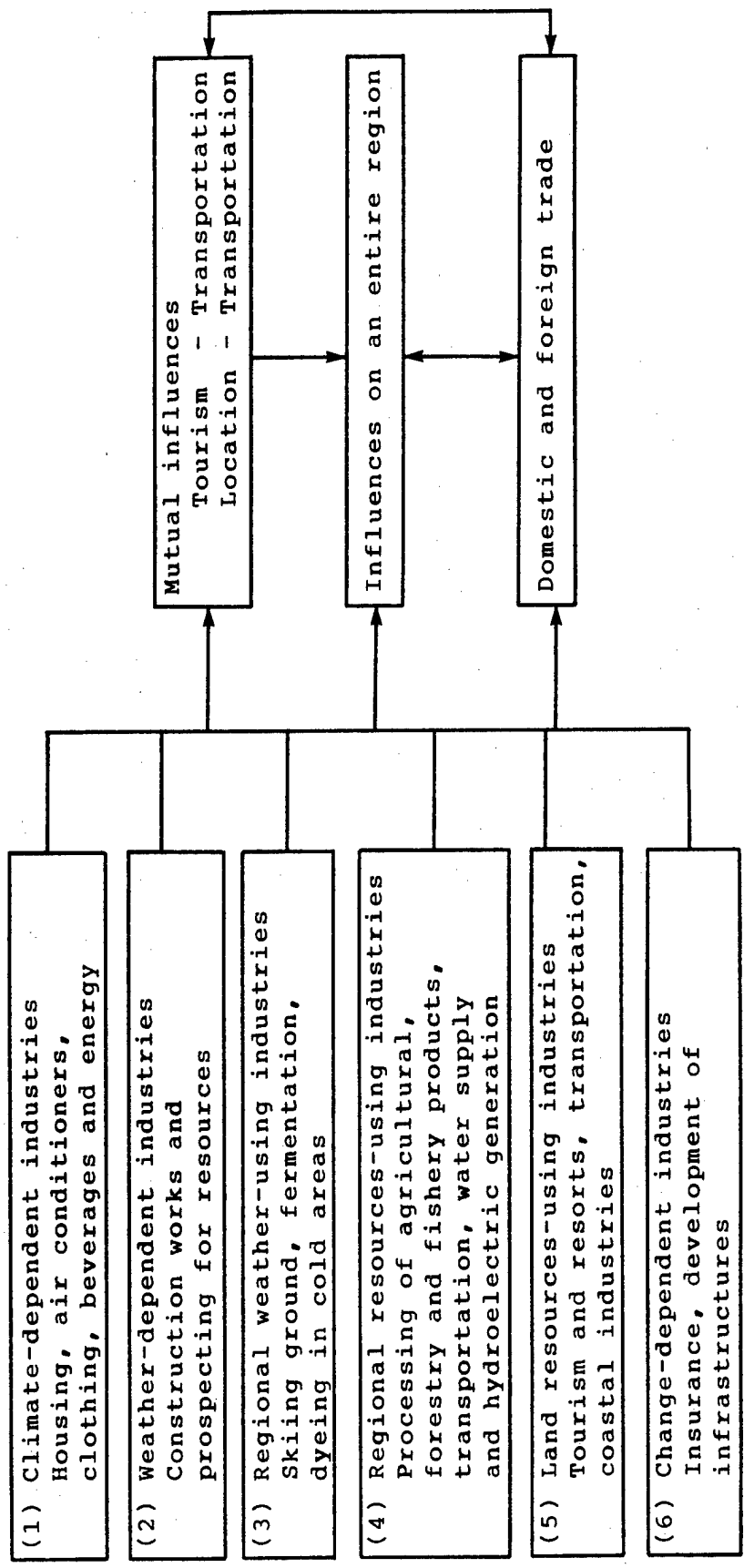

FIG. 11-2 IMPACT ON INDUSTRIES

### 3-12 INFLUENCE OF METEOROLOGICAL ENVIRONMENT ON HEALTH

(BY T. SASAKI, KUMAMOTO UNIVERSITY)

Changes in climate exert direct and indirect influences on human. The human body, however, responds to them by mobilizing its adaptability in such a manner to maintain homeostasis. As a result, a new status of morphological and functional stability is attained. The responses by the nervous system are generally quick in action and the effect is short in duration, while those by the endocrine system is slow but lasting. Among consideration of direct influences of a rise in ambient temperature, the question is whether the thermoregulation works well or not.

The input signal to drive the thermoregulation is thermal sensation. Sensation of "cold" is transmitted to the regulatory center mainly from the skin, and that of "warmth" is given by the blood temperature circulating through the hypothalamus, viscera and so on. These input signals are processed in the regulatory center, and the regulatory responses take place according to the thermal conditions of the body: heat production by an increase in metabolism or shivering, heat conservation by vasoconstriction and heat dissipation by vasodilation or sweating. In addition to these autonomic regulatory processes, the regulation is often accomplished by behavioral thermoregulation.

Thermal environments are characterized by many factors such as temperature, humidity, heat radiation, wind speed. In order to quantify the degree of heat and cold by a single index, a variety of indices have been introduced. Discomfort index was based on ambient temperature and humidity, which are principal factors of thermal conditions. By including the effect of radiative heat, WBGT (wet bulb globe thermometer index) was given. By paying due regard to wind speed besides temperature and humidity, effective temperature scale was obtained. In the heat, HSI (heat stress

index) and P4SR (predicted 4-hour sweat rate) were often used, which took sweating and work load into consideration, while in the cold, windchill index was applicable, which laid much stress on wind speed. The range of comfort zone changed with season and race.

Much is not known about the relationship between climate and health. As for indirect effect of climatic changes, for example, the relation between incidence of contagious diseases and their vectors has not practically been demonstrated yet. Studies on acclimatization during stay in resort area from different climatic conditions are under way, particularly in USSR and favorable results have been obtained for such a relatively short-term adaptive acclimatization. However, there are reports showing that the metabolic level of the non-indigenous population do not match with that of the indigenous population even after 10 years of migration. This suggests quite a long-term influence of climate, achieved through generations.

Human beings have been endowed with excellent adaptability to cold and especially to heat. They survived the glacial period and settled almost every corner on the earth by making efficient use of cultural adaptation (clothing and shelter), to say nothing of physiological one. Therefore I do not presume that a global rise in the ambient temperature by a few degrees will exert a considerable influence on the human body functions. The very problem is the influence on the balance of ecosystem, which is maintained among humans, animals, plants and microorganisms. Global warming may result in enlargement of tropical and subtropical zones. The habitat of animals, plants, insects and parasites will change, which is sure to affect our food and health. Thus, indirect and widespread influences may be, I fear, anticipated. Further studies are to be encouraged.

#### IV . SUBGROUP FOR RESPONSE STRATEGIES

##### 4-1 IMPACTS OF CARBON DIOXIDE EMISSION ON ENERGY SUPPLY AND DEMAND (BY T. SUZUKI, NAGOYA ECONOMICS UNIVERSITY)

###### 1) The Trend of World Energy Consumption

World energy Consumption increased at a rate of about 5 %/year average over a period of 5 years before oil crisis(1968-1973). Since 1973, the growth of energy consumption has been reduced to about 1.6%/year averaged over a decade after oil crisis, about one third of the earlier rate. The growth rate of energy consumption in the OECD countries sharply changed from 4.8%/year averaged over the 5 years, 1968-1973, to -0.2%/year a decade later.

The decrease in world demand for oil was 5.9 million tons from 1973 to 1983. This decrease during the period, 1973-1983, was composed of an decrease of 368 million tons in OECD countries, and an increase of 173 million tons in Centrally Planned Economies and 189 million tons in the developing countries, i.e., the decrease in oil consumption in OECD countries contributed to reduce shortage of supply in the oil market.

A projection of free world energy consumption is shown in Table 1-1, in which figures for the world are taken from the report published by Department of Energy in the USA in 1988; and figures of CPEs are based on energy plans and other information in these countries.

From 1973 to 1983, there have been improvements in the efficiency of energy use for the world as a whole. Energy consumption per GDP, the ratio of energy consumption to GDP, has been sharply reduced in North America ( USA and Canada ), China and Japan; and

slightly reduced in the OECD Europe. Energy consumption per GDP was increased in the USSR and East Europe; and increased slightly in the developing countries (GDP as defined in China is not suitable to compare with GDPs defined in the free world in terms of definition and the estimation methods. Index of energy consumption per GDP ( energy consumption per GDP normalized to 100 in 1973 )reached to the level of 85 in OECD countries in 1983.

## 2) The Trend of Carbon Dioxide Emission

The share of carbon Dioxide emissions for developing countries, as a percentage of total carbon dioxide emissions throughout the world, will increase by about 2% from 14.8% in 1988 to 16.8% in 2005; in CPEs by about 3% from 38.4% to 41.6% ; while that in the OECD will decrease by about 5% from 46.9% to 41.5%.

Carbon dioxide emission level in 2005 in the non-limitation case will be 1.7 times higher than the goal set up in the Tronto Meeting; in order to reach the goal, it will be necessary to cut carbon dioxide emission by 40% of total carbon Dioxide emission in non-limitation case in 2005. In particur, it will be necessary for developing countries to reduce carbon dioxide emission by 50% of their projected level in non-limitation case in 2005; and for CPEs by 47%.

Carbon dioxide emissions per energy consumption for principal OECD countries are about 0.7-0.8tons of carbon equivalent per tons of oil equivalent. Carbon dioxide emission per energy consumption for Canada and Sweden are less than 0.6 tons of carbon equivalent per tons of oil equivalent. This occurs because the share of non-fossil sources ( mainly hydro-power and nuclear ) is large in these countries. A high carbon dioxide emission per energy consumption for China, about 0.9 tons of carbon equivalent per tons of oil equivalent, relies on the large share of coal

combustion in energy use. Since 1973, carbon dioxide emission per energy consumption decreased at about 1%/year.

### 3) Carbon Dioxide Emission Limitation and Energy Economics

Three scenarios presented at the Intergovernmental Panel on Climate Change (IPCC) Conference assumes an increase in the temperature to a certain extent as unavoidable, projecting 2030, 2060, 2090 as years when the dioxide concentration reaches the Carbon Dioxide Equivalent Doubling level. The growth rates of carbon dioxide emission corresponding to each scenario are 3.5%/year, 0.8%/year, and -0.1%/year, respectively.

If the tendencies of decreasing energy consumption per GDP and carbon dioxide emission per energy consumption are the same as after the oil crisis, the growth rates for each scenario will be 5.6%/year, 2.8%/year, 2.0%/year, respectively.

### 4) The Impacts of Carbon Dioxide Emission Limitation on Energy Supply and Demand

In implementing the limitation of carbon dioxide emission as proposed at the Tronto Meeting, impacts of the carbon dioxide emission limitation on energy supply and demand are predicted as follows:

#### a. Effect of Partial Participation in Carbon Dioxide Emission Limitation Club

The Limitation of carbon dioxide emissions will produce different effects, varying with the participating country and region where such reduction is implemented. If only OECD countries implement such carbon dioxide emissions limitation, the effect is only about 34%, as a percentage of total required reduction of carbon emission worldwide. If only OECD and the USSR and East European countries, about 60%;

and if OECD countries and developing countries and China, about 75%. Then it should be noted, in particular, that participation of china and developing countries in such carbon dioxide emission limitation club produces an important effect.

b. Efficiency Improvement in Energy Use and Fuel Shifting as Measures for Carbon Dioxide Emission Limitation

In implementing the reduction of carbon dioxide emissions as proposed at the Tronto Meeting, it is assumed as the Base Case that one-half of the reduction is achieved by energy conservation and the other half by shifting in achieved by shifting in energy sources employed. Of the shift in energy source one-half is assumed to be achieved by shifting from coal and liquid fuels to natural gas and the other half by shifting from coal and liquid fuels to non-fossil sources such as renewable energy sources and nuclear energy. Carbon dioxide emission level in 2005 in this case will be 1.2 times higher than in 1988. The change in the energy mix is so drastic that it is not realistic from the energy economics stand-point, and a problem with resources in terms of reserves, production and prices is expected to emerge.

The expansion of the present plan, assuming that it will be difficult to revise upward the present plan for nuclear power development before 2005. In the case of Maintaining the Status Quo of Nuclear Power Development, it is assumed that the shift in energy sources is achieved entirely by shifting coal and liquid fuels to natural gas. In this case, the carbon dioxide emission level in 2005 will be 1.3 times higher than in 1988. The impact of carbon dioxide emission limitation in the case of Maintaining the Status Quo of Nuclear Power Development will be more severe than in the Base Case.



Table 1-1 Energy Supply and Demand in 1988 and 2005

[ unit : EJ ]

Region/Nation	Coal	Liquid Fuel	Gas	Nuclear	Hydro-power	Total Energy Supply/Demand
1988 :	34.0	78.1	27.7	16.0	17.3	173.1
OECD Countries	10.0	26.6	7.4	0.9	6.3	50.9
Developing Countries						
Centrally Planned Economies	54.0	28.5	27.8	8.0	15.9	134.2
China	23.2	4.6	0.5	0	5.6	33.9
USSR	16.0	18.5	23.1	6.1	7.3	71.0
East Europe	14.8	5.4	4.2	1.9	3.0	29.3
2005 :						
OECD Countries	52.2	80.0	38.5	20.0	31.0	221.7
Developing Countries	16.2	38.9	15.1	2.3	10.7	83.2
Centrally Planned Economies	84.1	33.3	50.9	23.9	34.9	227.1
China	47.2	7.5	1.9	0.9	15.3	72.8
USSR	19.3	20.1	42.3	12.9	6.9	101.5
East Europe	17.6	5.7	6.7	10.1	12.7	52.8

Notes: Figures of free world are taken from the report published by Department of Energy in USA in 1988 ; and figures of CPEs are based on energy plans and other information in these countries.

CO<sub>2</sub>/Energy (g-C/Ntoe)

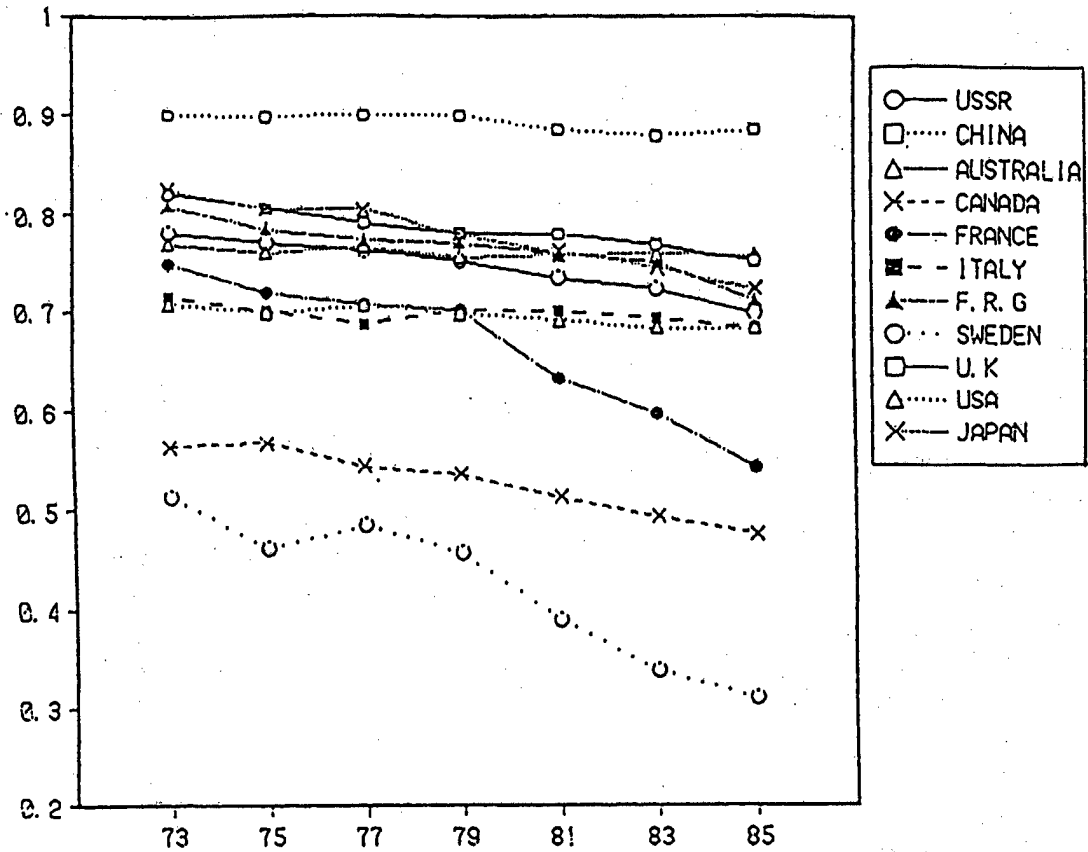

Fig.1-1 Trends of Carbon Dioxide Emission per Energy Consumption  
CO<sub>2</sub>/Energy(t-C/toe)

4-2 ULTRA LONG TERM ENERGY SCENARIOS (BY K. YAMAJI, CENTRAL  
RESEARCH INSTITUTE OF ELECTRIC POWER INDUSTRY)

Ultra long term energy scenarios give an outlook on energy supply and demand over a much longer period than conventional long term scenarios. The latter generally span energy investments over a decade. Many factors such as future technological innovations need to be considered in ultra long term scenarios. Thus, ultra long energy scenarios have a wider range of forecasted results. However, this is not to say that either type of scenario is incorrect. Traditionally, scenarios are not used as a forecasting tool but were established in order to assess a situation which might possibly exist in the future if new restricted conditions are set. This is why energy scenarios which are widely divergent should be used so that a wide range of future options can be evaluated.

There are mainly two routes by which scenarios can be analyzed, these are the Forecast and the Backcast types. The forecast type analyzes the scenario using a model with input assumptions. This type includes those which simulate energy supply and demand within the market and which optimize the energy system.

The Backcast type analyzes the key factors involved in constructing the target scenario. In order to analyze the energy strategy needed to cope with greenhouse gases, it is necessary to adopt a global approach. However, it is difficult to consider a specific region and the entire world simultaneously. Thus, it seems more appropriate to integrate the calculations of each of the regional/national scenarios using common assumptions. The techniques which have been used to simulate energy supply and demand in the market are as follows:

- 1) Edmonds-Reilly (IEA/ORAU) model: It has largely been used to examine the CO<sub>2</sub> problem and to estimate the likely effect of an energy usage taxation rate. It divides the world into 9 regions. It establishes the premise conditions for each region and provides the supply and demand lines. Then the energy balance until 2100 is calculated. However, it can not show minute time changes because the energy balance of supply and demand is calculated only every 25 years.
- 2) Nordhaus-Yohe model: This model considers only one global region. The energy classification is in terms of fossil and non-fossil fuels. Sensitivity of the parameters used is analysed through a probabilistic simulation.
- 3) World energy supply and demand model. ( CRIEPI, IEE) The main purpose of this model is to forecast the price of oil.

The models which optimize the energy system are as follows:

- 1) IIASA model: The world is divided into 7 regions by combining the demand model, supply model, the optimization and impact models together. The methodologies and data are well established in this energy system analysis which deals with the whole world. However, it has been criticized because it does not deal sufficiently with energy saving technology.
- 2) MARKAL model: this has been developed by IEA/OECD and can be applied to one nation or region. Theoretically it includes all the forms of energy use technology and indeed is largely used to assess the effect of energy technology.

The Backcast type of scenario analysis include the following:

- 1) Goldenberg et al:

Research carried out in the USA and Sweden conclude that developed countries will be able to attain energy savings. The energy efficiency of the developing countries in 2020 is expected to be similar to the European level in 1970's, if use is made of the best available energy use technology. The

economic activity of developed countries will double, while the energy demand of the developing countries will be the same as now.

2) Lovins et al :

This model uses two basic trends that of population and economic growth from the lowest growth scenario of the IIASA's model. Research carried out in West Germany shows from these theoretical results that a 70% reduction in energy use can be attained worldwide, with renewable energy sources playing a major role in the supply of energy. This scenario also predicts that energy usage and CO<sub>2</sub> emissions will be largely reduced.

3) DEM-parametric (CRIEPI)

This has been used to forecast energy supply and demand up to 2030. The model has also been combined with a generation mix optimization model.

Current scenario analyses are not specialized enough to deal with energy using technology. The factors which need to be more fully evaluated in the future are:

1) Energy demand:

- a. The growth in population and economical activity ,and the type of policy measures adopted (taxation, etc.)
- b. Effective control of energy supply and demand (power, heat, temperature, light, etc.)
- c. The extent to which the use of energy technology has been introduced into the market and it's price, etc.
- d. The energy demand curve (changes in the quality, price, time and region)

2) Energy supply:

- a. Resource restriction and technical improvements (time re-

quired for the practical use of nuclear fusion etc.) Policy measure (R/D in investment etc.)

- b. The characteristics of energy conversion technology (effectiveness, price, etc.)
- c. Restrictions (the penetration and speed of new technology into the market, environmental restrictions, rate of dependency upon imports, etc.)
- d. The energy supply curve (changes in the quantity, price, time and region)

3) Uncertainties and freedom of choice:

- a. Choice in the method used in the scenario analysis
- b. The setting up of the inputs used in the case study
- c. Probabilistic simulation and the sensitivity of parameters used.

4-3 INTERPRETATION OF CO<sub>2</sub> CONTROL SCENARIOS (BY Y. KAYA,  
UNIVERSITY OF TOKYO

The relation between control of CO<sub>2</sub> emission and achievable economic growth is simply analyzed in formulas (1) and (2). These formulas help to understand the meaning of the control scenario of CO<sub>2</sub> emission shown in EPA report.

$$C = X \cdot Y \cdot Z \dots\dots\dots(1)$$

- C : Amount of CO<sub>2</sub> emission (C-ton)
- X : Energy / GNP (Oil equivalent ton / US\$)
- Y : C / Energy (C-ton / Oil equivalent ton)
- Z : GNP (US\$)

$$dC/C = dX/X + dY/Y + dZ/Z \dots\dots\dots(2)$$

CO<sub>2</sub> emission is expressed as a product of these three factors energy efficiency (X), carbon intensity of energy supply (Y), and gross national product (Z) in formula (1). Formula (2) derived of formula (1) shows that the sum of change rate of these three factors is equal to the change rate of CO<sub>2</sub> emission.

Fig. 3-1 shows the past trends of energy efficiency (X) in OECD countries. Each country has some improvement. The average rate of improvement in U.S.A. from 1920 to 1985 is about 1% and more improvement has been attained in developing countries. Taking the above fact into account we assume that X of the world will be improved by 1.2% before 2040, and 0.6% after 2040. (In 2090, 60% reduction in Y, when compared with present value, is expected. This value well corresponds to the value estimated by Brookheaven national laboratory.)

Fig. 3-2 shows the past trends of carbon intensity of energy supply. The value shows steady but slow decrease in most countries. It is low in France because of high share of nuclear and also in Sweden because of nuclear energy and hydro power. We here assume that its value of the world will reach the medium

value between those of France and OECD countries (0.61). It means that Y will be improved by 0.3% annually.

In EPA report, the annual rate of increase of CO<sub>2</sub> emission is supposed to change by time. For simplicity we assume that CO<sub>2</sub> emission will increase. It is supposed to be fixed owing in a fixed rate with time. In case of 2090 CO<sub>2</sub> equivalent doubling scenario corresponding rate of charge of CO<sub>2</sub> emission is 0.1% a year.

Table 3-1 shows the results of achievable economic growth rate calculated from the above assumptions. At present, the average rate of growth is 3% in OECD countries. The above table shows that average rate of growth will be 1.6% and after 2040 it will fall to 1.0% in 2090 CO<sub>2</sub> equivalent doubling scenario. Furthermore, if we admit the observation that the income elasticity of energy is relatively high far lower economic growth, the achievable economical growth rate is expected to be much lower than these values. It is also to be noted that GNP per capita will experience negative growth, as the population will grow at a rate of 1-2%/year even in the next century.

To avoid negative impacts of controlling CO<sub>2</sub> emission on the world economy, it is essential to improve both X and Y; i.e. by the substantial improvement of energy efficiency and switching from fossil fuel to non-fossil fuels.



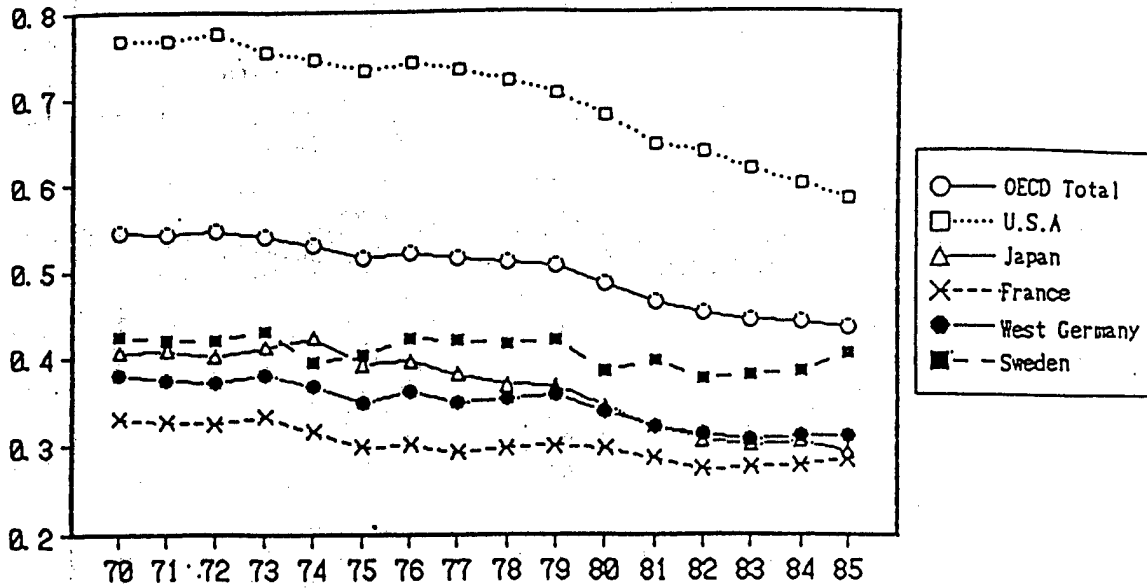

Fig. 3-1 Past Trends of Energy/GNP (Energy Efficiency) in OECD Countries

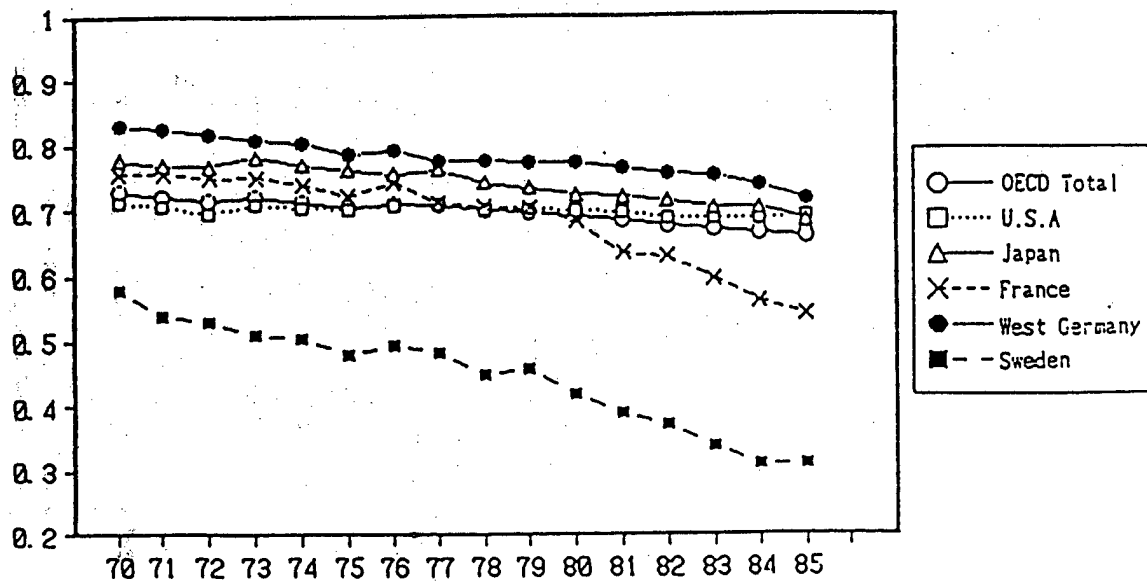

Fig. 3-2 Secular Change of CO2/Energy (Rate of Energy Concentration to Fossil Fuel) in OECD Countries

Table 3-1 Growth Rate Forecast

Scenario Case	CO <sub>2</sub> Emission Increase	C/E	E/GNP	Achievable Growth Rate of GNP	Income ** Elasticity of Energy
2030 doubling (CO <sub>2</sub> equivalent)	1.7% /year	-0.3% /year	-1.2% /year (by 2040)	3.2(by 2040) 2.6(after 2040)	0.625 0.77
2060 doubling (CO <sub>2</sub> equivalent)	0.5% /year	- do -	-0.6% /year (after 2040)	2.0(by 2040) 1.4(after 2040)	0.40 0.57
2090 doubling (CO <sub>2</sub> equivalent)	0.1% /year	- do -	(after 2040)	1.6(by 2040) 1.0(after 2040)	0.25 0.40
Values in 2090		0.61*	0.40 of E/GNP in 1990		

1) Constant CO<sub>2</sub> emission growth is assumed.

2) Total emission CO<sub>2</sub> by the target year is given by the EPA scenarios.

\* The value of OECD in 1985 is about 0.7 and that of France in 1985 is 0.54.

\*\* Income elasticity of energy= $I+X'/G'$  where X' and G' are yearly rates of change of X and G respectively.

#### 4-4 TRACE GASES WHICH AFFECT GLOBAL WARMING AND PREVENTIVE COUNTERMEASURES (BY H. AKIMOTO, NATIONAL INSTITUTE FOR ENVIRONMENTAL STUDIES)

Atmospheric trace constituents which affect global warming may be divided into three groups, as shown in Table 4-1. They are (1) radiative gases (2) relevant warming gases (3) substances related to aerosols. The substances in each of these categories affect global warming in a different way.

Some of these trace gases are involved in the atmospheric reactions depicted in Fig. 4-1. For example, methane or HCFC, which are in themselves greenhouse gases can form another radiative gases which can then contribute to the formation of tropospheric ozone by an atmospheric radical reaction in the presence of NO<sub>x</sub>. They are also related to the new generation of photochemical aerosols which may effect the heat balance of the earth. The atmospheric lifetimes of methane, HCFC and HFC are controlled by their reaction with OH radicals. Thus, if the intensity of CO emissions increases, the concentration of methane may increase because of the competitive consumption of OH by CO, even if the emission intensity of methane alone does not increase. Therefore, it is necessary to consider such reactions in order to be able to predict the concentrations of these trace gases more accurately.

The change in concentration of the trace gases will have a much greater effect on global warming than that of CO<sub>2</sub> alone, if the changes in concentration are the same. For example, it has been approximately estimated that the global warming effect of CH<sub>4</sub>, N<sub>2</sub>O, O<sub>3</sub> and CFC are in the order of 10, 100, 1000, 10,000 times larger than that of CO<sub>2</sub> respectively in the same concentration. As for the relationship between an increase in concentration and the warming effect, CO<sub>2</sub> contributes logarithmically, whereas N<sub>2</sub>O

and methane show an approximate square root dependence on the concentration increase, the other trace gases exhibit a linear relationship.

Therefore, changes in the concentration of trace gases are considered to have a greater effect on warming despite their lower concentration than CO<sub>2</sub>. For example, the accumulated contribution to global warming by CO<sub>2</sub> and other gases is now estimated to be about 2:1. The contribution of trace gases will exceed that of CO<sub>2</sub> by the 2020's, and the ratio of the accumulated contribution will be approximately 1:1 until 2029.

Control of these trace gases is one of the countermeasures available against global warming. It is necessary to obtain the following fundamental information before planning the appropriate countermeasures.

- 1) Specification of the natural and anthropogenic sources of trace gases in Japan.
- 2) Quantitative estimates of the emission strengths from each of the sources and investigations for improving the accuracy of such estimates.
- 3) The contribution of the emissions to the world total from Japan, as well as from Asia and the Pacific Area.

Each trace gas is unique when considering the appropriate countermeasures for each of them. Furthermore, it is necessary to take action in order to solve each of these specific problems.

1) Methane:

The major problem with methane is that the cause of the increase in its concentration has not yet been established, such investigations are urgently needed. An example of the estimated emission intensity of methane from various sources is shown in Table 4-1. The following possible actions for limiting its emissions from anthropogenic source may be

considered:

- a. Control of emissions in the extraction, transport and use of natural gas.
- b. Control of emissions from land-fill sites.
- c. The possible control of emissions by improving rice cultivation methods and livestock management.
- d. Control of emissions from biomass burning. Minimizing the emission of methane from natural gas usage is important, because a further change in fuel usage from coal and petroleum to natural gas is anticipated in future. It is also necessary to pursue the possibility of controlling the other sources in order to minimize the total quantity emitted.

2) N<sub>2</sub>O:

The cause of the increase in the concentration of N<sub>2</sub>O has not been fully investigated. An example of the estimated emission intensity from the various sources of N<sub>2</sub>O is shown in Table 4-2. The following actions for limiting it's emissions may be considered:

- a. Control of emissions from fossil fuel burning.
- b. Control of emissions from the soil which arise as a result of using nitrogen fertilizer. A control for decreasing the source of this emission of N<sub>2</sub>O has been proposed by the addition of a nitrification inhibitor.

3) Chlorofluorocarbons and their substitutes

A control in the production of selected chlorofluorocarbons has been introduced as a countermeasure to protect stratospheric ozone. A control such as this is also effective in limiting global warming. However, the substitutes for chlorofluorocarbons now being considered also have radiative properties and a long stratospheric residence time. Thus, it is important to consider countermeasures to prevent the accumulation of these gases by controlling their total emitted.

#### 4) Tropospheric ozone

Ozone is a photochemical secondary product, it is important to control the emissions of its precursors-nitrogen oxides, non-methane hydrocarbons, etc. Such countermeasures would be essentially similar to the existing countermeasures which are used to prevent photochemical smog. However, the formation mechanism of tropospheric ozone within the Asian and Pacific Area has not yet been established and such investigations are urgently needed.

Table 4-1 Atmospheric trace substances related to global warming

A) Radiative gases (Gases which have a direct effect of warming)

- 1) Methane ( $\text{CH}_4$ )
- 2) Nitrous oxide ( $\text{N}_2\text{O}$ )
- 3) Chlorofluorocarbon (CFC)
- 4) Hydrochlorofluorocarbon (HCFC), Hydrofluorocarbon (HFC)
- 5) Tropospheric ozone ( $\text{O}_3$ )

B) Gases relevant to warming (Precursors of ozone, gases which affect the concentration of methane and HCFC)

- 1) Nitrogen oxides ( $\text{NO}_x$ )
- 2) Non-methane hydrocarbon (NMHC)
- 3) Carbon monoxide ( $\text{CO}$ )

C) Substances related to aerosols (Substances which affect the heat balance of the earth)

- 1) Black carbon
- 2) Substances ejected from volcanoes
- 3) Sulfur dioxide, other sulfur compounds

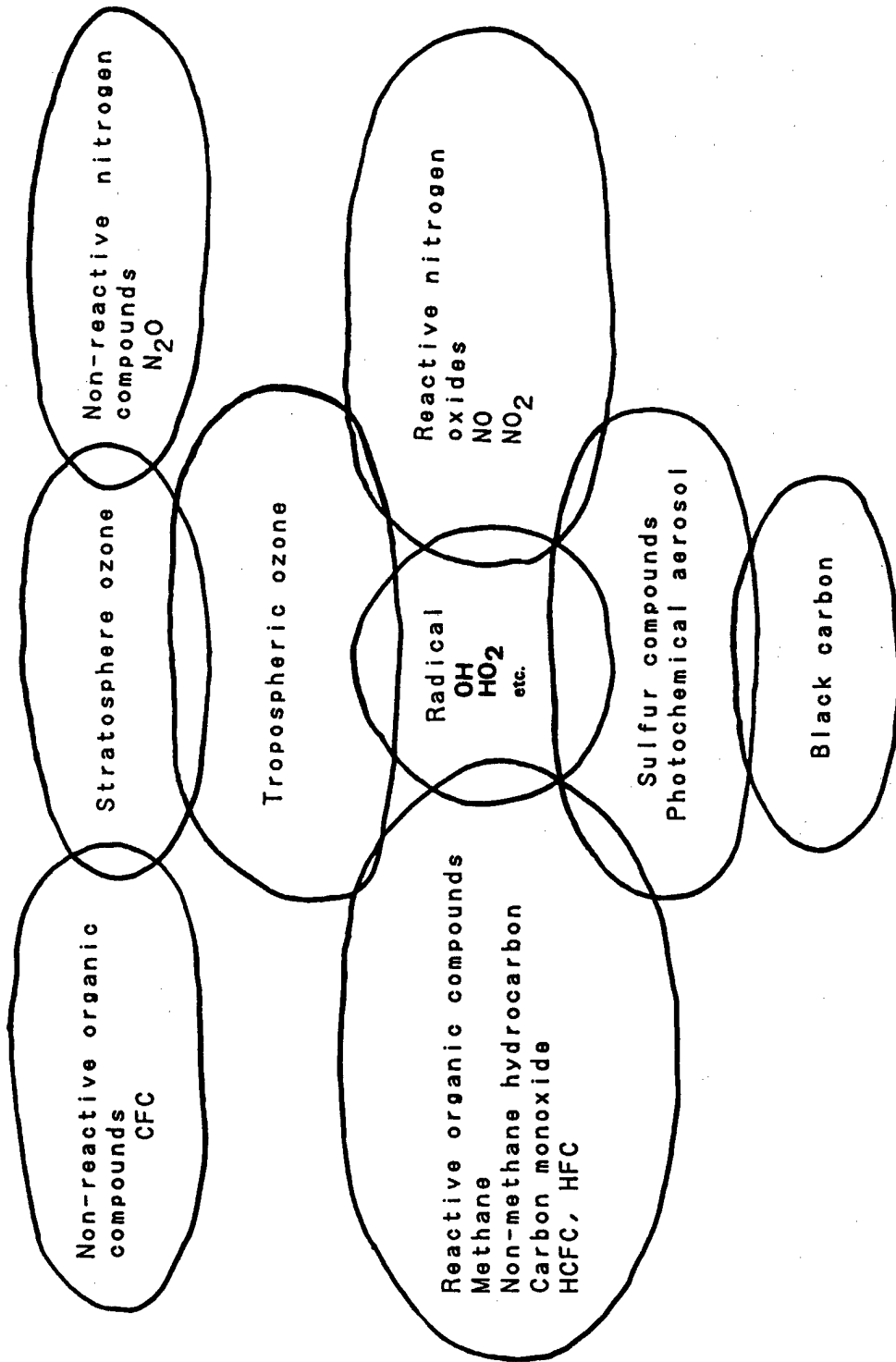

Figure 4-1 Correlation between trace gases affecting global warming  
( Radiative trace substances )



Table 4-2 Emission intensity of the various sources of methane (\*)

-----	
Natural sources (Mt/yr)	
Enteric fermentation (Wild animals)	5(± 3)
Wetlands	110(±50)
Lakes	4(± 2)
Tundra	3(± 2)
Ocean	10(± 3)
Termites	25(±20)
Others	40(±40)
Sub-total	197
Anthropogenic sources (Mt/yr)	
Enteric fermentation (Livestock)	75(±35)
Rice paddies	70(±30)
Biomass burning	70(±40)
Natural gas and mining losses	50(±25)
Solid waste landfill	30(±30)
Sub-total	295
Total	492

(\*) From a report by the Department of Energy, USA  
 "A Primer on Greenhouse Gases" (1988.3)

Table 4-3 Emission intensity of N<sub>2</sub>O from various sources (\*)

-----  
 Natural sources (Mt-N/yr)

Ocean	2.5(+1.0)
Natural soil	6.5(+3.5)
Sub-total	8.5

Anthropogenic sources (Mt-N/yr)

Fossil fuel burning	4.0(+1.0)
Biomass burning	0.7(+0.2)
Fertilized soil	0.8(+0.2)
Cultivated natural soil	1.5(+0.5)
Sub-total	7.0
Total	15.5

-----  
 (\*)From a Report by the Department of Energy, USA  
 "A Primer on Greenhouse Gases" (1988.3)

4-5 THE EFFECT OF GLOBAL WARMING ON AGRICULTURE AND  
COUNTERMEASURES FOR AGRICULTURE (BY T. UDAGAWA, MINISTRY OF  
AGRICULTURE, FORESTRY AND FISHERY)

1) The impact of global warming on agriculture:

An increase in the concentration of CO<sub>2</sub> has both advantages and disadvantages for the the growing of crops as illustrated in Fig. 5-1. The advantages include an increase in photosynthesis, an extended growing period, the expansion of land suitable for growing crops and decreased rates of transpiration.

However, the disadvantages include an increase in weeds, changes in soil moisture by the rise of atmospheric temperature, decrease in the amount of organic matter in the soil which is produced from the activity of microorganisms, an increase in pests, the submergence of low lying arable land caused by a rise in sea level.

Likewise, the effect on livestock has both advantages and disadvantages. This is because the growth of livestock is affected by forage. Also, a rise in atmospheric temperature decreases the amount of milk produced by cows as well as decreasing the rate at which beef cattle increase in weight.

It is expected that the rise in temperature will cause the expansion of land suitable for growing crops and increase the amount of growth. However, this should not imply that the harvest will necessarily increase and the existing systems of culture techniques may have to be adapted. For example, it may be necessary to select and grow more suitable cultivars or to improve the culture techniques.

Table 5-1 shows a summary of 18 reports covering each country

of the world by Smit et al. Many of them predict a decrease in the amount harvested around the middle latitudes and an increase in the harvest for the high latitudes. Reports for low latitudes areas, especially relevant for the developing countries, are very few and it is necessary to study the impact on agriculture on such countries.

## 2) Agricultural impact on global warming

CO<sub>2</sub>, methane and nitrous oxide are considered as the greenhouse gases produced from agriculture. Firstly, considering the emissions of CO<sub>2</sub>, the amount of fossil fuels used in agriculture and forestry are relatively small, it is responsible for about 1% of the total demand in Japan. However, the amount of wood and vegetation which absorb CO<sub>2</sub> is decreasing because forests are being felled and land burnt in order to develop agricultural land in developing countries. This is the largest problem area with respect to CO<sub>2</sub> emissions.

Secondly, considering the sources of methane in agriculture, it has been estimated that livestock produce 14-30% of the total. However, such data has not been well established yet. The emissions from swamps is more per unit area than from rice fields. The emissions from rice fields is estimated at a lower figure of 14%. Calculations made using the latest data on the emissions of methane emitted per unit area, give a total of about 20g/m<sup>2</sup> year. Emissions from rice fields are considered to be fairly simple to control by changing the organic fertilization method or by means of water management control. The emissions of methane from herbivorous livestock is caused by intestinal and ruminal fermentation, such emissions may be able to be controlled by the addition of additives in their feedlot.

The emissions of nitrous oxide from arable fields consumes

0.2-0.4% of the nitrogen fertilizer used. This is produced from the process in which  $\text{NH}_4\text{-N}$  fertilizer is oxidized into  $\text{NO}_3\text{-N}$  by microorganisms. This reaction can be controlled by adding nitrification inhibitors or slowly acting fertilizer. Emissions of nitrous oxide from fertilized soil is responsible for 5% of the total.

### 3) Future problems

Problems which need to be studied in the future are as follows:

- a. Examination of the effects of global warming on the agro - and forest ecosystems.
  - Adaptations to the physiology of crops under high  $\text{CO}_2$  concentrations and high temperature.
  - Changes in the soil environment.
  - Changes in pest generation.
  - An estimation of the compounded effects of warming, increase in ultraviolet rays, and acid rain.
  
- b. Examination of the effect of agricultural and forestry production on global warming.
  - Development of agricultural land by felling forests and changes in the greenhouse gases.
  - Examination of the greenhouse trace gases and their emissions from the agro - and forest ecosystems.
  
- c. Establishment of techniques to control the effects of agricultural and forestry production processes on global warming.

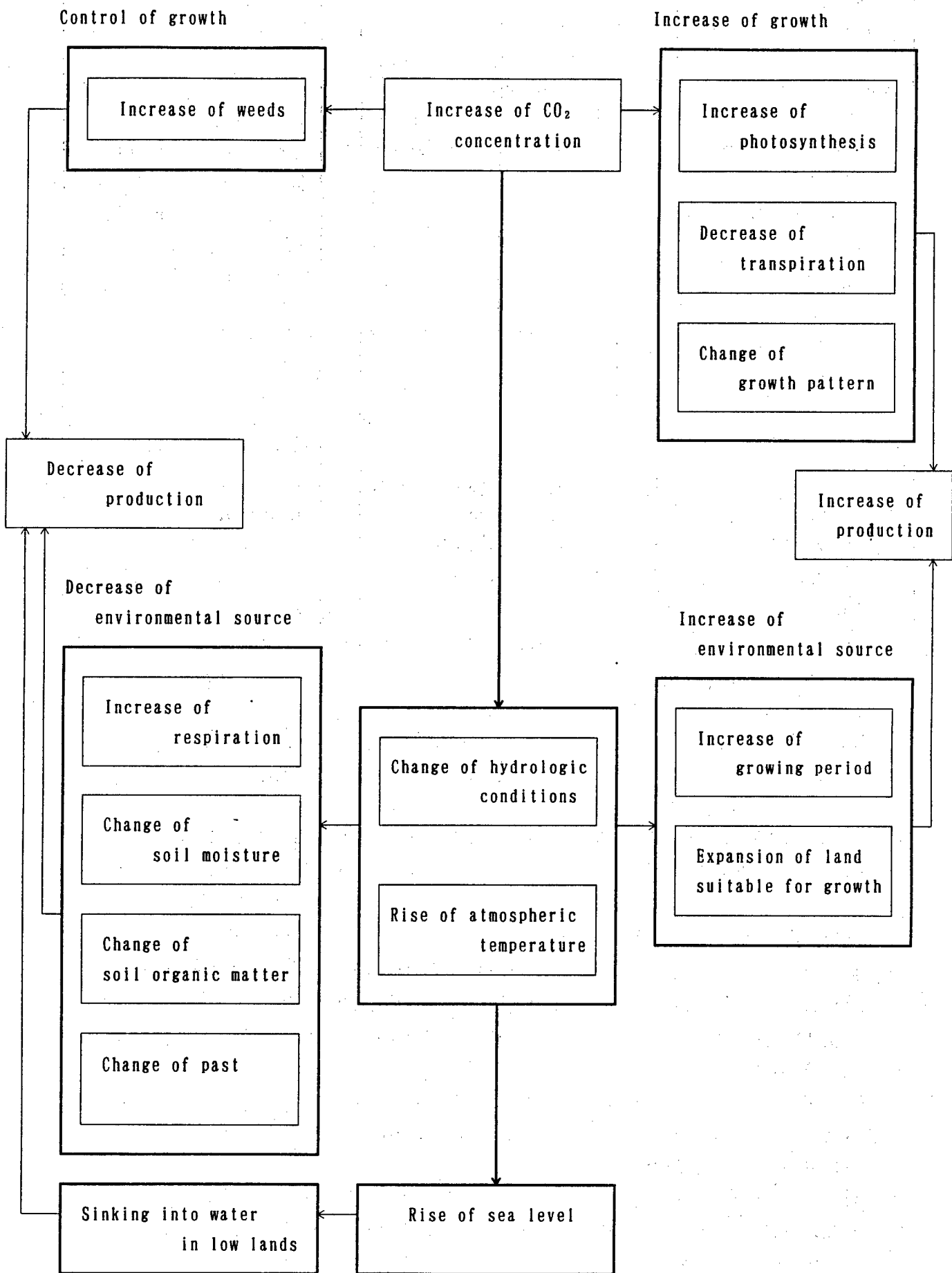

Figure 5-1 Increase of CO<sub>2</sub> concentration and production of crops

Table 5-1 Impact of global climate change on agriculture (Smit, Betal, 1988)

Student	Scenario of climate change				Area	Crop	Main point of the result
	Model	$\Delta t$	$\Delta P$	Others			
1. Benti et al. 1975	Inc.	+1°	+10%	No	Center and west America	corn	Harvest decreases 10-20%
2. Blashing & Solomon 1984	GCM	+3°	+20%	Yes	Center and West America	corn	The Cornbelt moves to north-east (Maybe Ontario)
3. Bootsma et al., 1984	Inc.	Yes	Yes	No	Canada	corn, feed, potato, grain oils and fats	Harvest decreases in most part of Canada.
4. Bergthorsson et al., 1988	GCM	+4°	+15%	Yes	Iceland	hay, posturage	Harvest of hay increases 60%. Pastueyield increases 49-52%. The carrying capacity of apsturage rises.
5. Kettunen et al. 1988	GCM	+33%	+50%	Yes	Finland	spring wheat, barley, oats	Harvest of spring wheat, barley, and oat, increase 20%, 14%, and 13% each. Income of farmer increases 12-27%
6. Pitovranov et al., 1988	GCM	+2.2°	+36%	Yes	USSR	rye, spring wheat	Harvest of rye and spring wheat increase 6% and 3% each. (Non-improvement Harvest of rye and spring wheat increase 50-57% and 16-26% each. (Improvement Harvest of wheat and corn increase 30% and 10% each. Others have no increase Product of wheat and corn increase. Other decrease.
	Inc.	+1°	No	No	"	wheat, barley, oats, corn, potato etc.	
7. Williams et al., 1988	GCM	+3.5°	+0%	Yes	Saskatchewan in Canada	wheat	Harvest decreases 4-29%. Product of whole state decreases 15%. Income of farmer decreases 7%. Employ decreases 0.8%.
		+3.6°	+19%				
8. Ycshino et al., 1988	GCM	+3.5°	No	Yes	Japan	rice plant, NPP	Harvest of rice plant increases 2-5%. Progress of growth limit. Product of rice plant and NPP increase 3% and 9% each.
9. Land Evaluation Group 1985, 86	GCM	Yes	Yes	Yes	Ontario in Canada	corn, barley, oats, wheat, soy bean, hay, soiling corn, potato again	Harvest decreases except in north area and east area. Product of crops of whole state decreases.
10. Liverman, 1986	Hypothetical				world		Rapid change decreases harvest both in local area and in all over the world. Slow change doesn't have much impact. Harvest of most crop decrease.
11. Lough et al., 1983	HA	Yes	Yes		Wales, England	wheat, barley, oats, hay etc.	
12. Nat. Defence Univ., 1978, 1980, 83	EO	Yes	Yes	No	world	again	Harvest of almost all over the world decreases. Exception is the increase of wheat in USSR and Canada. Product decreases in Africa, Australia, Central America, India, USA, Weatern Europe. Product increases in Argentina, Canada, China, Eastern Europe, USSR.
13. Neuman, 1980	Inc.	+1°	No	No	Center and west America	grain, corn	Corn belt moves to north 144 km and to east 100 km, by 1°C rise of temperature
14. Ramirez et al., 1975	Inc.	+1°	+10%	No	Center and west America	wheat	Harvest decreases 13-20% (dry area-Illinois, Indiana). Harvest increases 10% (wet area-Kansas, North Dakota)
		+2°	+20%				
			+30%				
15. Rosenzweig et al., 1985	GCM	Yes	Yes	Yes	Canada, America, Mexico	wheat	Fall wheat area extends in Canada. No change in America. Harvest decreases by high temperature in Mexico.
16. Santer, 1985	GCM	Yes	Yes	Yes	Western Europe	wheat	Harvest decreases in main producing countries, France, German, Italy etc.
17. Terjung et al., 1984	Inc.	+1°	No	No	world	corn, rice plant, wheat	Harvest of all decreases and the maximum decrease is 8%.
18. Waggoner, 1983	Inc.	+1°	-10%	No	Center and west America	wheat, soy bean	Harvest of all decreases 10%.

Notes)  $\Delta t$ ,  $\Delta P$ : the change of temperature and precipitation. GCM: aomospheric cycle model.  
Inc.: incremental. HA: according to data in the past. EO: opinion of experts.

4-6 ENERGY SAVING IN MOTOR CARS (BY Y. SHIDOU, JAPAN MANUFACTURERS ASSOCIATION INC.)

Improvement in the fuel economy of a car is a significant and attractive selling point. A great deal of effort has been made to achieve this from a variety of diverse technological fields. For example, improvements in the fuel economy and measures taken to control exhaust emissions which exhibit a trade-off relationship, as illustrated in Figs. 6-1 to 6-3.

a. Measures taken for engines only:

An increase in the combustion efficiency through improvements in the combustion chamber, reduction of other losses etc.

b. Reduction of acceleration resistance:

A decrease in the weight of the vehicle, etc.

c. Reduction of running resistance:

A reduction in the rolling resistance has been achieved through the adoption of radial tires and improvements in the wheel bearing. Reductions in air resistance have been obtained

through improvements in the body styling, etc.

Throughout the world there is a high and widespread use of technologies contributing to the improvement in fuel economy. For example, more than half of the sales units are equipped with multi-valve engines and more than 90% of these are controlled by injection.

As a result, the fuel consumption per car is tending to decrease. However, the ownership of gasoline-fueled cars and the amount of fuel consumed tends to increase year after year. Also, the average fuel economy of all kinds of cars (CAFE) has risen from 9 Km/l in 1975 to 13 Km/l in 1983. The fuel economy of Japanese domestic cars is more efficient than foreign made cars when comparisons are made between the same types of vehicle, as illustrated in Figure 6-4.



However, in terms of the market environment, despite a strong users' demand for fuel efficiency, the number of large-sized cars has increased as is reflected by the users' trend towards luxury cars. The installation rate of power steering, cars with automatic transmission and the ownership of four-wheel-drive cars have increased showing that improvements in operation performance and full safety equipment are also desired, despite such features decreasing the fuel efficiency. The corporate average fuel economy fell to 12.4 Km/l in 1985, and thus further improvements in fuel economy have been stagnated.

Furthermore, the annual change in the rate of minimum fuel economy, an indication of the fuel economy performance of an engine shows no fluctuations, which indicates that improvements of fuel economy from within the engine alone have almost reached it's limit. Thus, with this in mind, further technological developments which need important consideration are as follows:

a. Weight reduction of a vehicle:

Utilization of resin and light alloy materials, development of structure analysis technology, etc.

b. Spread of electronic control technology:

Electronic control of fuel injection, comprehensive control of vehicles, etc.

c. Enhancement of the various kinds of efficiency:

Improvements in the combustion efficiency, the reduction of friction, enhancement of accuracy, etc.

d. Reduction in costs of fuel economy improvement technology:

The improvement of production technology, the introduction of new construction methods, etc.

Although, the market trend is reflected by users' preference towards luxury and high-value-added cars, developments which will improve fuel economy technology are anticipated. The average fuel

economy is expected to maintain it's present situation even if substantial developmental improvements are not attained.

Measures for improvements in the traffic environment, such as a decrease in traffic congestion, is also important because fuel economy is influenced by movement patterns (an average speed, percentage of idling hours, etc.).

Also, methanol fuel is being studied as an alternative to petroleum fuel. The emission of CO<sub>2</sub> (per calorific value of fuel) from methanol at the consumption stage is 5% less than petroleum fuel. However, according to some sources, however, when all the stages are considered in the production of the fuel, circulation, distribution and consumption, the emissions of CO<sub>2</sub> from methanol gas made from natural gas is almost as much as in petroleum fuel. Methanol which has been made from coal has an emission which is a few times greater than petroleum fuel. Thus, it would be difficult to consider using methanol made from coal as an alternative fuel by which to reduce emissions of CO<sub>2</sub>.

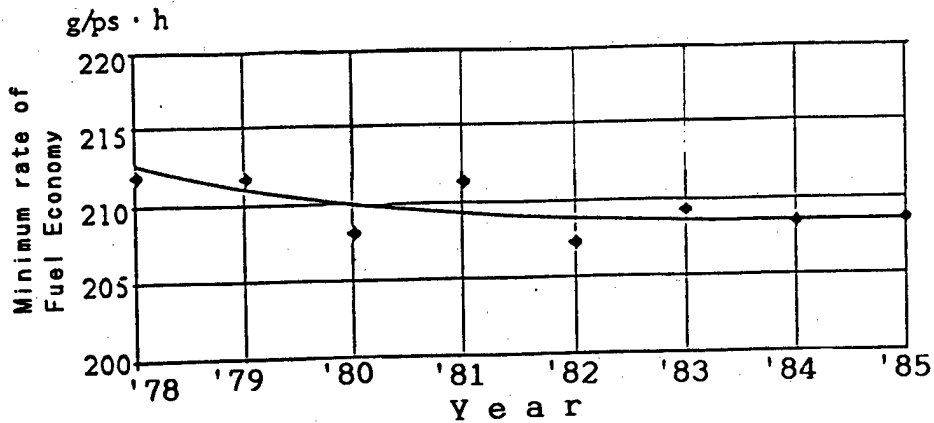

**Fig.6-1 Change in Minimum Rate of Fuel Economy**  
 Source: Japan Automobile Manufacturers Association (JAMA)

Note: The minimum rate of fuel economy (fully loaded) indicating that the performance of fuel economy within the engine alone shows no fluctuations and that which means that improvements in fuel economy by this means alone is reaching it's limit.

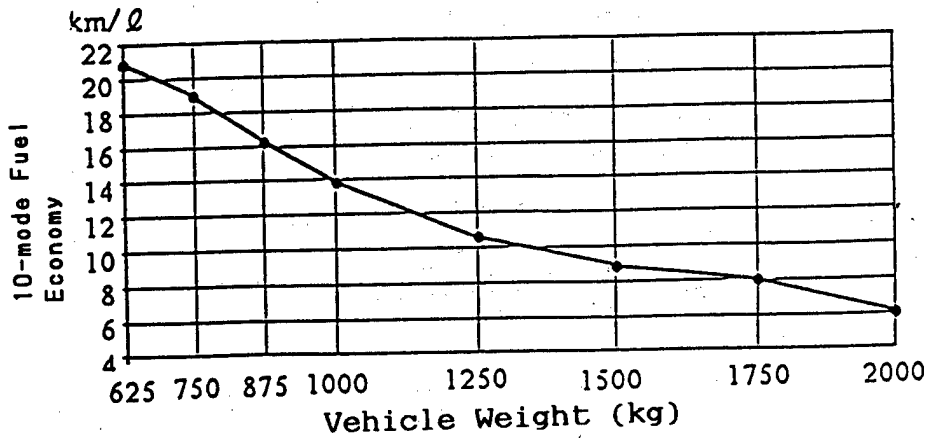

**Fig.6-2 Relationship between Vehicle weight and Fuel economy**  
 Source: JAMA

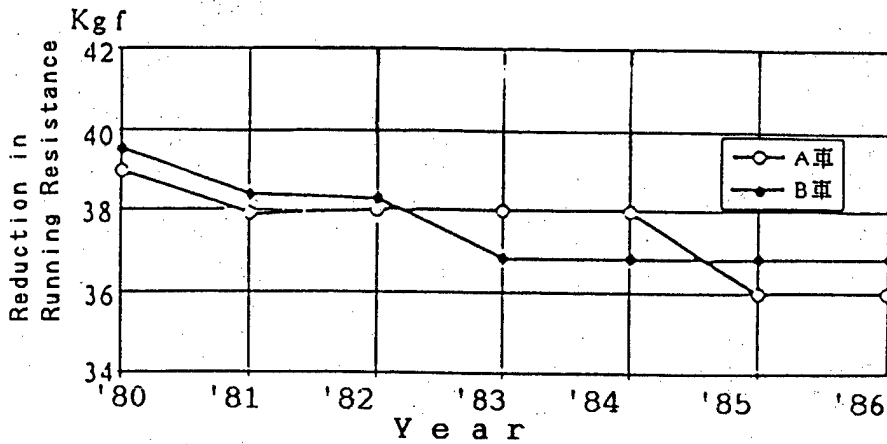

Fig.6-3 Example of Running Resistance Reduction  
Source: JAMA

Note: Entire running resistance has been reduced by a reduction in the rolling resistance followed by improvements in tires, body styling, etc.

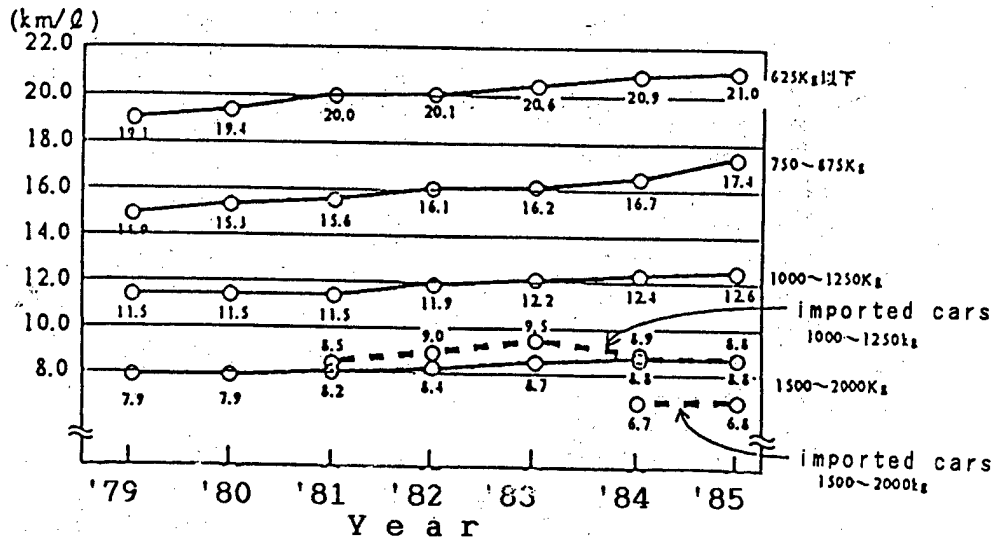

Fig.6-4 Change in 10-mode Fuel Economy of Passenger Cars  
(classified according to equivalent inertia weight)  
Source: JAMA

Note: Weighted average of automatic and manual transmission passenger cars produced for the domestic market

4-7 TECHNOLOGICAL MEASURES IN THE DESIGN AND USE OF BUILDINGS TO  
COUNTERACT THE EFFECTS OF GLOBAL WARMING (BY S. TANAKA,  
KAJIMA INSTITUTE OF CONSTRUCTION TECHNOLOGY)

1) The influence of the building

Buildings are highly dependent on the condition of the outdoor environment and it is possible that the effect of global warming may be exerted over a wide geographical area. However, in Japan's case:

- a. There is an accumulation of technological knowledge and experience which aids Japan in coping with its own wide range of climatic/environmental conditions.
- b. The new climatic conditions which have been predicted, suggest that they will be comparatively slight and that existing building designs will be able to meet such conditions.
- c. Countermeasures by which to control the emissions which result from the use of the building itself, measures for this are the responsibility of the individual building owner/occupant.

However, the subjects which need further investigation in the future include:

- a. More research on the effects on the indoor environment caused by a change in the climate such as changes in the warming trend and the cooling/heating load.
- b. Further details on local countermeasures which may be needed to accommodate changes which may occur due to a rise in sea level.
- c. An increased knowledge in areas in which conventional technology has a limited expertise. For example, the measures needed to be taken to arrest the deterioration of concrete which may be enhanced with an increase in the concentration of CO<sub>2</sub>.

2) Emission control of CO<sub>2</sub> related to the use of buildings and their future design. Measures which control the emissions of CO<sub>2</sub>

from the use of buildings, include energy conservation policies. Energy conservation practises related to buildings are as follows:

- a. The technology related to the architectural design include features such as making the surface area small, sunlit rooms/structures, insulating technology, consideration of the methods used to provide illumination and lighting, reductions in the size of windows.
- b. The technology related to air-conditioning engineering, for example optimization in the areas where such equipment is installed. Also, air-conditioning systems which are adapted to energy conservation, optimizing the rate at which fresh air is taken in and the full utilization of heat storage.
- c. The technology related to the design of electric engineering equipment, such as the optimized control of motors, decreased electrical losses through faulty wiring, adjustment of illumination, central control of elevators, etc.
- d. The technology related to the maintenance, operation and control of electrical appliances, such as a controlled lighting time schedule, automatic controls for the prevention of overcooling/overheating.

In order to achieve the aforementioned, energy conservation technology utilizes the accumulated knowledge from more than 100 minor technologies, as is shown in Figure 7-1. Each individual rate of energy saving is small, but as shown from the results of experimentally constructed houses which used a passive solar system, some designs reached a total 45% saving in the rate at which energy was used.

Energy conservation indicators, such as the Perimeter Annual Load (PAL), Coefficient of Energy Consumption for air-conditioning (CEC) are standardized when a new building is built, the levels set in these standards are illustrated in Fig. 7-1.

Energy conserving measures have been supported by loans from the Housing Loan Corporation or Japan Development Bank, and an increased awareness has been gained from the promotions of the Institute of Building Energy Conservation, and the academic activities of the Japan Architecture Society all of whom have supported the use of energy saving measures.

Technical subjects promoting energy conservation measures include:

- a. Investigation into the quality and standard of the indoor residential environment.
- b. Investigation of optimized technology adapted to the climate change.
- c. Improvements in energy conservation techniques such as in the operation and control technologies used in air-conditioning systems, efficient energy utilization for lights and conveyor belts, diagnostic technology for use in the assessment of energy utilization efficiency, information processing machines for energy saving.
- d. Improvements in architectural designs and features which would increase the efficiency of cogeneration and super heating pumps.
- e. Development of air-conditioning systems with heat storage facilities.
- f. Efficient utilization of district and urban energy (district cooling/heating)

3) The energy system of buildings with a low emission of CO<sub>2</sub>:

Building energy systems which produce low emissions of CO<sub>2</sub> are as follows:

- a. Active solar system

As a result of the technical developments achieved from the Sunshine Program in 1974, a practical level and usage was

reached so that now the number of solar water heaters (natural circulating type) is about 5 million and the number of the forced circulating solar system is about 0.3 million. Almost all of them are used for the supply of hot water. These are the current figures but recently their numbers have been declining.

b. Passive solar system

They utilize energy from natural sources and phenomenon (solar radiation, air and wind, heat capacity of ground, nocturnal radiation) without depending upon machinery. There are a lot of practical examples of these in use within individual houses and recently these systems are being favourably reconsidered.

c. Local energy sources such as the use of photo-cells, wind power generation are a few examples to date of their use within buildings. Roof tiles which are solar batterys are at the stage of research and development. The subjects of these energy system are the improvement in reliability, lower cost, integrated adaptation of multiple technologies.

Furthermore, we expect more research and development on fuel batterys. They can achieve a higher generation of electricity by changing the chemical energy of the fuel into electrical energy directly and continiously without converting it back into heat energy. It is also expected that more research and development will be carried out on the co-generation system which produces the heat at the same time as it produces the electric power or motive power from the fuel.



4-8 THE APPLICATION OF APPLIED TECHNOLOGIES FOR THE FIXATION OF  
CARBON DIOXIDE (BY H. KOMIYAMA, UNIVERSITY OF TOKYO)

It is necessary to study the circulation of Carbon, when considering how applied technologies may be used in the fixation of carbon dioxide. Photosynthesis, the food chain and erosion are the main stages involved in the cycle. However, there is still much to be learnt about the circulation of Carbon such as the "missing sink", it can be shown generally as follows:

Source of Carbon: Fossil Fuel 50 (UNIT: 100 million tons/Year)

Plants	16 (2±8)
--------	----------

Sink of Carbon :

Air	25
Sea	41 (±8)

There is still much we need to learn about the very complicated circulation of Carbon in the ocean. When simplified, it may be illustrated in Fig. 8-1. It shows that photosynthesis occurs at the surface layer and that Carbon is carried down as a solid. Although, the deeper sea holds more CO<sub>2</sub> in solution it is carried up by diffusion. The difference between these two movements is in the degree of interchange between the atmosphere and the ocean, lately more has been going from the air into the seas in total.

Applied technologies for CO<sub>2</sub> fixation which have recently been suggested are classified and evaluated in Table 8-1. This classification has been based on consideration of the balance of substances and energy in the system as a whole. Among these, the utilization in beverages and dry ice can not be considered as fixation, because they diffuse away directly. Also carbonation such as CaO cannot be considered as fixation, because the same amount of CO<sub>2</sub> is created in the process of making the CaO.

In order to achieve fixation, some new energy sources which do not create CO<sub>2</sub> are required. For example, utilizing CO<sub>2</sub> by changing it into methanol and methane is fixation, but it needs hydrogen in the process and it will have little effect on the amount fixed unless a new energy source is found. The same applies for energy plantation, such as making alcohol from corn. If we consider the energy needed for fertilization, seeding, harvesting, distilling and refining, it often requires more energy than it can create.

There are four important criteria relevant to the applied technologies for the fixation of CO<sub>2</sub> : 1) the period when it is to be fixed, 2) the amount to be fixed, 3) the speed of the fixation and 4) the cost.

Table E-1 is classified on the basis of the fixation period. The amounts which can be fixed on a short time scale are deemed to be small. The technologies applicable to the shorter periods of fixation are classified under the following categories:

1) Utilization as a Polymer:

Utilization as a polymer has advanced technologically and the speed of the fixation is fast. However, it requires the process of copolymerization which needs a lot of energy and its current cost is high. It would be expected to fix approximately 0.1% of the CO<sub>2</sub> produced in Japan.

2) Production of substances by artificial Photosynthesis:

Up to now, this research has been carried out with the aim of producing useful substances such as sugar. The amount fixed by this method is expected to be small.

3) CO<sub>2</sub> enriched cultivation techniques in Greenhouses:

This technique speeds up the growth of plants. However, if the

plants grown are annuals, they will release the CO<sub>2</sub> which they had fixed within 1-2 years and is thus not expected to be a long-term fixation.

4) Fixation by Plankton in the sea: 07 3

If the Carbon is fixed as a carbohydrate, it will release CO<sub>2</sub> when it is eroded and thus there is no ultimate long term fixation.

However, the methods by which a longer fixation period can be achieved are as follows:

1) Disposal into an abandoned mine or oil well:

This would involve the transformation of collected CO<sub>2</sub> into dry ice and its disposal into an abandoned mine or an oil well. If this is carried out on a large scale, there is a possibility of some CO<sub>2</sub> being released. Finding suitable locations poses problems and it is not a realistic proposition within Japan.

2) Plant Life:

Trees and leaves are examples of a real living and existing form of fixation. If we had to fix the CO<sub>2</sub> emitted from all over the world by such a method, we would have to keep creating approximately  $4 \times 10^5$  Km<sup>2</sup> of forest every year. If we could forest the Sahara desert, the amount of Carbon which would be fixed would be the same quantity as the amount of CO<sub>2</sub> emitted over the next 25 years.

3) Coral:

This involves fixing the CO<sub>2</sub> which has been emitted as CaCO<sub>3</sub> by using the Calcium ions which exist in the ocean in large quantities. However, today it is understood that the considerable amount of carbonate which has been fixed in the sea,

such as coral can dissolve again into the sea. The amount fixed as carbonate in the sea each year is estimated to be almost equal to the quantity of carbonate emanating from river sources.

Absorbtion of CO<sub>2</sub> by the sea is presently considered as long-term fixation, and in this case the supply of fertilizing components (N, P) and mixing in the sea will be important factors.

The density distribution of Carbon generally corresponds to that of the fertilizing components. The supply of fertilizing components could also be effective in promoting photosynthesis. Also, the absorbtion of CO<sub>2</sub> in the sea ultimately depends on the rate at which it is absorbed, mixing plays an important factor here. The thermodynamic miminum energy needed for mixing is theoretically zero, the sea itself is not in equilibrium; so it is considered theoretically feasible to get the necessary energy for mixing from the sea itself.

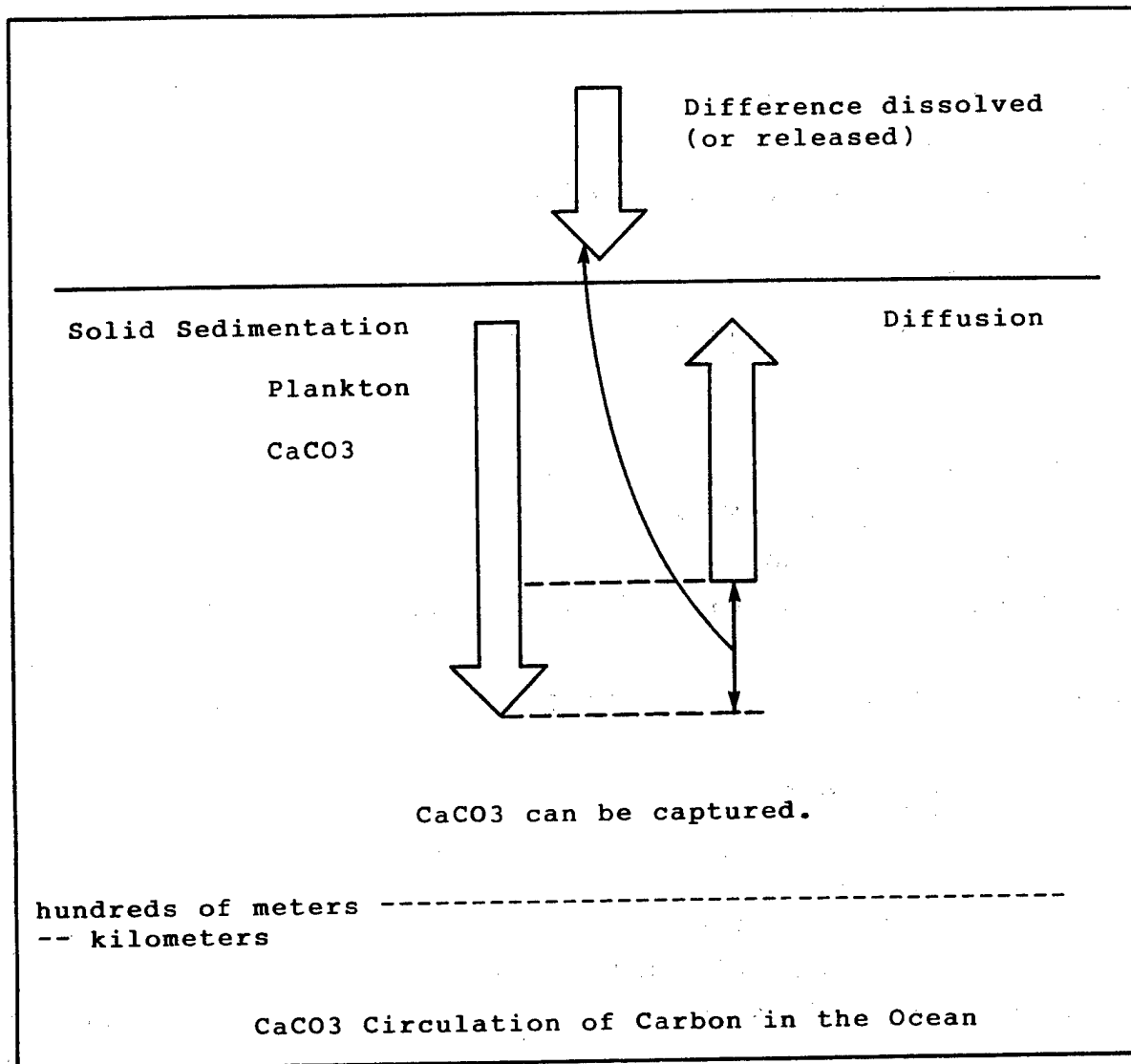

Figure 8-1 Circulation of Carbon in the Ocean

Table 8-1 Classification and Evaluation of applied technologies  
for the fixation of CO<sub>2</sub>

EVALUATION

Physical Processes

- 1) Utilization (beverages, fire extinguishers, aerosol dry ice)  
Not Fixed
- 2) Absorbtion (by the ocean) Long
- 3) Disposal (e.g. abandoned mine, oil well, deep sea) Long

Chemical Processes

- 1) Carbonation (e.g. CaO + CO<sub>2</sub> - CaCO<sub>3</sub>) Not Fixed
- 2) Bubbles (e.g. "Babu")
- 3) Polymer (e.g. Copolymerization with CP<sub>2</sub>H<sub>2</sub>O) Short
- 4) Artificial Photosynthesis (e.g. Porphyrin as catalyzer) Short
- 5) Methanol, Methane New Energy

Biological Processes

- 1) On the Ground Plant Life Long
  - CO<sub>2</sub> Enrichment in Greenhouses Short
- 2) In the Ocean Plankton Short(?)
  - Coral Long
  - Plants Short
- 3) Energy Plantation New Energy

- 
- 1. Not fixed
  - 2. New Energy (e.g. Solar, Nuclear) required
  - 3. Fixation period: Long fixation period over 10 years.  
Short fixation period less than 10 years.

4-9 THE EFFECT OF EMISSION CONTROL ON GREENHOUSE AND WARMING RELATED GASES AND THE CURRENT COUNTERMEASURES USED IN ENVIRONMENTAL POLLUTION CONTROL (BY H. AKIMOTO, NATIONAL INSTITUTE FOR ENVIRONMENTAL STUDIES)

1) The intensity of the current emissions of greenhouse and warming related gases in our country have been realized. The estimate of the effect of emission controls on these gases by current countermeasures used in environmental pollution control have been made.

a. The current level of emissions for (A) CO<sub>2</sub> is as follows:

Table 9-1 shows the amount of CO<sub>2</sub> emitted in 1985 from each sector within Japan, as calculated from the energy consumption in the Energy Balance Table and CO<sub>2</sub> emissions factors per unit consumption for each fuel type taken from Marland et al.

Fig. 9-1 shows the change in emissions of CO<sub>2</sub> for every 5 years from 1965 to 1985. In Japan, the emission of CO<sub>2</sub> from the manufacturing industry is the highest, this is followed by the electricity generating sector. The emissions of CO<sub>2</sub> per unit consumption of energy has been decreasing since 1970.

This trend is due to the use of lighter fuels and the effect on emissions from the electric power generating sector has been remarkable. The decrease in the amount of CO<sub>2</sub> emitted since 1975 by the manufacturing industry is illustrated in Fig. 9-1. This trend is thought to be due to the effect of energy saving measures.

In terms of the amount of CO<sub>2</sub> emitted from automobiles (per running kilometer) the decrease in the 1960's was extraordinary and remained nearly constant since the 1970's. This is

might be attributable to improvements in fuel efficiency being offset by the use of heavier vehicles and automobiles with larger engines.

b. Other gases

The amount of NO<sub>x</sub> emitted from fixed sources is approximately the same as that from mobile sources. The yearly trend of NO<sub>x</sub> emitted from both sources is nearly parallel. The amount of CO emitted from fixed sources is about one tenth of that from automobiles, and has been steadily decreasing since 1965 as shown in Fig. 9-3.

Fig. 9.5 to 9.7 show the amount of CO, HC, and NO<sub>x</sub> emitted from automobiles per unit running kilometer. These were calculated using the emission factors obtained from Tokyo-to, Osaka-fu, and Kawasaki-shi. These figures show that the emission per unit running kilometer of air pollutants has decreased remarkably since 1970. The anthropogenic source strengths of methane and N<sub>2</sub>O for Japan have been estimated and are given in Tables 9-2 and 9-3.

2) The effect of emission controls under the current countermeasures used for curtailing environmental pollution. Current countermeasures for decreasing environmental pollution have been developed by controlling the emissions of SO<sub>2</sub>, SPM, NO<sub>x</sub> and harmful substances from fixed sources and CO, NHHC, NO<sub>x</sub>, and black soot from mobile sources.

The use of lighter fuels, improvements in combustion efficiency and treatment of the exhaust gases have also been pursued. The amount of warming related gases such as CO, NO<sub>x</sub> and HC being emitted is steadily decreasing as a result of the existing countermeasures, since these are pollutants which are currently sub-



jected to environmental pollution control.

The amount of CO<sub>2</sub> emitted is decreasing as a result of using lighter fuels and improvements in combustion efficiency. Current countermeasures used for environmental pollution control and the adoption of energy saving measures have largely contributed to the decrease in CO<sub>2</sub> emissions.

Thus, current countermeasures used in environmental pollution control should be evaluated in order to assess the role of their control in the emission of greenhouse gases.

Futher research efforts are needed if the aim of limiting future global warming is to be achieved.

#### Bibliography:

- 1) Japan Energy Economy Institute: "The table of energy balance, 1965, 1970, 1975, 1980, 1985"
- 2) G. Marland and R. Rolly: Carbon Dioxide Emission from Fossil Fuels: A Procedure for Estimation and Result for 1950-1981. DOE/NBB-0083, 1983: Emission factors of 23.8, 19.2 and 13.7 (MtC/1018 J) from the coal, petroleum and natural gas have been used.
- 3) The manufacturing sector of industry including coal consumption used for manufacturing coke.
- 4) Ministry of Transport "Annual Report of Automobile Transport Statistics", 1988.

Table 9-1 The amount of CO<sub>2</sub> emitted in Japan as estimated from energy consumption (1985)

Generation of electricity	66.2(28%)
Primary industry	8.1( 3%)
Manufacturing industry	86.1(36%)
Residential and commercial	48.6(21%)
Transportation	
<b>Total</b>	<b>235.9</b>

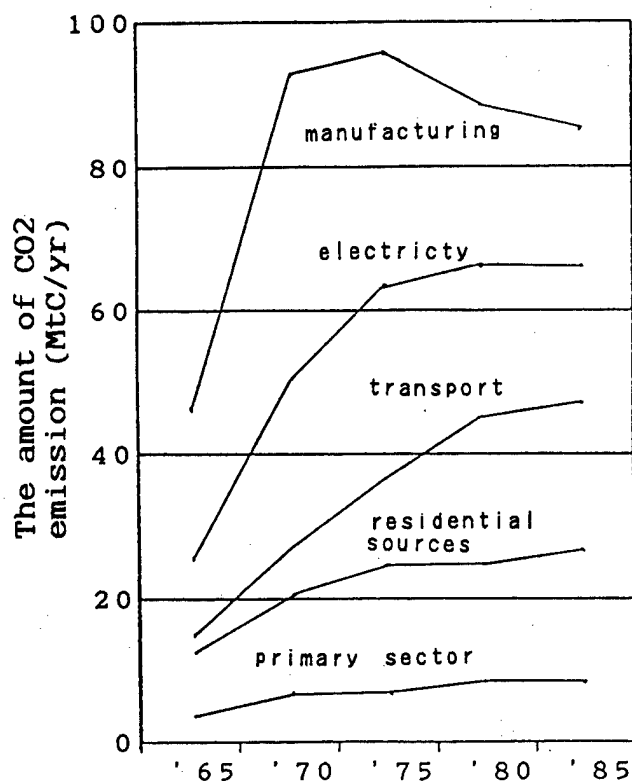

Fig.9-1 The change in the emissions of CO<sub>2</sub> from the electricity generation sector, primary industry, manufacturing industry, manufacturing industry, commercial and residential sources, and transportation sources in Japan.

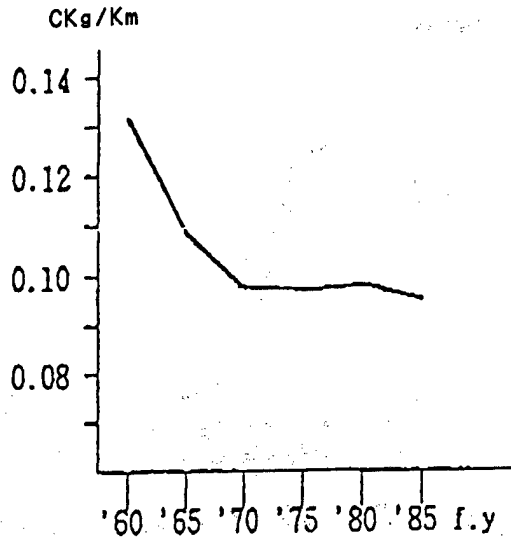

Fig.9-2 The CO<sub>2</sub> emissions from automobiles per unit running kilometer (including trucks)

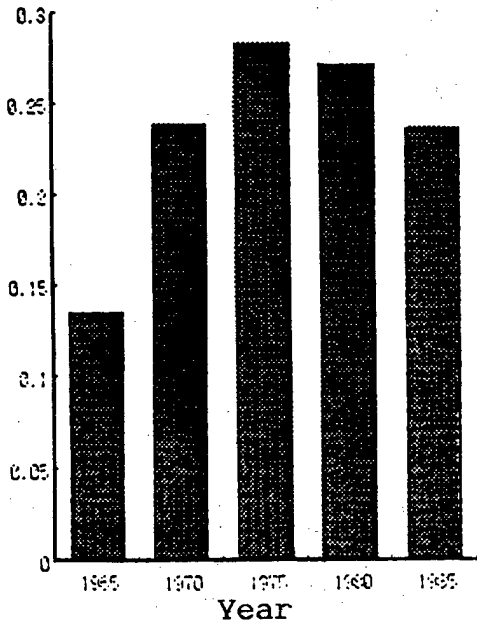

Fig.9-3 The amount of NO<sub>x</sub> emissions from fixed sources (N-converted)

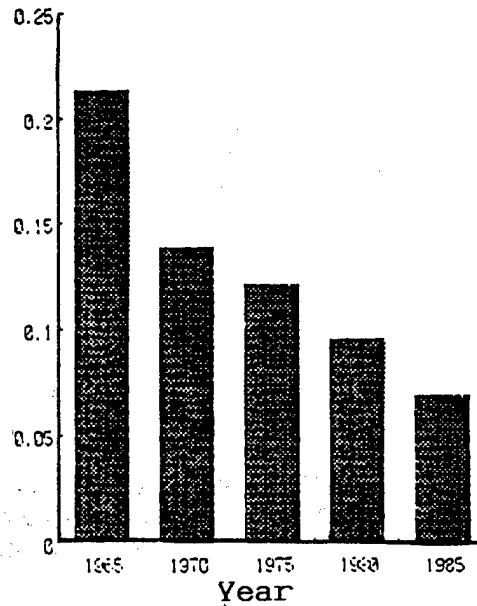

Fig.9-4 The emissions from fixed sources (C-converted)

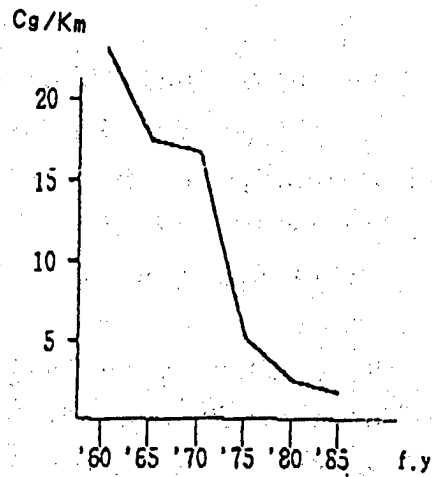

Fig.9-5 The CO emissions from automobiles per unit running kilometer (including trucks)

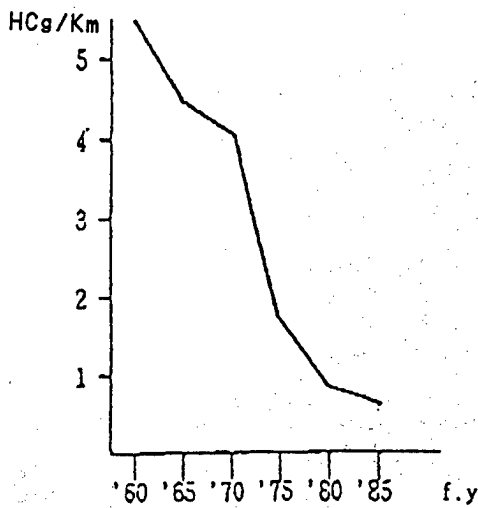

Fig.9-6 The HC emissions from automobiles per unit running kilometer (including trucks)

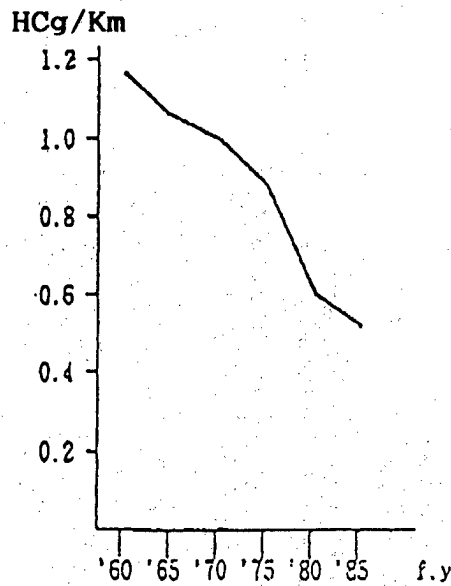

Fig.9-7 The NOx emissions from automobiles per unit running kilometer (including trucks)

Table 9-2 The anthropogenic sources of methane from Japan.  
(Mt-CH<sub>4</sub>/yr)

	Japan
rice paddies	0.1-0.8
city waste	0.21
sewage disposal	0.16
natural gas	0.02
automobile exhaust	0.01-0.1
total	0.5-1.3

Table 9-3 The anthropogenic sources of N<sub>2</sub>O from Japan. (Mt-N/yr)

	Japan
fuel burning	0.076-0.22
fixed sources	0.016-0.16
mobile sources	0.06
total	0.076-0.22

4-10 THE PROBLEM OF GLOBAL WARMING: DEVELOPING COUNTRIES'  
PERSPECTIVES (BY H. SAZANAMI, UNITED NATIONS CENTER FOR  
REGIONAL DEVELOPMENT)

1) Major Causes and Possible Countermeasures

A review of the global trend of CO<sub>2</sub> emissions from fossil fuel consumption by region shows that the total volume of CO<sub>2</sub> emissions originating from the developing countries as well as its contribution to the world total are on a sharp increase. This trend is illustrated in Fig. 10-1.

Furthermore, deforestation is taking place at a rapid pace and on an increasingly extensive scale in the developing countries. This adds CO<sub>2</sub> to the atmosphere by reducing the CO<sub>2</sub> absorptive capacity on one hand and by releasing CO<sub>2</sub> fixed in the plants on the other. While deforestation due to excessive firewood production is conspicuous in Asia and Africa, indiscriminate expansion of ranches is the main cause of forest destruction in Latin America. The total volume of CO<sub>2</sub> emissions associated with deforestation in developing countries accounts for about 95% of the world total, as is shown in Fig. 10-2 to 10-4.

Considering the very challenge which developing countries are invariably facing today there is a need for them to cooperate with the developed countries in order to address the problem of global warming. Although the promotion of economic development programmes geared to the eradication of poverty and its associated problems is indispensable, it is also necessary for the developed countries to extend viable assistance programmes to the developing countries. Some of the possible areas of action by the developed countries include:

- a. Assistance to the developing countries in promoting research and development in the fields of energy saving technology and

alternative energy sources (solar, biomass, tidal, wind, etc.) commensurate with the area-specific social, cultural, economic, and physical environmental conditions;

- b. Appeal and encourage the developing countries to join the Montreal Protocol while putting forward a set of well-formulated assistance programmes designed to assist the developing countries in curtailing the use and production of CFCs. Also, it would be essential to extend technical assistance in the monitoring and implementation of measures against other trace greenhouse gases;
- c. Explore viable methods by which to facilitate a smooth transfer from the developed countries to the developing countries of innovative anti-warming technologies (e.g. technical assistance, provision of free access to specific patents, etc.);
- d. In institutionalizing a charge system for fossil fuel use on an international scale, it is essential to make clear the scope of the system, the share of financial burden among the countries concerned, and the uses of the fund raised from the charge system, in order to ensure a proper understanding on the part of the developing countries;
- e. Promotion of not only financial assistance in afforestation programmes, but also technical assistance in developing region specific afforestation technology as well as in fostering a social environment which is more conducive to a wider local community participation/involvement in afforestation. In addition, policy efforts need to be directed to curtail commercial logging as well as the establishment in the developed countries of a charge system specifically designed

for the use of tropical timber so as to create a source of fund by which to promote afforestation programmes in the developing countries;

f. Assist developing countries in formulating and implementing proper agricultural development programmes; as well as in promoting the development of technologies required to improve crop yields, in an attempt to curtail the rate of deforestation through the indiscriminate expansion of commercial plantations, the practise of slash-and-burn farming, and overgrazing. At the same time, a thorough review must be made of private investment programmes within the agricultural sector; and

g. Institutionalize an integrated financial assistance programme whereby the necessary costs for environmental protection are automatically accounted for, so as to ensure a smooth integration of the necessary environmental measures into any major development assistance schemes.

## 2) Policy Responses to the Effects of Global Warming in the Developing Countries:

It is forecasted that global warming is likely to bring about many and varied effects on the world community, including effects on agriculture and food production, energy use and development, national land resources management, urban infrastructure, health, etc. The extent and severity of the effects are not predictable in a precise manner at present. However, it is not so difficult to speculate that the consequences of global warming on the societies of the developing world will be much greater and severer than those on the developed countries, considering the common restraints of developing countries such as a fragile ecology, low levels of agricultural productivity, limited



availability of essential facilities and infrastructure, financial constraints, etc.

Today, many developing countries are plagued with critical problems of environmental and natural resource base deterioration, besides the repeated occurrence of severe natural disasters. Hence, when considering responses and actions to be taken by the developing countries against global warming, policy priority must be directed, first and foremost, to the development of a sound national land base with a flexible yet resilient social system. This may be achieved by addressing the immediate problems of poverty and other associated issues through a regional approach geared to promoting a balanced national development.

At the same time, keen attention must be directed to a number of more practical issues. For example, the building up of a comprehensive data base and refine simulation models would be indispensable so that more reasonable and precise predictions on the effects of global warming are obtainable. The effects which need to be forecasted in a more precise and accurate manner include changes in precipitation patterns, which significantly affect the levels of agricultural production and the availability of water resources.

The International Decade for Natural Disaster Reduction (IDNDR) commences in 1990, it will be crucial to ensure an effective coordination and integration between the programme activities of IDNDR and the policy actions and responses to global warming. Areas in which close coordination is required include:

The development of an information system on climatic changes, forecasting of the effects of global warming, research and development in the field of countermeasures to the adverse effects of global warming, and manpower development and training.

It will be also crucial to facilitate the integration of the developing countries into the assistance programmes a set of well-defined, responsive policy measures against the effects of global warming.

### 3) Concluding Remarks

As mentioned above, in order to cope up with environmental problems of a global scale, it will be indispensable to foster a closer collaboration and cooperation between the developed and developing countries in a wide variety of fields, ranging from the collection of basic data to research and development on preventive measures and technologies. In this connection, an immediate task before us is to assess the feasibility of, and materialize some concrete action proposals already put forward, such as the establishment of an international fund as well as an international organization for vigorously promoting research and development, formulation and implementation of environmentally sound development programmes, and other action projects specifically designed to combat global warming.

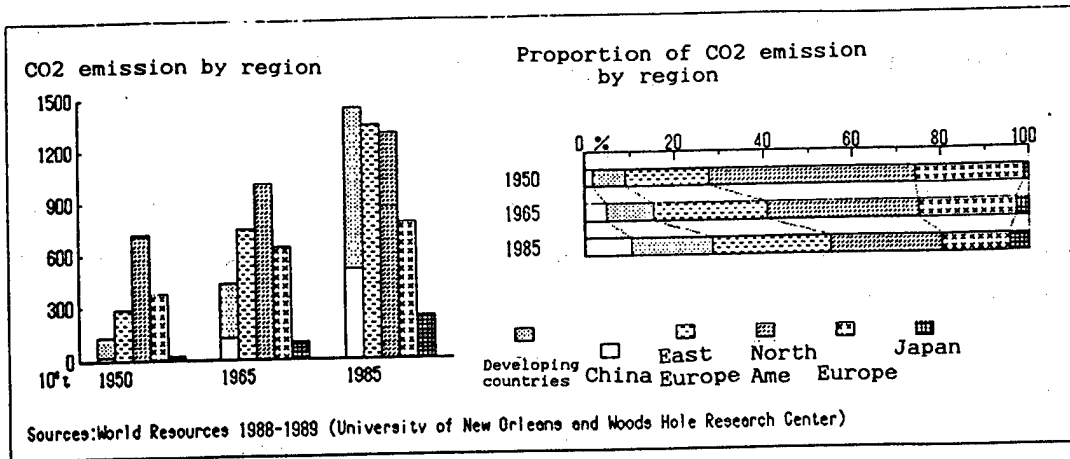

Fig. 10-1 Changes in the emissions of CO<sub>2</sub> from fossil fuel consumption, 1950-1985

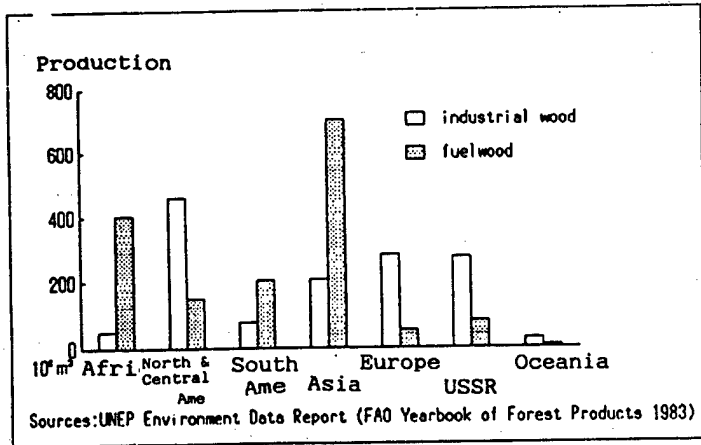

Fig. 10-2 Industrial wood and fuel wood production, 1981-1983 (mean annual values)

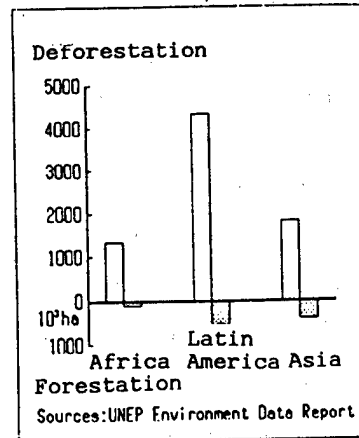

Fig. 10-3 Forest resources in tropical countries, 1981-1985

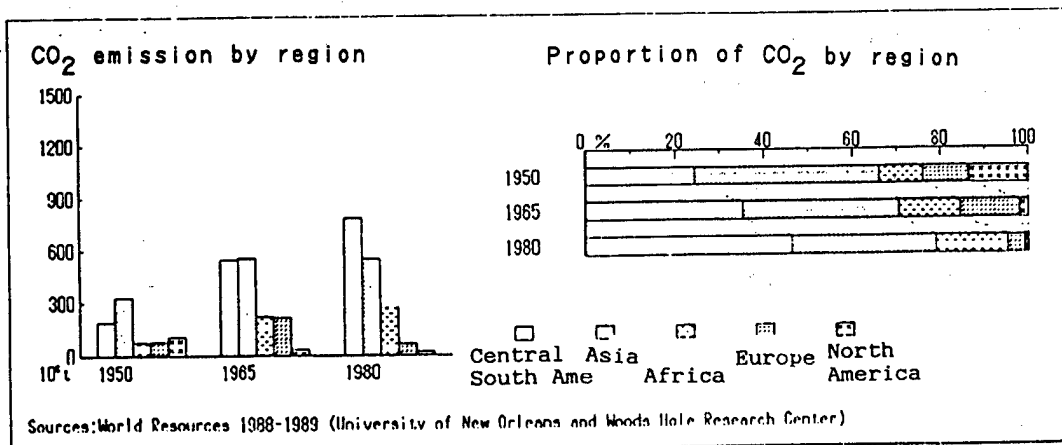

Fig. 10-4 Changes of CO<sub>2</sub> emission from deforestation, 1950-1980

4-11 POLICY OPTIONS FROM A REPORT BY US EPA (BY S. NISHIOKA,  
NATIONAL INSTITUTE FOR ENVIRONMENTAL STUDIES)

This paper briefly considers what kind of countermeasure are effective in dealing with global warming. The effectiveness of countermeasure procedures are comprehensively shown in Fig. 12-1, taken from the report of the EPA's Policy Options for Stabilizing Global Climate (Draft report to Congress) which was announced in February 1989.

Basically, two cases are taken where the social condition will either rapidly or slowly change in future, also a further two more cases are considered where countermeasure to control warming are either adopted or not. Temperature rise by 2010 is projected by these four scenarios.

In this EPA model, the buffer action of ocean is taken into consideration, which makes this model more realistic than conventional models. The rise in temperature in the EPA model is less than in existing models which have calculated the degree of warming before equilibrium is attained (the temperature rise reached in the future, in the case where the concentration of greenhouse gases in the air remains unchanged.). There are many uncertainties in the relation between the concentration of greenhouse gases and the rise of temperature. However, in this model the rise of temperature when CO<sub>2</sub> concentration is double is estimated between 2-4° as a result in the equilibrium warming case.

In the rapidly and slowly changing world the estimated temperature rise is 4-6° and 3-4° respectively, but in the case of "with policy" a rise in temperature of less than 2° is estimated, as shown in Fig. 12-2.

The effectiveness of policy options in decreasing the extent of

warming in the rapidly changing case is calculated in the equilibrium warming case and the result is shown in Fig. 12-3. According to this, commercialized biomass, a high increase in energy efficiency, and reforestation are effective, and if all such countermeasures are inacted simultaneously, a 45% decrease in temperature rise will be expected by 2050, and a 65% decrease in temperature rise will be expected by 2100. This case corresponds to the RCWP case represented in Fig. 12-2.

The accelerated effect when more effective countermeasures are taken is shown in Fig. 12-4. It is expected that about a 20% decrease can be attained if all the countermeasures are taken.

It is essential that such policy options are taken by all countries at the same time. If the developing countries do not join, the effectiveness of the policy is estimated to be half. If countermeasures are taken later, the effectiveness of the policy options will be insufficient. Thus, it is essential to start countermeasures early and in a way which is internationally cooperative.

Fig. 11-1

### STRUCTURE OF THE ATMOSPHERIC STABILIZATION FRAMEWORK

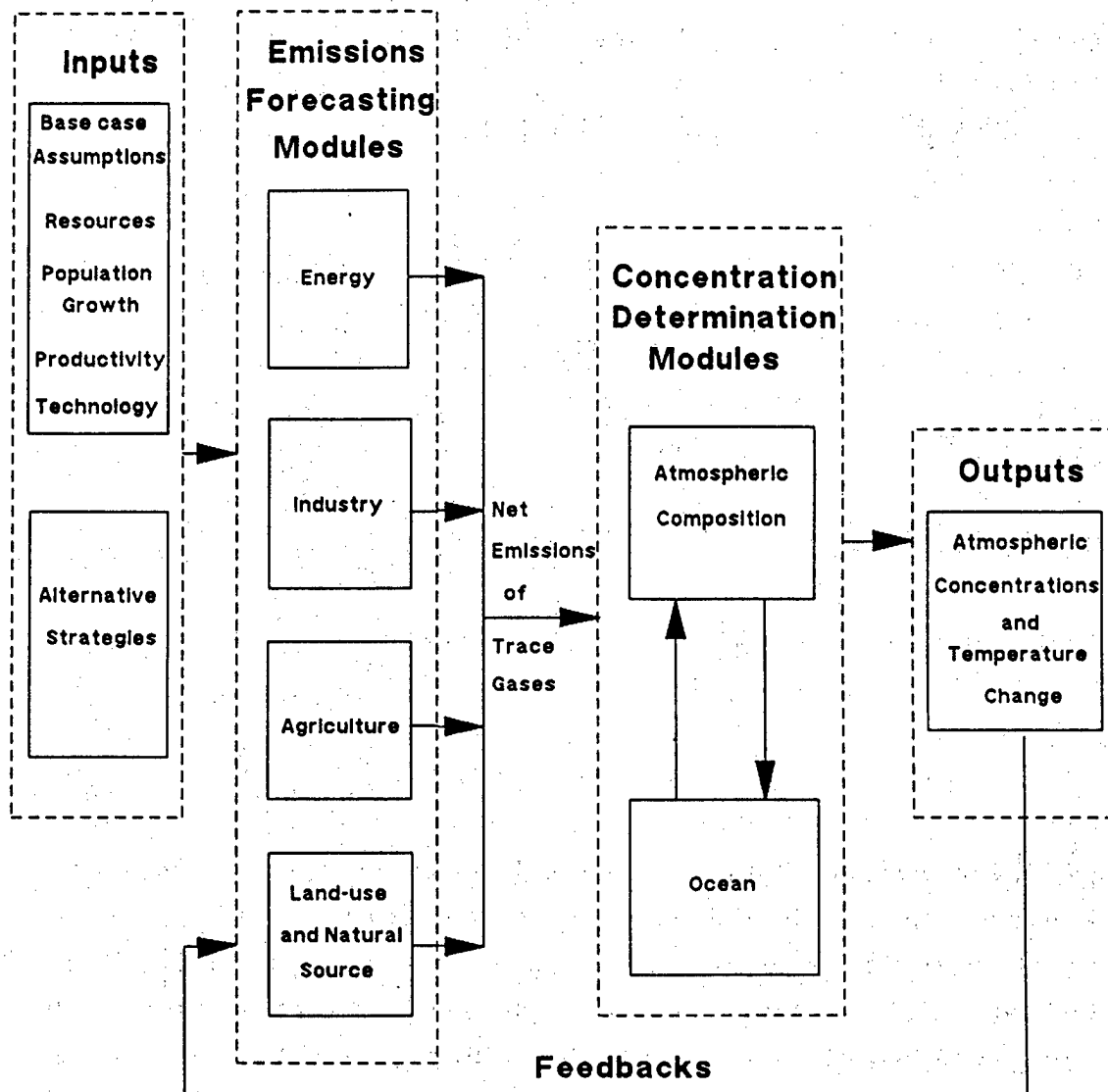

# REALIZED WARMING: NO RESPONSE AND STABILIZING POLICY SCENARIOS

(Degrees Celsius; 2.0 - 4.0 Degree Climate Sensitivity)

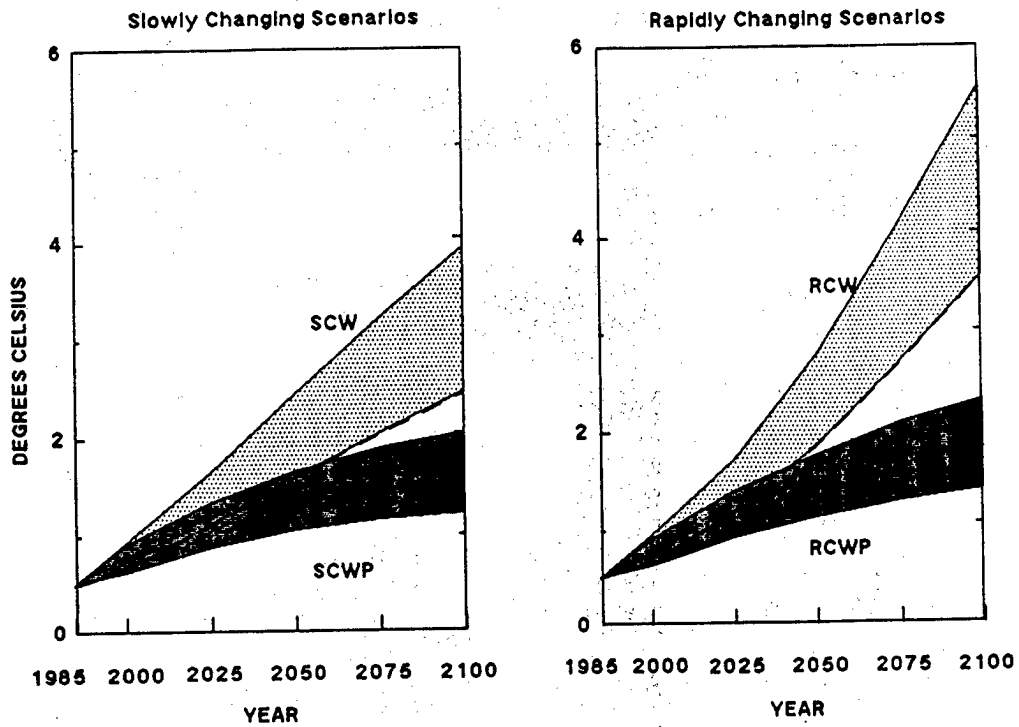

Fig. 11-2 Shaded areas represent the range based on an equilibrium climate sensitivity to doubling CO<sub>2</sub> of 2-4°C.

## STABILIZING POLICY STRATEGIES: DECREASE IN EQUILIBRIUM WARMING COMMITMENT

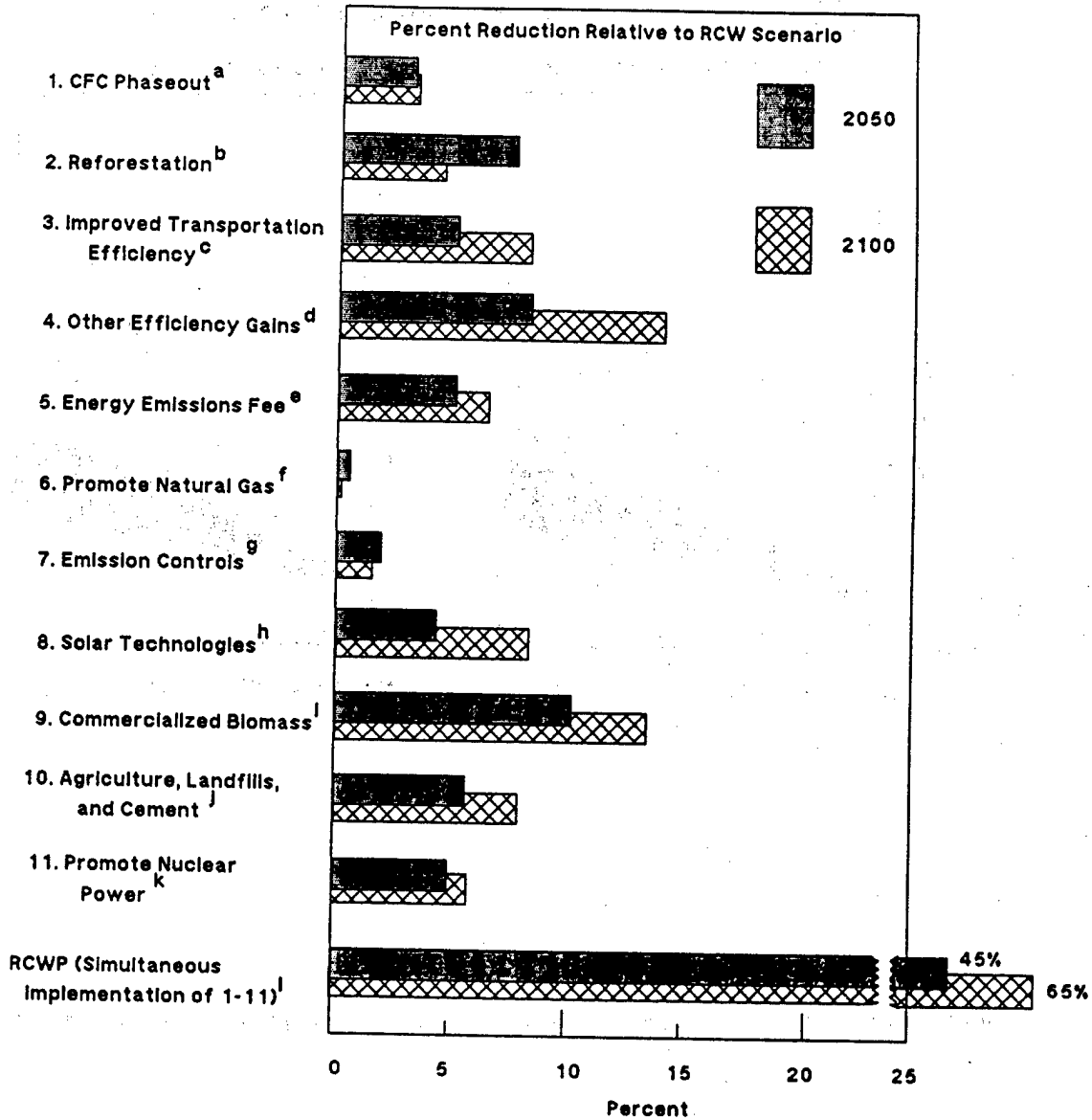

Fig. 11-3 The impact of individual measures on the equilibrium warming commitment in the RCW scenario. The simultaneous implementation of all the measures represents the RCWP scenario.



# Policy Options for Stabilizing Global Climate -- Review Draft

## Executive Summary

### Impact Of Stabilizing Policies On Global Warming

- a. A 100% phaseout of CFCs by 2003 and a freeze on methyl chloroform is imposed. There is a 100% participation by industrialized countries and a 94% participation in developing countries.
- b. The terrestrial biosphere becomes a net sink for carbon by 2000 through a rapid reduction in deforestation and a linear increase in the area of reforested land and biomass plantations. Net CO<sub>2</sub> uptake by 2025 is 0.7 Pg C per year.
- c. The average efficiency of new cars in the U.S. reaches 40 mpg (5.9 liters/100 km) by 2000. The global fleet-average efficiency of automobiles reaches 50 mpg by 2025 (4.7 liters/100 km).
- d. The rate of energy efficiency improvements in the residential, commercial, and industrial sectors is increased about 0.1-0.2 percentage points by 2025 compared to the RCW, and about 0.3-0.4 percentage points annually from 2025-2100.
- e. Emission fees are placed on fossil fuels in proportion to their carbon content. Maximum production fees (1985 \$ ) were \$ 0.50/GJ for coal, \$ 0.36/GJ for oil, and \$ 0.23/GJ for natural gas. Maximum consumption fees were 28% for coal, 20% for oil and 13% for natural gas. These fees increase linearly from zero, with maximum consumption fees charged by 2025 and maximum production fees charged by 2050.

- f. Assumes that economic incentives accelerate exploration and production of natural gas, reducing the cost of locating and producing natural gas by an annual rate of 5% relative to the RCW scenario. Incentives in the use of gas for electricity generation increases the gas share by 5% in 2025 and 10% thereafter.
- g. Assumes more stringent NO<sub>x</sub> and CO controls on mobile and stationary sources including all gas vehicles using three-way catalysts in OECD countries by 2000 and in the rest of the world by 2025 (new light duty vehicles in the rest of the world uses oxidation catalysts from 2000 to 2025); from 2000 to 2025 conventional coal boilers used for electricity generation are retrofit with low NO<sub>x</sub> burners, with 85% retrofit in the developed countries and 40% in developing countries; starting in 2000 all new combustors used for electricity generation and all new industrial boilers require selective catalytic reduction in the developed countries and low NO<sub>x</sub> burners in the developing countries, and after 2025 all new combustors of these types require selective catalytic reduction; other new industrial non-boiler combustors such as Kilns and Dryers require low NO<sub>x</sub> burners after 2000.
- h. Assumes that low-cost solar technology is available by 2025 for as little as 4.6 cents/kwh.
- i. Assumes the cost of producing and converting biomass to modern fuels reaches \$4.00/gigajoule (1985 \$) for gas and \$6.00/gigajoule (1985 \$) for liquids. The maximum amount of liquid or gaseous fuel available from biomass is 210 exajoules.
- j. Assumes that research and improved agricultural practices result in an annual decline of 0.5% in the emissions from rice production, enteric fermentation, and fertilizer use. CH<sub>4</sub>

emissions from land-fills are assumed to decline at an annual rate of 2% in developed countries due to policies aimed at reducing waste and land-fill gas recovery; emission in developing countries continue to grow until 2025 then remain flat due to incorporation of the source policies. Technological improvements reduce demand for cement by 25%.

k. Assumes that the cost of nuclear technology declines by 0.5% per year.

l. Impact on warming when all the above measures are implemented simultaneously. The sum of each individual reduction in warming is not precisely equal to the difference between the RCW and RCWP cases because not all the strategies are strictly additive.

## RAPID REDUCTION STRATEGIES: ADDITIONAL DECREASE IN EQUILIBRIUM WARMING COMMITMENT

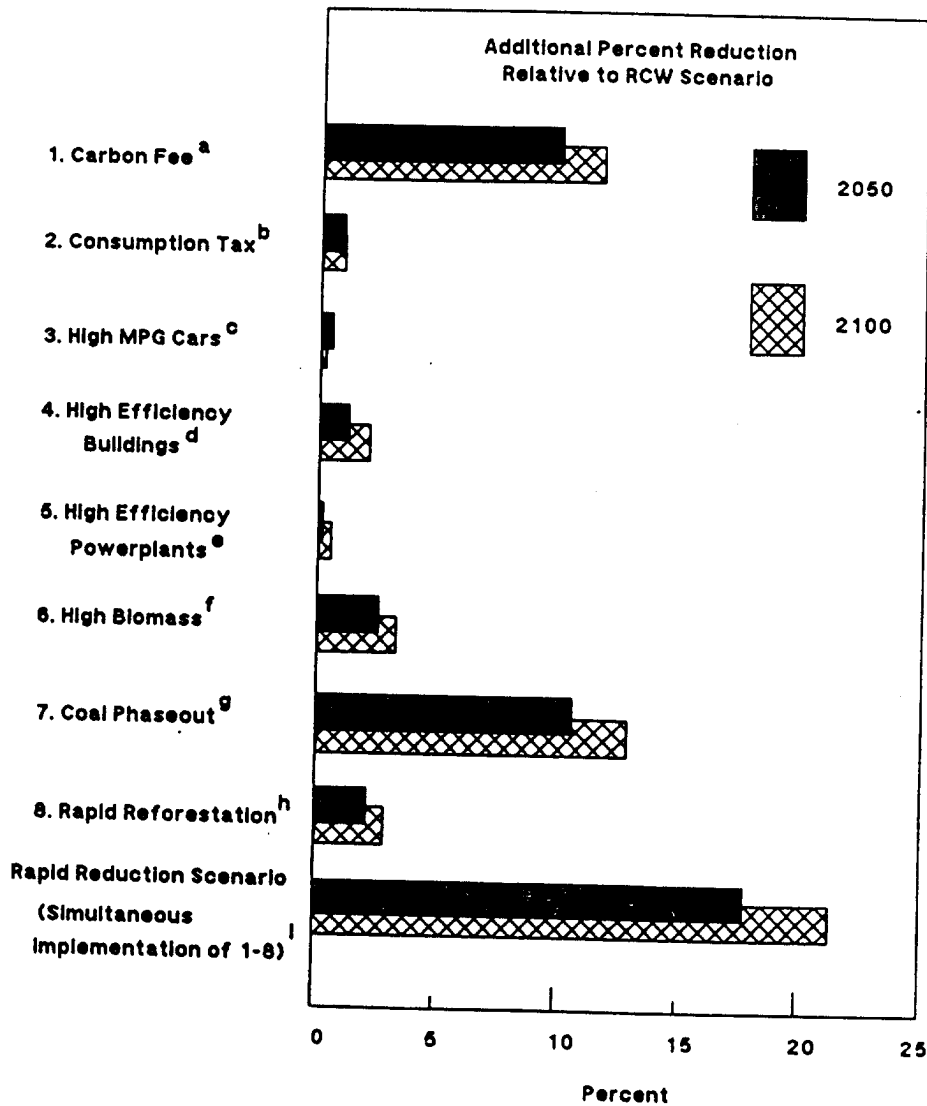

Fig. 11-4 The impact of additional measures applied to the RCWP scenario expressed as percent change relative to the equilibrium warming commitment in the RCW scenario. The simultaneous implementation of all the measures in combination with the measures in the RCWP scenarios represents the Rapid Reduction scenario.

## Policy Options for Stabilizing Global Climate -- Review Draft

### Executive Summary

#### Impact Of Rapid Reduction Policies On Global Warming

- a. High carbon emissions fees are imposed on the production of fossil fuels in proportion to the CO<sub>2</sub> emissions potential. In this case, fees of \$ 8.50/GJ were imposed on unconventional oil production, \$5.70/GJ on coal, \$2.30/GJ on oil, and \$1.10/GJ on natural gas. These fee levels are specified in 1985\$ and are phased in over the period between 1985 and 2050.
- b. A percentage excise tax, proportional to the carbon content of the fuel, was levied on fuel use. Consumption taxes were also imposed in the RCWP case. In this case, the tax on coal consumption was increased from 28% of the price to 40%; the tax on oil use was increased from 20%-30%; the tax on natural gas use was increased from 13-20%; the tax on electricity use was increased from 0 to 5%. These taxes were phased in and fully applied by 2025.
- c. Assumes that the average efficiency of new cars in the U.S. reaches 50 mpg (4.7 liters/100 km) in 2000 and that global fleet-average auto efficiencies reach 65 mpg in 2025 (3.6 liters/100 km) and 100 mpg (2.4 liters/100 km) in 2050.
- d. Assumes that the rate of technical efficiency improvement in the residential and commercial sectors improves substantially beyond that assumed in the RCWP case. In this case, the rate of efficiency improvement in the residential and commercial sectors is increased so that a net gain in efficiency of 50% relative to the RCWP case is achieved in all regions.

- e. Assumes that, by 2050, average power plant conversion efficiency improves by 50% relative to the RCWP case. In this scenario the design efficiencies of all types of generating plants improve significantly. For example, by 2025, oil-fired generating stations achieve an average conversion efficiency roughly equivalent to that achieved by combined-cycle units today.
- f. The availability of commercial biomass was doubled relative to the assumptions in the RCWP case. In this case the rate of increase in biomass productivity is assumed to be at the high end of the range suggested by the U.S. DOE Biofuels Program. Conversion costs were assumed to fall by half relative to the assumptions in the RCWP case.
- g. Environmental fees of about \$20/GJ (in 1985 \$) are phased in by 2050. This has the effect of gradually making coal uncompetitive in utility markets.
- h. A rapid rate of global reforestation is assumed. In this case deforestation is halted by 2000 and the biota becomes a net sink for CO<sub>2</sub> at a rate of about 1 Pb C per year by 2025, about twice the level of carbon storage assumed in the RCWP case.
- i. Impact on warming when all of the above measures are implemented simultaneously. The impact is much less than the sum of the individual components because many of the measures are not additive.

- END -

22161  
25

NTIS  
ATTN: PROCESS 103  
5285 PORT ROYAL RD  
SPRINGFIELD, VA

22161

This is a U.S. Government publication, and the policies, views, or attitudes of the U.S. Government should not be cited or may cite FBIS or JPRS provided they do so in a manner clearly identifying them as the secondary source.

Foreign Broadcast Information Service (FBIS) and Joint Publications Research Service (JPRS) publications contain political, economic, military, and sociological news, commentary, and other information, as well as scientific and technical data and reports. All information has been obtained from foreign radio and television broadcasts, news agency transmissions, newspapers, books, and periodicals. Items generally are processed from the first or best available source; it should not be inferred that they have been disseminated only in the medium, in the language, or to the area indicated. Items from foreign language sources are translated; those from English-language sources are transcribed, with personal and place names rendered in accordance with FBIS transliteration style.

Headlines, editorial reports, and material enclosed in brackets [ ] are supplied by FBIS/JPRS. Processing indicators such as [Text] or [Excerpts] in the first line of each item indicate how the information was processed from the original. Unfamiliar names rendered phonetically are enclosed in parentheses. Words or names preceded by a question mark and enclosed in parentheses were not clear from the original source but have been supplied as appropriate to the context. Other unattributed parenthetical notes within the body of an item originate with the source. Times within items are as given by the source. Passages in boldface or italics are as published.

#### SUBSCRIPTION/PROCUREMENT INFORMATION

The FBIS DAILY REPORT contains current news and information and is published Monday through Friday in eight volumes: China, East Europe, Soviet Union, East Asia, Near East & South Asia, Sub-Saharan Africa, Latin America, and West Europe. Supplements to the DAILY REPORTs may also be available periodically and will be distributed to regular DAILY REPORT subscribers. JPRS publications, which include approximately 50 regional, worldwide, and topical reports, generally contain less time-sensitive information and are published periodically.

Current DAILY REPORTs and JPRS publications are listed in *Government Reports Announcements* issued semimonthly by the National Technical Information Service (NTIS), 5285 Port Royal Road, Springfield, Virginia 22161 and the *Monthly Catalog of U.S. Government Publications* issued by the Superintendent of Documents, U.S. Government Printing Office, Washington, D.C. 20402.

The public may subscribe to either hardcover or microfiche versions of the DAILY REPORTs and JPRS publications through NTIS at the above address or by calling (703) 487-4630. Subscription rates will be

provided by NTIS upon request. Subscriptions are available outside the United States from NTIS or appointed foreign dealers. New subscribers should expect a 30-day delay in receipt of the first issue.

U.S. Government offices may obtain subscriptions to the DAILY REPORTs or JPRS publications (hardcover or microfiche) at no charge through their sponsoring organizations. For additional information or assistance, call FBIS, (202) 338-6735, or write to P.O. Box 2604, Washington, D.C. 20013. Department of Defense consumers are required to submit requests through appropriate command validation channels to DIA, RTS-2C, Washington, D.C. 20301. (Telephone: (202) 373-3771, Autovon: 243-3771.)

Back issues or single copies of the DAILY REPORTs and JPRS publications are not available. Both the DAILY REPORTs and the JPRS publications are on file for public reference at the Library of Congress and at many Federal Depository Libraries. Reference copies may also be seen at many public and university libraries throughout the United States.